

StreamPunch VF Service Manual

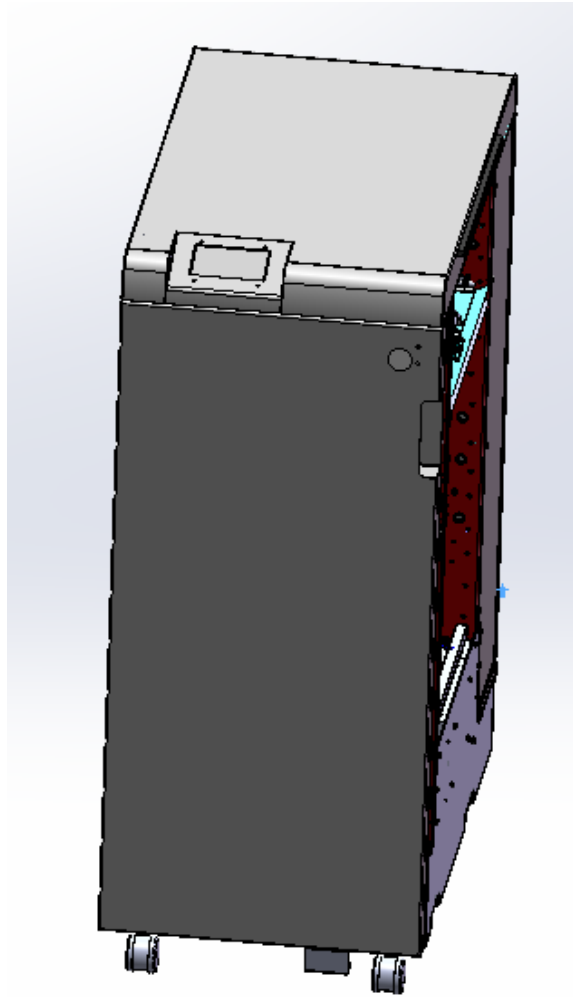

Table of Contents

NOTICE

All service documentation is supplied to external customers for informational purposes only. Service documentation is intended for use by certified, product trained service personnel only. GBC does not warrant or represent that such documentation is complete. GBC does not warrant or represent that it will notify or provide to such customer any future changes to this documentation. Service by the customer of the equipment, or modules, components, or parts of such equipment may void any otherwise applicable GBC warranties. If customer services such equipment, modules, components, or parts thereof, Customer releases GBC from any and all liability for actions by the Customer, and Customer agrees to indemnify, defend, and hold GBC harmless from any third party claims which arise directly or indirectly from such service.

Changes are periodically made to this document. Changes, technical inaccuracies, and typographic errors will be corrected in subsequent editions.

Copyright Notice

GBC
ACCO Brands Inc.
Four Corporate Drive
Lake Zurich, IL 60047.
USA

© Copyright 2014 by ACCO Brands Inc. All Rights reserved.

No part of this document may be photocopied or reproduced by any means, or translated to another language without prior written consent of GBC

All brand names, trademarks and registered trademarks are the property of their respective owners. Information contained within this document is subject to change without notice.

GBC products mentioned in this publication are registered trademarks of the ACCO Brands Corporation.

Title	Page
Service Call Procedures	
Introduction.....	iii
1. Service Call Procedures	1-1
2. Repair and Troubleshooting Procedures	2-1
3. Punch Quality	3-1
4. Adjustment and Replacement Procedures.....	4-1
5. Parts List	5-1
6. General Procedures	6-1
7. Wiring Data	7-1
8. Installation	8-1

Section Contents

Title	Page
Table of Contents.....	ii
Introduction	iii
Organization	iv
How to Use This Documentation	iv
Other Information	v
The Use of Caution, Warning, and Note statements.....	v
Safety Devices	vi
CAUTION	vi
Operational Safety.....	vi
Important safeguards	viii
Acronyms.....	ix

Organization

This documentation is divided into eight sections. In addition to the Introduction, this documentation contains the following sections.

Section 1	Service Call Procedures
Section 2	Repairs and Troubleshooting Procedures
Section 3	Punch Quality
Section 4	Adjustments and Replacement Procedures
Section 5	Parts List
Section 6	General Procedures
Section 7	Wiring Data
Section 8	Installation Checklist

How to Use This Documentation

Introduction

This section provides the Service Representative with information pertaining to the organization and use of this service documentation.

Section 1: Service Call Procedures

This section is used by the Service Representative as a structured process for determining the type and sequence of actions that are performed during a service call. The Service Call Procedures section is designed to assist in the effective recognition of machine symptoms and problems, as well as to provide instructions for the maintenance and corrective actions that are required to return the machine to the full operating condition

Section 1 of this service documentation is the entry level for all service calls. The Service Representative should begin each service call with the Initial Action Procedure found in Section 1.

The Service Call Procedures section is composed of five integral elements: Initial Action, System Checks, Every Call Activities, Scheduled Maintenance, and Final Action.

The maintenance and diagnostic activities in this section may direct the Service Representative to perform additional service activities found elsewhere in the documentation, such as RTPs, Replacement Procedures, and Adjustment Procedures.

Section 2: Repairs and Troubleshooting Procedures (RTP)

Section 2 of this documentation contains the Repair and Troubleshooting Procedures (RTPs) necessary to repair all faults associated with STREAMPUNCH VF. Service Representative will be referred to this section from some other section of this documentation during the service call. When a machine defect or fault has been resolved by using a RTP, the Service Representative should immediately return to the point in the service call from which Section 2 was entered. There are two types of RTPs found in Section 2. The first type is a RTP that is associated with the display of an error message in the RTP title. The second type is the Troubleshooting RTP. Troubleshooting RTPs are diagnostic procedures that are designed to address symptoms or problems that are not identified by, or associated with, a displayed status or fault code.

Section 3: Punch Quality

This section is used to diagnose punch quality defect problems.

Section 4: Adjustments and Repair Procedures (ARP)

This section contains all repair and adjustment procedures for the machine. Repairs (ARPs) and adjustments (ADJs) are identified by the use of a standard chain prefix number.

Section 5: Parts List

This section contains a list of spare parts for the machine. All parts list page reference numbers begin with the letters "PL", followed by a prefix number, a decimal point, and a sequential number used within the subsystem.

Section 6: General Procedures

This section contains procedures and information of a general nature that apply to the machine. This section is divided into two basic parts: General Procedures and General Information.

Section 7: Wiring Data

This section contains support information to assist in the electrical diagnosis of machine problems and is a central location for electrical wiring diagrams. This section is used in conjunction with other diagnostic or maintenance procedures that are contained in other sections of the service documentation.

Section 8: Installation

This section contains service information that supports the GBC STREAMPUNCH VF Installation.

Other Information

The Use of Caution, Warning, and Note statements

Information relative to the completion of a task in a safe or thorough manner will be supplied in the form of a Caution, a Warning, or a Note statement. These statements are found throughout the service documentation.

Cautions, Warnings, and Note statements appear before the steps to which they apply. These statements should be read before continuing to the next step in a procedure.

Caution - A Caution statement indicates an operating or maintenance procedure, practice, or condition that, if not strictly observed, could result in damage to, or destruction of, equipment.

Warning - A Warning statement indicates an operating or maintenance procedure, practice, or condition that, if not strictly observed, could result in personal injury or loss of life.

Note - A Note statement indicates an operating or maintenance problem, practice, or condition that is necessary to accomplish a task efficiently.

Safety Devices

The GBC STREAMPUNCH VF has door interlock to prevent personal injury when operating the machine.

When you open the Front Door, a Safety Interlock device automatically disables the drive motors until you close the Front Door.

When the Front Door is open, the Operator Panel displays the “CLOSE DOOR” message on the top line of the interface.

When you close the Front Door, the Operator Panel displays the “READY” message on the top line of the interface.

CAUTION

Certain components in the GBC STREAMPUNCH VF are susceptible to damage from electrostatic discharge. Observe all ESD procedures to avoid component damage.

Operational Safety

Do not operate the GBC STREAMPUNCH VF with the interlocks defeated.

Use care when a procedure in this Manual instructs you to “insert an Interlock Cheater into the Punch Door interlock Switch SW1,” in order to test the operation of a component.

WARNING

Moving Parts, keep hands clear of nips and the belts when the Interlock Cheater is inserted.



This safety message means you could get an electrical shock because disconnecting power from this section does not cut off power from adjacent sections of the machine.

⚠ ATTENTION	⚠ WARNING
Risque de secousse électrique. Ne pas ouvrir. Pas de pièces réparables par l'utilisateur. Entretien par personnel qualifié.	Electrical shock hazard. Do not open. No user serviceable parts inside. Refer servicing to qualified service personnel.
	
⚠ WARNUNG	⚠ MUCHO CUIDADO
Spannungsführende Teile. Nicht öffnen. Enthält keine vom Endverbraucher zu wartende Teile. Für Service bitte an qualifiziertes Service-Personal wenden.	Riesgo de choque eléctrico. No abra. Adentro, no hay piezas reparables para el usuario. Mantenimiento solamente para personal calificado.
⚠ WAARSCHUWING	⚠ ATTENZIONE
Kans op elektrische schok. Niet openen. Bevat geen door gebruik te repareren onderdelen. Door bevoegd servicepersoneel laten repareren.	Pericolo di scarica elettrica. Non aprire. Nessuna parte riparabile dall'utente. Chiamare un servizio di riparazioni qualificato.

This safety message means that you might get seriously hurt or killed if you open the product and expose yourself to hazardous voltage. NEVER remove the screwed on covers. ALWAYS refer service requirements to qualified service personnel.

Important safeguards

- ◆ Use STREAMPUNCH VF only for its intended purpose of punching paper and covers according to the indicated specifications.
- ⚠ CAUTION: THE PRINTER ON/OFF SWITCH DOES NOT CUT OFF POWER FROM THE PUNCH.
- ◆ The Punch must be connected to a supply voltage corresponding to the electrical rating of the machine operation instructions (also listed on the serial number label).
- ◆ The grounding plug is a safety feature and will only fit into the proper grounding-type power outlet. If you are unable to insert the plug into an outlet, contact a qualified electrician to have a suitable outlet installed.
- ◆ Do not alter the plug on the end of the cordset (if provided) of the Punch. It is provided for your safety.
- ◆ Unplug the Punch before moving the machine or whenever the machine is not in use for an extended period of time.
- ◆ Do not operate the Punch if the machine has a damaged power supply cord or plug. Do not operate the machine after any malfunction. Do not operate the machine in case of liquid spills, or if the machine has been damaged in any other way.
- ◆ Do not overload electrical outlets beyond their capacity. To do so may result in fire or electrical shock.

Do not open any panels other than those indicated by this Manual.

- Pay particular attention to the WARNINGS and CAUTIONS listed in the Operator Manual and Service Manual.

Acronyms

Acronyms are used in the parts list to provide information in a limited amount of space. The following table lists the abbreviations used in this manual:

Acronym	Meaning
CBL	Cable
DRV	Motor Driver (Stepper Board)
F	Fuse
FAN	Fan
GND	Ground
M	Motor
P	Plug
J	Connector
PSU	Power Supply
S	Sensor
SW	Switch
SOL	Solenoid
UI	User Interface

Notes:

1. Service Call Procedures

Section Contents

Service Call Procedures

Title	Page
CALL FLOW	1-2
INITIAL ACTION	1-3
SYSTEM CHECKS	1-3
EVERY CALL ACTIVITIES	1-4
SCHEDULED MAINTENANCE	1-4
PREVENTATIVE MAINTENANCE	1-4
MAINTENANCE SCHEDULE	
Customer Maintenance.....	1-5
Periodic Maintenance	1-5
Periodic Replacement.....	1-6
HFSI.....	1-7
FINAL ACTION	1-7

CALL FLOW

INITIAL ACTION

This step is used to gather information about the reason for the call, to determine the machine condition, and to run a sample if possible



SYSTEM CHECKS

This step is used to suggest a direction for using the information obtained during Initial Action. You can then repair and verify the repair of the problem. This step may also provide information to assist in the identification of new problems and suggest actions to take to repair/resolve them.



FINAL ACTIONS

This step is used to ensure that the punch quality, the punch performance, and the punch appearance are satisfactory. It will also provide direction to help complete administrative tasks.

INITIAL ACTION

At the start of every service call, you should perform the following.

1. If called for a problem, determine the exact nature of the service complaint. Determine the paper type and quality, especially as it relates to curl and identify if any media changes correlate with the emergence of the customer issue.
2. Press INFO to note down the total machine punch cycles.
3. Press INFO to check the cycle life on the Die Set installed in the STREAMPUNCH VF.
4. If any of the Die Set life cycles have exceeded the die life (typically 750,000 cycles) go to Section 3 and check the Hole Quality.
 - If the Hole Quality is acceptable monitor the Hole Quality frequently to ensure that the Hole Quality is okay.
 - If the Hole Quality is not acceptable replace the Die Set.
 - Hole Quality is not guaranteed if the die is past its expected life
5. Determine if the customer uses only one Die Set or if they switch between different Die types.
6. Determine the last time the Die Set was lubricated. Perform GP 6.7.3 to lubricate die if necessary.
7. Determine the date of the last preventative maintenance performed on the punch system. Perform Preventative Maintenance using the *STREAMPUNCH VF Maintenance Schedule* on page 1-5 if needed.
8. Vacuum all paper path, punch, dust box area of scrap/debris.

SYSTEM CHECKS

Purpose

Direct repair activity for problems found in Initial Action.

PROCEDURE

1. Select the appropriate condition from the list below and perform the directed service actions.
 - Replace any obviously broken parts.
 - If there is a Punch Quality problem, go to Section 3.
 - If there is a Fault Code, go to Section 2 Table of Contents. Locate and perform the FAULT CODE RTP associated with the Fault Code.
 - If there is an Operator Message that will not clear, go to Section 2 Table of Contents. Locate and perform the steps in the OPERATOR MESSAGE RTP associated with the Operator Message.
 - If there is No Fault Code or Operator Message associated with the problem, go to Section 2 Table of Contents. Locate and perform the OTHER FAULTS RTP which most closely matches the problem described by the customer.
 - If the problem is not repeatable, operate the STREAMPUNCH VF in the same job conditions the customer used and recheck for a problem in the categories listed here.
 - If the problem is still not reproduced, examine the Machine Service Log and note any repeating faults. Refer to the RTP for those faults in Section 2 to check if the RTP relates to the customer problem. If so, perform the RTP.
 - If none of the above situations apply, go to EVERY CALL ACTIVITIES.
2. Verify that the problem is corrected and go to EVERY CALL ACTIVITIES.

EVERY CALL ACTIVITIES

Purpose

List service activities required on every service call.

PROCEDURE

1. Perform GP 6.5 Operational Inspection.
2. Perform GP 6.6 Internal Inspection.
3. Perform GP 6.8 External Cleaning.
4. Perform GP 6.9 Internal Cleaning
5. Perform GP 6.10 Base Cleaning
6. Perform GP 6.11 Chip Bin Cleaning
7. Perform GP 6.12 Die Guide Cleaning
8. Perform GP 6.17 Optical Sensor Cleaning

SCHEDULED MAINTENANCE

PROCEDURE

1. Press INFO to check the cycle life on the Die Set installed in the STREAMPUNCH VF.
2. See the STREAMPUNCH VF Maintenance Schedule on page 1-5.

PREVENTATIVE MAINTENANCE

Purpose

If operating properly, the STREAMPUNCH VF will punch the same types of copy paper and cover materials handled by the printer and run at the same speed.

Hole quality will vary between different grades of paper.

See the *STREAMPUNCH VF Maintenance Schedule* on page 1-5.

STREAMPUNCH VF Maintenance Schedule

Note: cycles = sheets of paper punched, not impressions.

Customer Maintenance

Area/Unit	Period	See:	Measures	Remarks
Punch Die	100K Die cycles	GP 6.7.3	Lubrication	Oil the punch pins
Die set shoulder bolts	200k Die cycles	GP 6.7.4	Inspect and lubricate	Grease

Periodic Maintenance

Area/Unit	Period	See:	Measures	Remarks
Punch Drive Cams	5000K cycles	GP 6.20	Inspect and lubricate	
Punch Motor Belt	1,000K cycles	GP 6.21	Inspect	
Alignment Stepper Belt	1,000K cycles	GP 6.21	Inspect	
Steering Carriage Belt	1,000K cycles	GP 6.21	Inspect	
Steering Rollers	1,000K cycles	GP 6.14	Inspect and clean	Alcohol and Cloth
Punch Clutch	1,000K cycles	GP 6.24	Clean	Cloth
Sensors S1 to S28	500K cycles	GP 6.17	Clean	Air
Drive and Idler Rollers	1,000K cycles	GP 6.14 & GP 6.15	Inspect and clean	Alcohol & cloth
Solenoid Module	1,000K cycles	GP 6.22	Inspect	
Idler Panel Closing Magnet Latches	1,000K cycles	GP 6.16	Inspect	
Acceleration Panel Latch	1,000K cycles	GP 6.16	Inspect	
Paper Path Drive Timing Belts	1,000K cycles	GP 6.21	Inspect and Adjust if necessary	
Diverter Solenoid Assembly	1,000K cycles	GP 6.25	Inspect	
Die Set Recognition Board Clips	1,000K cycles	GP 6.26	Clean	Cloth
Alignment Carriage Rails	500K Cycles	GP 6.24	Inspect and Clean	Air and Cloth
Die Lock Mechanism and Die Rail Springs	1000K Cycles	GP 6.27	Inspect	
Die guide (rail) cleaning	500K cycles	GP 6.12	Clean	Vacuum
Paper path	1000K cycles	GP 6.18 & GP 6.19	Inspect and clean	Cloth

Periodic Replacement

Area/Unit	Part Number	No. of pcs.	Rough Standard	Remarks
Die Set	See PL 5-1	1	750K Cycles	Replace as needed
Punch Module	7715710 (115V) 7715810 (230V)	1	15M Cycles	Replacement
Solenoid module	7715223	6	5M Cycles	Replacement
Perf Die Backing		1	375K Cycles	Replace

HFSI

Replace the part if over threshold (See Pages 1-5 and 1-6).

Note down the DIE CYCLE counts and PUNCH CYCLE count when performing HFSI.

FINAL ACTION

This section explains the actions a technician should take at the end of every service call. With each step, verify that the system runs smoothly and paper jam free.

Purpose

Ensure acceptable punch quality, punch performance, and punch appearance are satisfactory and to complete administrative tasks.

PROCEDURE

1. Install/close all covers and doors.
2. Inspect each Die Set visually and lubricate as needed. See GP 6.7, Die Set Service
3. Use the customer's primary Die Set pattern to run 200 simplex printed test sheets through the punch mode and examine the output for clean hole quality and even hole alignment.
4. Use the customer's primary Die Set pattern to run 200 duplex printed test sheets through the punch mode and examine the output for clean hole quality and even hole alignment.
5. Use any of the customer's secondary Die Set pattern to run 100 simplex printed test sheets through the punch mode and examine the output for clean hole quality and even hole alignment.
6. Run 100 sheets simplex and 100 sheets duplex through the punch bypass mode.
7. Clean out all paper chips (chad) and paper dust from the chip tray, the bottom of the machine and from the floor around the bottom of the machine. See GP 6.10 Base Cleaning.
8. Explain to the customer the service work that was performed and ensure they are satisfied before you close the call.

Service Call Close

1. Record your service activities along with the Punch Cycle Count.

Notes:

2. Repair and Troubleshooting Procedures (RTPS)

Section Contents

Title	Page
Introduction	2-3
Troubleshooting Start Guide	2-4
OPERATOR MESSAGES	2-5
Top Row of Text.....	2-5
Bottom Row of Text.....	2-5
Check Die.....	2-6
Close Door	2-8
Chip Tray Out.....	2-9
Chip Tray Out message is not displayed when the Chip tray is out	2-9
Chip Tray Full.....	2-10
ERROR CODES	2-11
ERROR E450 DIE TYPE/CODE INVALID	2-11
ERROR E451 DIE ENCRYPTION ERROR	2-12
ERROR E452 INCOMPATIBLE DIE	2-12
FAULT CODES	2-13
Fault Code Text.....	2-13
Fault Code Areas	2-13
Fault Code and Jam Type.....	2-14
PAPER JAM J126	2-14
PAPER JAM J101	2-14
PAPER JAM J125	2-14
PAPER JAM J202	2-14
PAPER JAM J203	2-14
PAPER JAM J204	2-14
PAPER JAM J220	2-14
PAPER JAM J221	2-14
PAPER JAM J218	2-14
PAPER JAM J219	2-14
PAPER JAM J305	2-14
PAPER JAM J316	2-14
PAPER JAM J317	2-14
PAPER JAM J411	2-14
PAPER JAM J412	2-14
PAPER JAM J413	2-14
PAPER JAM J414	2-14
PAPER JAM J415	2-14
PAPER JAM J506	2-14
PAPER JAM J507	2-14
PAPER JAM J508	2-14
PAPER JAM J509	2-14
PAPER JAM J510	2-14
PAPER JAM J622	2-14
PAPER JAM J623	2-14
PAPER JAM J624	2-14
PAPER JAM J625	2-14
PAPER JAM J999	2-14
Jam Types.....	2-15
1 POWER FAULTS	2-16
RTP 1.1 No AC Power.....	2-16
RTP 1.2 No DC Power.....	2-18
RTP 1.3 Operator Panel Does Not Illuminate.....	2-19
RTP 1.4 Operator Panel Does Not Show Text... Error! Bookmark not defined.	
RTP 1.5 Up, Down, Enter Keys Do Not Respond Error! Bookmark not defined.	
2 PAPER JAMS	2-20
RTP 2.1 Jam Type A	2-20
RTP 2.2 Jam Type B	2-21
RTP 2.3 Jam Type C	2-22
RTP 2.4 Jam Type D	2-24
RTP 2.5 Jam Type E	2-25
RTP 2.6 Jam Type F.....	2-26
RTP 2.7 Multiple Sheets Jammed - Die Pins Partially Through the Sheets	2-27
RTP 2.8 Checking Obstruction in Paper Path	2-28

3	SENSOR CHECKS	2-31
RTP 3.1	Check Sensors S1, S2, S3, S4, S5, S22, S23, S24, S25, S26	2-31
	Sensor Cables.....	2-33
RTP 3.2	Check Sensors S6 to S21	2-34
RTP 3.3	Checking Sensor S28 Align Home Sensor	2-39
4	SOLENOID CHECKS	2-41
RTP 4.1	Check Solenoid SOL 1	2-41
RTP 4.2	Check Solenoid SOL 2.....	2-41
RTP 4.3	Check Solenoids SOL 3 to SOL 8.....	2-42
5	MOTOR CHECKS	2-44
RTP 5.1	Checking Stepper Motors.....	2-44
6	OTHER FAULTS	2-46
RTP 6.1	Die Set Will Not Slide In or Out Easily	2-46
RTP 6.2	Punch Overheats	2-46

Introduction

This section contains the Repair and Troubleshooting Procedures (RTPs).

Organization

This section lists the Repair Analysis Procedure (RTP) for each Operator Message and Fault Code. In some cases, one Repair Analysis Procedure may apply to several Fault Codes. In those cases, subsequent Fault Codes include a cross reference to the pertinent RTP.

To help you locate each component, the Repair and Troubleshooting Procedures include part locators (PL x.y) that refer to the pertinent page in Section 5, Part List.

OPERATOR MESSAGES

The Operator Panel displays status messages and fault codes on two rows of text.

Top Row of Text

Message	Description	Action
CLOSE DOOR	The Front Door is open.	Close the Front Door.
READY	The system is ready.	Use the Punch to punch paper or bypass the Punch.

Middle Row of Text

Message	Description	Action
CHECK DIE	Check the Die Set	Check the Die Set
BYPASS	The Punch is in Bypass Mode	Use the Punch in Bypass Mode.
[OPERATION MODE]	Indicates which operation is currently in process	The machine will operate in the selected mode

Lower Rows of Text

Die Type

Displays the currently installed Die Type for reference.

Mode

Displays the currently selected operation mode for reference. All sheets sent to the machine will be processed according to this mode unless a change is made.

Check Die

The CHECK DIE message indicates that the Die Set is either missing or not fully installed.

1. Open the Front Door.
2. Unlock the Dieset, and remove the Dieset (see STREAMPUNCH VF User Manual).
3. Re-insert the Dieset and lock the lock it in place.

This clears the fault code.

Yes- Normal operation; **No-** Go to step 4.

4. Do ARP 1.6 to remove the Rear Cover, and check if the Dieset Recognition Reader Board Cable (7715495) is connected properly at both ends (see PL 6.4 or Section 7 wiring). Note that the connector has 4 pins, and it should be properly inserted.

This clears the fault code.

Yes- Normal operation; **No-** Go to step 5.

5. Clean the Dieset Recognition Board in the Die and the Die set Recognition Reader Board in the machine.

This clears the fault code.

Yes- Normal operation; **No-** Go to step 6

6. Check if the Dieset Recognition Reader Board Spring Clips contact the Dieset Recognition Board in the Dieset.

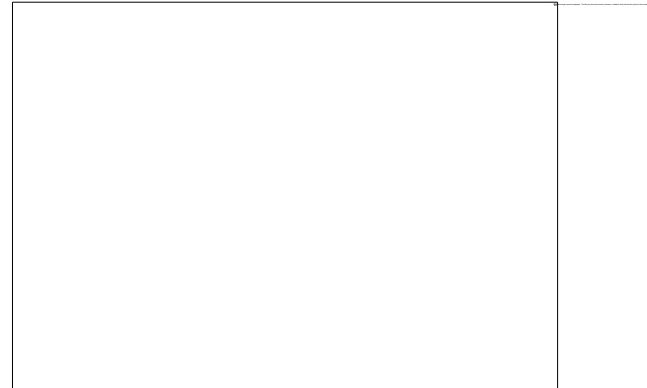

If Spring Clips are broken, Replace Dieset Recognition Reader Board. If the springs clips do not contact the Dieset Recognition Board, do ADJ 1.6 Dieset Recognition Board Adjustment.

This clears the fault code.

Yes- Normal operation; **No-** Go to step 7.

7. If there is another Dieset, check if that Dieset shows the same message.

Dieset shows the same message.

Yes- If the error is still present with all the diesets, do GP 6.2.12 *FIRMWARE UPGRADE Procedure* to reflash the firmware.

No- If the issue is with just one Dieset, then escalate to next level

This clears the fault code.

Yes- Normal operation; **No-** Go to Step 8.

8. Replace the Dieset Recognition Cable #7715495 (Section 7 Wiring).

This clears the fault code.

Yes- Normal operation; **No-** Go to step 9.

9. Do ARP 3.27 to Replace the Dieset Recognition Reader Board Assembly (PL 4.9).

This clears the fault code.

Yes- Normal operation; **No-** Go to step 10.

10. Do ARP 5.1 *Main Control Board Replacement* to Replace the Main Control Board (PL 6.1).

This clears the fault code.

Yes- Normal operation; **No-** Escalate to next level.

Close Door

The CLOSE DOOR message indicates that the Front Door is open or not completely closed.

1. Check that the Front Door is closed.
The Front Doors is closed.
Yes- Go to step 2;
No- Close the Front Door and return to normal operation.
2. Insert an Interlock Cheater into the Punch Door interlock Switch SW4 (PL 1.2).

WARNING

Moving Parts, keep hands clear of nips and the belts when the Interlock Cheater is inserted.

3. Check if the Close Front Door message is displayed.
The Close Front Door message is displayed.
Yes- Go to Step 4;
No- Do ADJ 1.1 Door Latch adjustment and return to normal operation
4. Do ARP 1.6 to remove the Rear Cover and check if the Interlock Cable 7715487 is connected at J8 at the Main Control Board (PL 6.1).
Interlock Cable is connected at J8.
Yes- Go to step 5;
No- Make the connection and return to normal operation.
5. Switch OFF the machine and unplug the Power Cord.
6. Remove the M4 Nuts (2) that hold the Interlock Switch Bracket (PL 1.2) and inspect the connections at the Interlock Switch (see ARP 1.11 Interlock switch Replacement for photos of the connections).
Interlock cable is connected at the Interlock switch.
Yes- Go to step 7;
No- Make the connection and return to Normal operation.

7. Inspect the connection at J17 at the Main Control Board. It is a 16 pin connector to a 16 pin terminal.

The connection at J17 is good.

Yes- Go to step 8;

No- Make the connection and return to normal operation.

8. Do GP 6.2.12 Firmware Upgrade procedure to re-flash the Firmware for Advanced Punch Pro,

Re-flashing the firmware clears the fault.

Yes- Return to normal operation; **No-** Go to step 9

9. Do ARP 1.11 Interlock Switch Replacement to Replace the Interlock switch.

Replacing the switch clears the fault.

Yes- Return to normal operation; **No-** Go to step 10.

10. Replace Interlock Switch Cable 7715487.

Replacing the cable clears the fault.

Yes- Return to normal operation;

No- Replace the Main Control Board (PL 6.1).

Chip Tray Out

This message is displayed when the Chip tray is removed from the machine or when the chip tray is not fully inserted.

Use this procedure when the Chip Tray Out message is displayed when the Chip tray is inserted.

1. Open the Front door and insert the Chip Tray firmly.
This clears the fault.
Yes- Return to normal operation; **No-** Go to step 2
2. Inspect if the Spring Clip of the Chip tray home switch. If the Spring Clip is broken, do ARP 3.2 Chip Tray Home Switch Replacement.
This clears the fault.
Yes- Return to normal operation; **No-** Go to step 3
3. Do GP 6.2.12 Firmware Upgrade procedure to re-flash the Firmware for Advanced Punch Pro,
Re-flashing the firmware clears the fault.
Yes- Return to normal operation; **No-** Go to step 4
4. Do ARP 3.2, Replace Chip Tray Home Switch,
This clears the fault.
Yes- Return to normal operation; **No-** Go to step 5
5. Replace Cable 7715485 (See Section 7 Wiring).
This clears the fault.
Yes- Return to normal operation;
No- Do ARP 5.1 *Main Control Board Replacement* to Replace the Main Control Board (PL 6.1).

Chip Tray Out message is not displayed when the Chip tray is out

This message is displayed when the Chip Tray Out message is not displayed when the Chip tray is out.

1. Make sure the (2) spade connectors to the Chip tray home switch is securely inserted. (see ARP 3.2 for details)
Connectors are securely connected.
Yes- Go to step 2; **No-** Securely connect the (2) spade connectors
2. Do ARP 1.6 to remove the Rear Cover and check the 7715485 cable is connected to J27 at the Main Control Board (Section 7 Wiring)
See the *Sensor Cables* table on page 2-33 for cable numbers.
The connection is good.
Yes- Go to step 3;
No- Make the connection and return to normal operation.
3. Do GP 6.2.12 Firmware Upgrade procedure to re-flash the Firmware for Advanced Punch Pro,
Re-flashing the firmware clears the fault.
Yes- Return to normal operation; **No-** Go to step 4
4. Do ARP 3.2, Replace Chip Tray Home Switch,
This clears the fault.
Yes- Return to normal operation; **No-** Go to Step 5
5. Replace Cable 7715485.
This clears the fault.
Yes- Return to normal operation
No- Do ARP 5.1 *Main Control Board Replacement* to Replace the Main Control Board (PL 6.1).

Chip Tray Full

The Chip Tray full message is displayed when the punch chips fill the chip tray and the capacity is exceeded.

1. Remove the Chip tray and empty the punch chips.

This clears the fault.

Yes- Return to normal operation **No-** Go to Step 2

2. Clean the Chip Level Emitter and Chip Level Receiver Sensors (PL 2.5). Ensure the sensor path is clear with the Chip Tray installed.

The Chip Level Emitter and Receiver Sensors are located in the Chip Tray cavity in the lower portion of the front frame. See ARP 3.3 and 3.4 for more details.

This clears the fault

Yes- Return to normal operation **No-** Go to Step 3

3. Remove the Chip Tray and check if the Chip level Emitter and Chip level Receiver are plugged in.

The Chip level emitter and receiver are located in the Chip tray cavity in the lower portion of the front frame. See ARP 3.3 and ARP 3.4 for more details.

See the *Sensor Cables* table on page 2-33 for cable numbers.

The connections are good.

Yes- Do ARP 1.6 to remove the Rear Cover and go to Step 4.

No- Make the connection and return to normal operation.

4. Check if Cable 7715485 is connected to J27 at the Main Control Board (Section 7 Wiring).

The connection is good.

Yes- Go to Step 5

No- Make the connection and return to normal operation.

5. Do GP 6.2.12 Firmware Upgrade procedure to re-flash the Firmware for Advanced Punch Pro,

Re-flashing the firmware clears the fault.

Yes- Return to normal operation **No-** Go to Step 6

6. Do ARP 3.3 to Replace the Chip Level Emitter (PL 2.5).

This clears the fault

Yes- Return to normal operation **No-** Go to Step 7

7. Do ARP 3.3 to Replace the Chip Level Receiver (PL 2.5).

This clears the fault.

Yes- Return to normal operation **No-** Go to Step 8.

8. Replace cable 7715485 (Section 7 Wiring)

This clears the fault.

Yes- Return to normal operation

No- Do ARP 5.1 to Replace the Main Control Board (PL 6.1).

ERROR CODES

The User Interface displays two error messages when the firmware detects that an item is bad or not functioning. There are only 3 error codes.

Error Code	Description
E450	Die type/code invalid
E451	Die encryption error
E452	Incompatible die

ERROR E451
DIE ENCRYPTION ERROR

The top row of text displays the fault error message number the bottom row displays the description.

NOTE: If there is an ERROR message when downloading firmware (either PM_XX_XX.BIN or PC_XX_XX.BIN file), the firmware should be downloaded again.

ERROR E450 DIE TYPE/CODE INVALID

This means that the die type is incorrectly set in the die set.

1. Open the Front Door.
2. Remove the Die Set (see User Manual).
3. Check that the Die Set is the correct Die Set for the Punch.
The Die Set is the correct die Set for the Punch.
Yes- Go to Step 4 **No-** Replace the Die Set
4. Slowly re-insert the die set into the machine and close the front door.
This clears the fault.
Yes- Resume normal operation
No- Replace the Die Set and escalate to next level.

ERROR E451 DIE ENCRYPTION ERROR

This means that the die is not a GBC certified die or the dieset was not read properly.

1. Open the Front Door.
2. Remove the Die Set (see STREAMPUNCH VF User Manual).
3. Check that the Die Set is the correct Die Set for the Punch.

The Die Set is the correct die Set for the Punch.

Yes- Go to Step 4 **No-** Replace the Die Set

4. Slowly re-insert the die set into the machine and close the front door.

This clears the fault.

Yes- Resume normal operation

No- Replace the Die Set and escalate to next level.

ERROR E452 INCOMPATIBLE DIE

This means the die is not a certified Ricoh die.

1. Open the Front Door.
2. Remove the Die Set (see STREAMPUNCH VF User Manual).
3. Check that the Die Set is the correct Die Set for the Punch.

The Die Set is the correct die Set for the Punch.

Yes- Go to Step 4 **No-** Replace the Die Set

4. Slowly re-insert the die set into the machine and close the front door.

This clears the fault.

Yes- Resume normal operation

No- Replace the Die Set and escalate to next level.

FAULT CODES

The User Interface displays Fault codes on two rows of text.

PAPER JAM J622

CLEAR 6

The top row of text displays the fault code.

The bottom row of text displays the area of the Punch where the error occurred.

Fault Code Text

Each Fault code starts with the letter “J” followed by a 3-digit code.

Fault Code Areas

When you open the Front Door, the front panel of the Punch is labeled to identify the location of the six (6) areas of the machine. These numbers match the numbers in the bottom row of text.

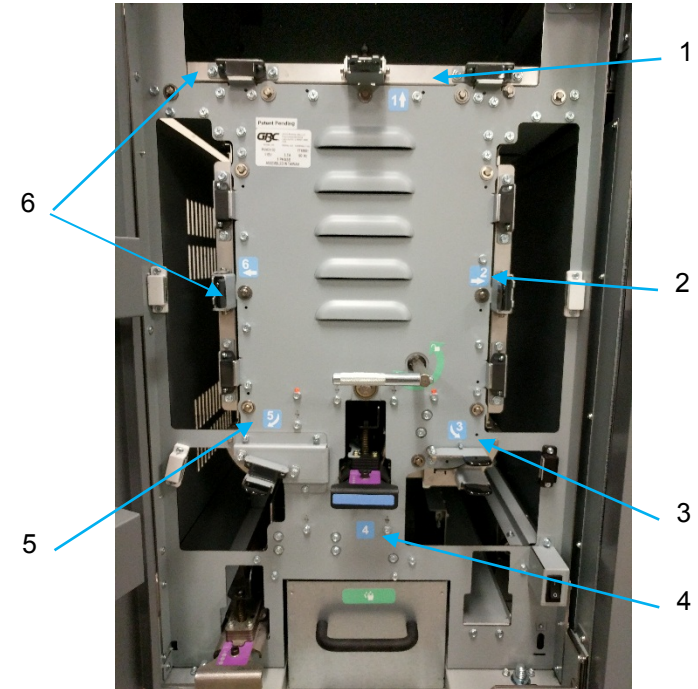

Bottom Row of Text	Area	General Location
Clear 1	Area 1	Bypass Section
Clear 2	Area 2	Entrance Idler Section
Clear 3	Area 3	Acceleration Roller Section
Clear 4	Area 4	Punch Module
Clear 5	Area 5	Lower Punch Exit Section
Clear 6	Area 6	Exit Idler Section

Fault Code and Jam Type

The following table lists each Fault Code, and the corresponding Jam Type.

The table on the next page shows the RTP for each jam type.

To clear a jam, see the second line of the LCD display.

The display will indicate which area(s) to Clear jammed paper (Example-CLEAR 1,2,3).

Fault Code	Jam Type
PAPER JAM J126	F
PAPER JAM J101	A (if punch job); F (if bypass job)
PAPER JAM J125	A (if punch job); F (if bypass job)
PAPER JAM J202	B
PAPER JAM J203	B
PAPER JAM J204	B
PAPER JAM J220	B
PAPER JAM J221	B
PAPER JAM J218	B
PAPER JAM J219	B
PAPER JAM J305	C

Fault Code	Jam Type
PAPER JAM J316	C
PAPER JAM J317	C
PAPER JAM J411	C
PAPER JAM J412	C
PAPER JAM J413	C
PAPER JAM J414	C
PAPER JAM J415	C
PAPER JAM J506	D
PAPER JAM J507	D
PAPER JAM J508	D
PAPER JAM J509	D
PAPER JAM J510	D
PAPER JAM J622	E
PAPER JAM J623	E
PAPER JAM J624	E
PAPER JAM J625	E (if punch Job); F (if bypass job)
PAPER JAM J999	Unspecified jam

The Jam Types table on the next page describes each Jam type. Read the description and make sure it matches the nature of the paper jam in the machine. If it does not match the description, chose the appropriate RTP based on the information provided below.

If there is no jammed paper in the unit and there is a Fault code, use the RTP based on the jam type specified on the Fault Code and Jam Type table above.

Jam Types

The following table lists each paper jam type. It lists Jam Type (A, B, C, etc.) and the corresponding description (position of first jammed sheet).

Jam Type	Description	RTP
Jam Type A	The lead edge of the first jammed sheet is stopped by nip N1	Do RTP 2.1 Jam Type A
Jam Type B	The lead edge of the first jammed sheet is stopped past nip N1 but before nip N5.	Do RTP 2.2 Jam Type B
Jam Type C	The lead edge of the first jammed sheet is stopped past nip N5 but before Steering Rollers N6 and N7	Do RTP 2.3 Jam Type C
Jam Type D	The lead edge of the first jammed sheet is past N6 and N7 but its trail edge is before or just past N6/N7.	Do RTP 2.4 Jam Type D
Jam Type E	The trail edge of the first jammed sheet is past Steering rollers N6 and N7	Do RTP 2.5 Jam Type E
Jam Type F	The paper jam is in the Bypass Assembly.	Do RTP 2.6 Jam Type F

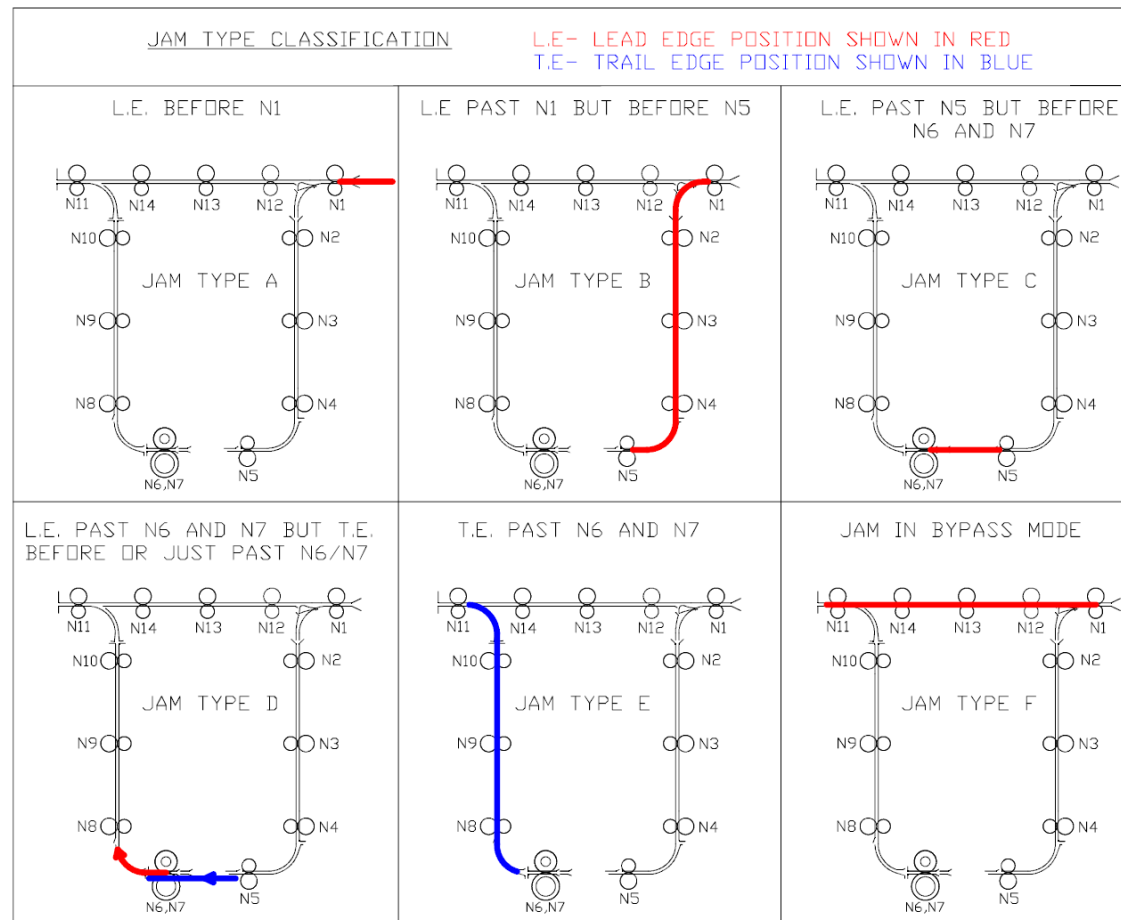

1 POWER FAULTS

RTP 1.1 No AC Power

Use this RTP when there is no AC power to the STREAMPUNCH VF. The Operator Panel does not illuminate and the STREAMPUNCH VF does not operate.

1. Check that the Power Cord is attached to the AC Filter on the rear of the machine.

Power Cord is attached to AC Filter.

Yes- Go to Step 2 **No-** Attach the Power Cord.

2. Check that the Power Cord is properly plugged into the wall.

Power Cord is plugged into the wall.

Yes- Go to Step 3 **No-** Plug in the Power Cord.

3. Disconnect the Power Cord from the power source and check for input voltage - 110 VAC (60 Hz) or 240 VAC (50 Hz) - at the power receptacle.

AC power is present at the receptacle.

Yes- Go to Step 4

No- If there is no power at the outlet, ask the customer to call an electrician to restore the AC power.

4. Reconnect the power cord to STREAMPUNCH VF.

5. Check that Ground Wire 7715525 is connected to the ground and to the AC Filter.

Ground Wire 7715525 is connected.

Yes- Go to Step 6 **No-** Connect Ground Wire 7715525.

6. Check that Cable 7715498 is connected at the AC filter.

Cable 7715498 is connected at the AC filter.

Yes- Go to Step 7 **No-** Connect Cable 7715498.

7. Check that Cable 7715498 is connected to the Communication board at Pin J14.

Cable 7715498 is connected to the Communication board.

Yes- Go to Step 8

No- Connect Cable 7715498 to the ELCB.

8. Check the Fuse on the Communications Board.

Fuse is okay

Yes- Go to Step 9 **No-** Replace the Fuse (PL 6.1).

9. Check that Wire 7715494 is connected to Pin J15 on the Communications Board.

Wire 7715494 is connected to Pin J15 on the Communications Board.

Yes- Go to Step 10

No- Connect Wire 7715494 to Pin J15 on the Communications Board.

10. Check that Wire 7715494 is connected to Pin J4 on the Control Board.

Wire 7715494 is connected to Pin J4 on the Control Board.

Yes- Go to Step 11

No- Connect Wire 7715494 to Pin J4 on the Control Board.

11. Check for input voltage - 110 VAC (60 Hz) or 240 VAC (50 Hz) - at the AC Filter.

There is AC power at the AC Filter.

Yes- Go to Step 12

No- Replace the AC power cord to the AC Filter (PL 7.1).

12. Check for input voltage - 110 VAC (60 Hz) or 240 VAC (50 Hz) – on Cable 7715498 at the AC Filter (BRN & BLU wires).

There is AC power on Cable 7715498 at the AC Filter.

Yes- Go to Step 13 **No-** Replace AC FILTER (PL 6.1).

13. Check for input voltage - 110 VAC (60 Hz) or 240 VAC (50 Hz) – on Cable 7715498 at the Pin J14 on the Communications Board (BRN & BLU wires).

There is AC power on Cable 7715498 at Pin J14 on the Communications Board.

Yes- Go to Step 14 **No-** Replace Cable 7715498.

14. Check for input voltage - 110 VAC (60 Hz) or 240 VAC (50 Hz) – on Cable 7715494 at Pin J15 on the Communications Board (BLU & BRN wires).

There is AC power on Cable 7715494 at Pin J15 the Communications Board.

Yes- Go to Step 15

No- Replace the Communications Board (ARP 5.2).

15. Check for input voltage - 110 VAC (60 Hz) or 240 VAC (50 Hz) – on Cable 7715494 at Pin J4 on the Control Board (BLU & BRN wires).

There is AC power on Cable 7715494 at Pin J4 the Control Board.

Yes- Replace the Main Control Board (ARP 5.1).

No- Replace Cable 7715494

RTP 1.2 No DC Power

Use this RTP when there is no indication of 24 VDC power.

1. Do ARP 1.6 to remove the Rear Cover.
2. Plug in the AC power cord and turn ON the AC power switch.

WARNING

Moving Parts, keep hands clear of nips and the belts when the Interlock Cheater is inserted.

3. Check the LEDs on the Control Board.
 - With the front door closed LED3 24V will be lit and LED2 24VI will be lit
 - With the front door open, LED 3 24V will be lit but LED2 24VI will not be lit.

The LEDs are lit.

Yes- Go to step 9 **No-** Go to step 4.

4. Check for line voltage on Wire 7715493 at Connector J3 on the Main Control Board (Section 7 Wiring).

There is line voltage.

Yes- Go to Step 5 **No-** Do RTP 1.1 No AC Power.

5. Check the following connections:
 - Connection of cable 7715492 at J1 at the Main Control Board.
 - Connection of cable 7715493 at J3 at the Main Control Board.

Connections are good.

Yes- Go to Step 6

No- Make the connections then return to normal operation.

6. Do ARP 4.1 to remove 24 VDC Power Supply.
7. With the power supply outside the machine, make the connections at J1 and J3 and the ground cable.

WARNING

Do not touch the open terminals of the power supply or any other connector with the AC power cord connected. The machine components contain dangerous electrical voltages that can result in electrical shock and possible serious injury.

8. Check if the LED in the power supply is lit.

LED is lit

Yes- Go to Step 10 **No-** Go to Step 9

9. Replace Cable 7715493

This clears the fault.

Yes- Return to normal operation

No- Replace the 24V DC power supply (PL 4.1)

10. Check if there is no 24V power to any other components like a Solenoid, or a Stepper Motor,

There is no 24V power to any other components

Yes- Replace the Main Control Board (PL 6.1)

No- Go to Step 11

11. Check for 24 VDC on Cable 7715492 at Connector J1 on the Control Board.

- Pin 1 = ORG Wire
- Pin 2 = ORG Wire
- Pin 3 = ORG Wire
- Pin 6 = BLK Wire
- Pin 7 = BLK Wire
- Pin 8 = BLK Wire

There is 24 VDC at Connector J1 on the Control Board

Yes- Go to Step 12 **No-** Replace Cable 7715492.

12. Determine if you have been directed here from another RTP because there is no 24 VDC power output from the Control Board to another component.

There is no 24 VDC power output from the Control Board to another component.

Yes- Replace the Main control board (PL 6.1) **No-** Normal operation

RTP 1.3 LCD Screen Display Not Shown.

Use this RTP when the LCD Display does not illuminate or does not display images.

1. Unplug the machine and plug it back in after 20 seconds
The Operator Interface illuminates.
Yes- Normal operation **No-** Go to Step 2

2. Do ARP 1.6 to remove the Rear Cover.

3. Plug in the AC Power Cord and turn on the Power Switch.

WARNING

Do not perform Repair activities with the power on or electrical power supplied to the machine. Some machine components contain dangerous electrical voltages that can result in electrical shock and possible serious injury.

4. Check the LEDs on the Control Board. The LEDs are labeled, and all are located near the center of the control board.
 - LED3: 24V
 - LED5: 3.3V
 - LED1: 5V

The LEDs are lit.

Yes- Go to Step 5 **No-** Do RTP 1.2 No DC Power.

5. Check that LCD Cable 7724421 is connected at Connector J36 on the Control Board (Section 7 Wiring).

Cable 7724421 is connected at Connector J36.

Yes- Go to Step 6 **No-** Connect Cable 7724421

6. Check that LCD Cable 7724421 is connected at the adapter PCB on the top cover assembly. Do the following to access the LCD cable.
 - a. Open the front door.
 - b. Check if 7724421 cable (large flat ribbon cable) is connected at the LCD adapter PCB.
 - c. If necessary, remove the top cover to better access the LCD display assembly.

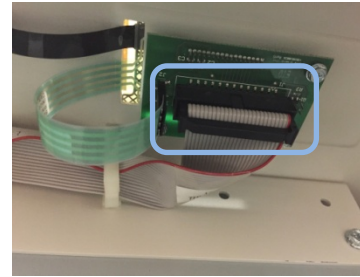

Cable 7724421 is connected at the adapter PCB.

Yes- Go to Step 7 **No-** Connect Cable 7715523. Power cycle the punch to confirm the fault is cleared.

7. Check if the Adapter Ribbon Cable 7724422 is connected at the Adapter PCB and the LCD display.

LCD Cable 7724422 is connected.

Yes- Go to Step 8

No- Connect the Adapter Ribbon Cable 7724422. Unplug and plug in the machine to confirm if the fault is cleared.

8. Inspect the LCD display 7723665.

LCD Display looks OK

Yes- Go to Step 9 **No-** Replace LCD display 7723665

9. Replace the Adapter Ribbon Cable 7724422 and LCD Ribbon Cable 7724421. Power cycle the punch.

This resolves the issue

Yes- Normal Operation **No-** Go to Step 10.

10. Replace the LCD display 7723665 and adapter PCB 7723646. Power cycle the punch.

This resolves the issue

Yes- Normal Operation **No-** Go to Step 11.

11. Replace the main control PCB 7723460

This resolves the issue

Yes- Normal Operation **No-** Escalate to next level

2 PAPER JAMS

This section describes paper jams based on the position of the lead edge/ trail edge of the first jammed sheet.

RTP 2.1 Jam Type A

Do the following if the lead edge stopped by nip N1.

1. Check to see if there is any obstruction to paper flow at the entrance of the machine

Do RTP 2.8 Checking Obstruction in Paper Path - Area 1 (Entrance)

This clears the fault

Yes- Return to normal operation; **No-** Go to Step 2

2. Do RTP 3.1 to check Sensors S21 and S25.

This clears the fault

Yes- Return to normal operation; **No-** Go to Step 3

3. Do RTP 5.1 *Checking Stepper Motors* to check Bypass Motor M8.

This clears the fault

Yes- Return to normal operation; **No-** Go to Step 4

4. Do *GP 6.14 Idler Roller Inspection and Cleaning* and *GP 6.15 Drive Roller Inspection and Cleaning*, to inspect and clean the rollers in Nip N1 (PL 2.6).

This clears the fault

Yes- Return to normal operation; **No-** Escalate to next level

RTP 2.2 Jam Type B

Do the following if the lead edge is stopped past nip N1 to lead edge is stopped just before nip N5.

1. Check to see if there is any obstruction in the paper path from nip N1 to nip N5

Do RTP 2.8 Checking Obstruction in Paper Path - Area 2 (Entrance Idler Panel Assembly).

This clears the fault

Yes- Return to normal operation; **No-** Go to Step 2

2. Check Sensors S1,S2, S3,S4,S5,S18,S19,S20,S21, and S25
 - Do RTP 3.1 *Check Sensors S1, S2, S3, S4, S5, S22, S23, S24, S25, S26* and
 - Do RTP 3.2 Check Sensors S6 to S21.

This clears the fault

Yes- Return to normal operation; **No-** Go to Step 3

3. Do RTP 5.1, Checking Stepper Motors to check Motor M1 and Motor M8.

This clears the fault

Yes- Return to normal operation; **No-** Go to Step 4

4. Do RTP 4.3 Check Solenoids SOL 3 to SOL 8 to 8 to check solenoids SOL3 and SOL 4.

This clears the fault

Yes- Return to normal operation; **No-** Go to Step 5

5. Check the diverter mechanism- Do RTP 4.1 Check Solenoid SOL 1.

This clears the fault

Yes- Return to normal operation; **No-** Go to Step 6

6. Check the nip force of rollers N2, N3, N4. This can be done by:
 - Do GP 6.14 *Idler Roller Inspection and Cleaning* to inspect the idler roller springs for these rollers.
 - Do GP 6.15 *Drive Roller Inspection and Cleaning* to check the Drive Roller condition. Clean if necessary.

- Check the Paper path drive panel positions- see ADJ 1.8, Drive Panel Position Adjustment and perform adjustments if necessary.
- Check the Entrance Idler Panel position (PL 2.1)- see ADJ 1.7 Idler Panel Magnetic Latches Adjustment, perform adjustment as necessary.

This clears the fault

Yes- Return to normal operation; **No-** Escalate to next level

RTP 2.3 Jam Type C

Do the following if the lead edge is stopped past nip N5 to lead edge is stopped just before Steering rollers N6 and N7.

1. Check to see if there is any obstruction in the paper path.

Do RTP 2.8 Checking Obstruction in Paper Path – Area 3 (Acceleration Roller Idler)

This clears the fault

Yes- Return to normal operation; **No-** Go to Step 2

2. Check Sensors S1, S2, S3, S4, S5, S11, S12, S13, S14, S15, S16, S17, S18, S19, S20, S21, and S25.

- Do RTP 3.1 *Check Sensors S1, S2, S3, S4, S5, S22, S23, S24, S25, S26* and
- Do RTP 3.2 *Check Sensors S6 to S21*

This clears the fault

Yes- Return to normal operation; **No-** Go to Step 3

3. Do RTP 4.3 Check Solenoids SOL 3 to SOL 8 to check solenoids SOL3, SOL4 and SOL 5.

This clears the fault

Yes- Return to normal operation; **No-** Go to Step 4

4. Do RTP 5.1 Checking Stepper motors to check motors M1 and M2.

This clears the fault

Yes- Return to normal operation; **No-** Go to Step 5

5. Remove the Die Set and inspect the die throat. Make sure there is nothing restricting the flow of paper.

This clears the fault

Yes- Return to normal operation; **No-** Go to Step 6

6. Do RTP 2.8 Checking Obstruction in Paper Path – Area 4 (Punch Module).

This clears the fault

Yes- Return to normal operation; **No-** Go to Step 7

7. If the sheet is stopped by a die pin protruding through the die throat, do ADJ 1.5 to perform Punch Clutch Indexing.

This clears the fault

Yes- Return to normal operation; **No-** Go to Step 8

8. When a sheet is jammed with the lead edge (or one of the corners in the lead edge) at a location where the die pins are, do the following:

- Open the front door.
- Look through the gap along the exit side of the die set. You will not be able to see the lead edge of the sheet. (One of the corners may be jammed in the die pin area, and the other corner may have advanced through the paper path).

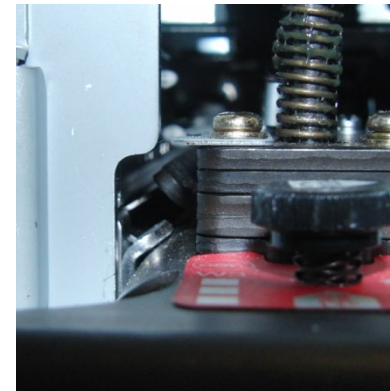

Unlock the die and look through the entrance side of the die set, you will be able to see the sheet.

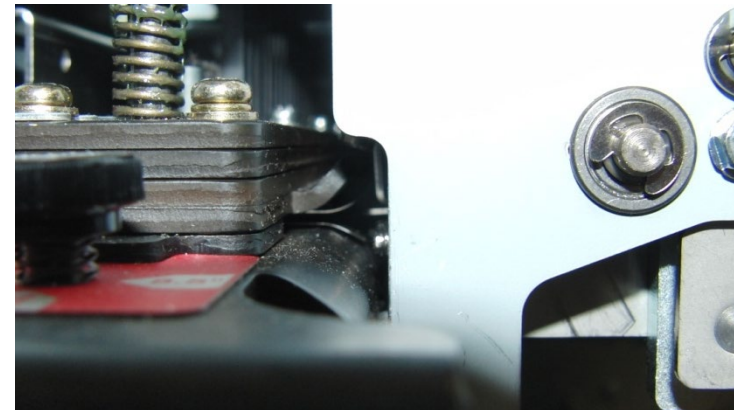

- Unlatch the acceleration idler panel and Entrance Idler panel to see the trail edge of the sheet. (the trail edge of the sheet will be skewed if one of the corners is jammed as opposed to the whole lead edge being jammed)



This clears the fault

Yes- Return to normal operation; **No-** Go to Step 9

This clears the fault

Yes- Return to normal operation; **No-** Escalate to next level

9. If there are multiple sheets jammed with the die pins partially through the sheet(s), do RTP 2.7 Multiple Sheets Jammed - Die Pins Partially Through the Sheets.

This clears the fault

Yes- Return to normal operation; **No-** Go to Step 10

10. Check the nip force of roller N5

- Do *GP 6.16 Panel Latch Inspection* to inspect the Acceleration Idler Panel Latch. If the Acceleration Idler Panel is not closed firmly, there will be insufficient nip force at N5.
- Do *GP 6.14 Idler Roller Inspection and Cleaning* to inspect the idler roller springs for these rollers Inspect Idler Roller Spring
- Do *GP 6.15 Drive Roller Inspection and Cleaning* to check the Drive Roller condition. Clean if necessary.
- Check the Paper Path Drive Panel positions- see *ADJ 1.8, Drive Panel Position Adjustment* and perform adjustments if necessary.

RTP 2.4 Jam Type D

Do the following if the lead edge of the first jammed sheet is past N6 and N7 but its trail edge is before or just past N6/N7

1. Check to see if there is any obstruction in the paper path.

This clears the fault

Yes- Return to normal operation; **No-** Go to Step 2

2. Do RTP 3.1 to check Sensors S3, S4, S5, S22, S23, S24, and S25.

This clears the fault

Yes- Return to normal operation; **No-** Go to Step 3

3. Do RTP 3.2 to check Sensors S6, S7, S8, S9, S10, S11, S12, S13, S14, S15, S16, S17, and S22.

This clears the fault

Yes- Return to normal operation; **No-** Go to Step 4

4. Do RTP 3.3 to check Sensor S28.

This clears the fault

Yes- Return to normal operation; **No-** Go to Step 5

5. Do RTP 4.3 to check Solenoids SOL3 to SOL8.

This clears the fault

Yes- Return to normal operation; **No-** Go to Step 6

6. Do RTP 5.1 to check Motors M1, M2, M3, M4, M5, M6 and M7.

This clears the fault

Yes- Return to normal operation; **No-** Go to Step 7

7. Do RTP 2.8 Checking Obstruction in Paper Path - Area 4 Punch Module.

This clears the fault

Yes- Return to normal operation; **No-** Go to Step 8

8. Do GP 6.15 Drive Roller and Steering Drive Roller Inspection and Cleaning, to Inspect and Clean Steering Drive Rollers

This clears the fault

Yes- Return to normal operation; **No-** Go to Step 9

9. Do GP 6.14.2 Steering Idler Roller and Springs Inspection and Cleaning.

This clears the fault

Yes- Return to normal operation; **No-** Go to Step 10

10. Inspect Punch Clutch Anti-Rotation Screw (M6 socket head screw) of the Punch clutch. If it is loose, tighten it. See ARP 3.7 for details.

This clears the fault

Yes- Return to normal operation; **No-** Go to Step 11

11. Check the (2x) Cone Point Set Screws of the Punch Clutch. Tighten if loose, Replace with new ones if missing. See ARP 3.7 for details.

This clears the fault

Yes- Return to normal operation; **No-** Go to Step 12

12. Do GP 6.23 Alignment Carriage Rails Cleaning.

This clears the fault

Yes- Return to normal operation; **No-** Go to Step 13

13. Inspect the ground strap in the Alignment Carriage Sub Assembly (PL 4.3). If continuity is missing, fasten it with the appropriate screw. If it is cut/damaged, replace the ground strap (PL 4.4).

This clears the fault

Yes- Return to normal operation; **No-** Go to Step 14

14. Check if the machine is docked properly- GP 6.4

This clears the fault

Yes- Return to normal operation; **No-** Go to Step 15

15. Inspect the Lower Exit Panel's magnetic latch, See ADJ 1.7 Idler Panel Magnetic Latches Adjustment.

If the fault still exists, escalate to next level.

RTP 2.5 Jam Type E

Do the following if the first jammed sheet's trail edge is past N6 and N7

1. Check to see if there is any obstruction in the paper path from N8 to N11.

Do RTP 2.8 *Checking Obstruction in Paper Path*.

This clears the fault

Yes- Return to normal operation; **No-** Go to Step 2

2. Do RTP 3.1 to check Sensors S3, S4, S5, S22, S23, S24, and S25.

This clears the fault

Yes- Return to normal operation; **No-** Go to Step 3

3. Do RTP 3.2 to check Sensors S6, S7, S8, S9, S10, S11, S12, S13, S14, S15, S16, S17, S18, S19, S20, and S21.

This clears the fault

Yes- Return to normal operation; **No-** Go to Step 4

4. Do RTP 3.3 to check Sensor S28.

This clears the fault

Yes- Return to normal operation; **No-** Go to Step 5

5. Do RTP 4.3 to check Solenoids SOL3 to SOL8.

This clears the fault

Yes- Return to normal operation; **No-** Go to Step 6

6. Do RTP 5.1 to check Motors M6, M7, and M8.

This clears the fault

Yes- Return to normal operation; **No-** Go to Step 7

7. Check the nip forces of roller N8, N9, and N10. This can be done by:
(same as Jam type B)

- Do GP 6.14 *Idler Roller Inspection and Cleaning* to inspect the idler roller springs for these rollers
- Do GP 6.15 *Drive Roller Inspection and Cleaning* to check the Drive Roller condition. Clean if necessary.

- Check the Paper path drive panel positions - do ADJ 1.8 *Drive Panel Position Adjustment* and perform adjustments if necessary.
- Check the Exit Idler Panel position - See ADJ 1.7 *Idler Panel Magnetic Latches Adjustment*. Perform adjustment if necessary

This clears the fault

Yes- Return to normal operation; **No-** Escalate to next level

RTP 2.6 Jam Type F

Do the following if there is any obstruction in the paper path in the bypass section.

1. Check if there is any obstruction in the paper path in the bypass section.

Do RTP 2.1 *Jam Type A*.

This clears the fault

Yes- Return to normal operation; **No-** Go to Step 2

2. Do RTP 3.1 *Check Sensors S1, S2, S3, S4, S5, S22, S23, S24, S25, S26*.

This clears the fault

Yes- Return to normal operation; **No-** Go to Step 3

3. Do RTP 5.1 *Checking Stepper Motors* to check Bypass Motor M8 (PL 2.6).

This clears the fault

Yes- Return to normal operation; **No-** Go to Step 4

4. Check the Diverter mechanism, do RTP 4.1.

This clears the fault

Yes- Return to normal operation; **No-** Go to Step 5

5. Check the nip force of rollers N1, N11, N12, N13 and N14. This can be done by:

- Do GP 6.14 *Idler Roller Inspection and Cleaning* to inspect the idler roller springs for these rollers
- Do GP 6.15 *Drive Roller Inspection and Cleaning* to check the Drive Roller condition. Clean if necessary.
- Check the Paper path drive panel positions- see ADJ 1.8, and perform adjustments if necessary.
- Check the Exit Idler Panel position- see ADJ #1.7 *Idler panel Magnetic Latches* adjustments, perform adjustment if necessary.

This clears the fault

Yes- Return to normal operation; **No-** Escalate to second level

RTP 2.7 Multiple Sheets Jammed - Die Pins Partially Through the Sheets

Use this RTP if there are multiple sheets jammed with the die pins partially through the sheets.

1. Crank the punch shaft in the clock-wise CW direction (when viewed from the front of the machine) using the flats in the front of the machine.

Flats are also present in the back side of the shaft which can be accessed by removing the rear cover. (rotate counter clock wise CCW when viewed from the back side)

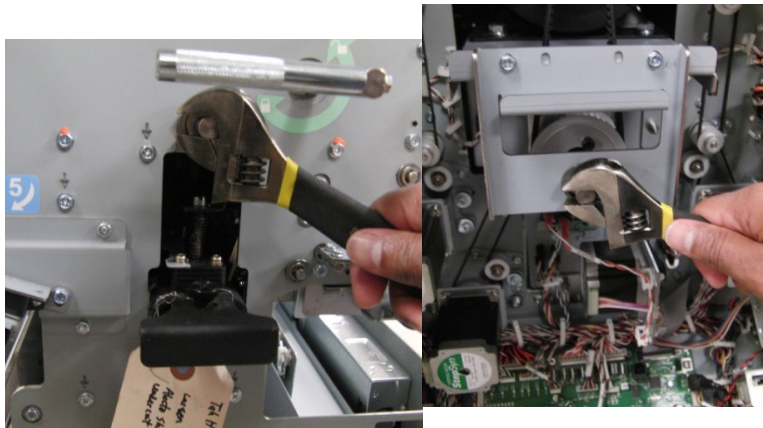

2. Remove the jammed sheets.
3. If it is too difficult to crank the punch shaft:
 - Remove rear cover.
 - Disconnect the clutch wires at the Clutch Solenoid

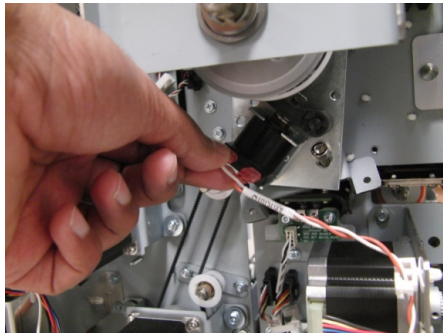

- Remove two screws that hold the Punch Clutch Bracket

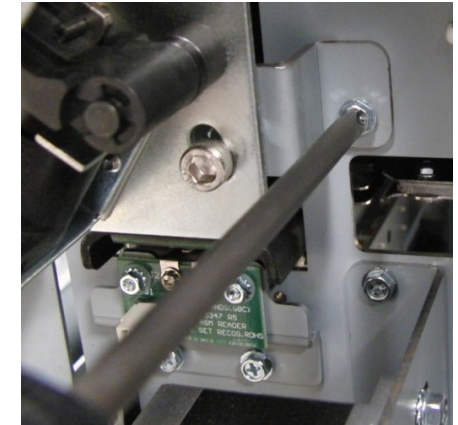

- Rotate the Clutch along with the shaft in the opposite direction (clockwise CW direction when viewed from the back) until the pins exit the sheet.

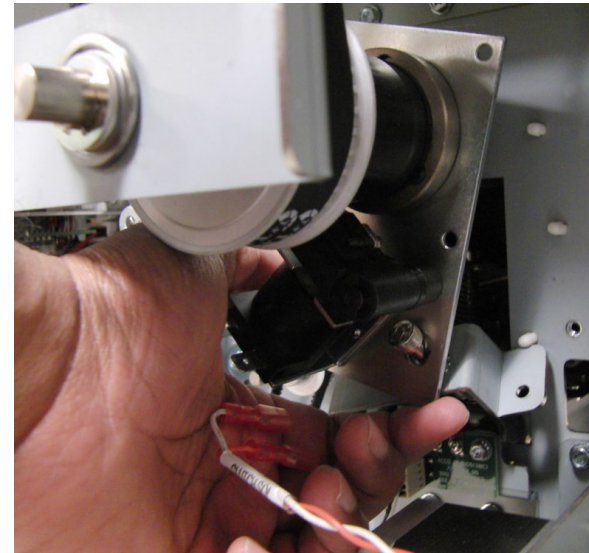

- Remove the jammed sheets.
- Return the Clutch Bracket and the Clutch to their positions and install the Screws.
- Connect the clutch wires at the Clutch Solenoid In the Function mode of the LCD screen, run *Cycle Punch* to verify the punch cam returns to home position. If it does not, do ADJ 1.5 to perform *Punch Clutch Indexing*.

RTP 2.8 Checking Obstruction in Paper Path

Use this RTP to checking for an obstruction in the paper path.

When inspecting for obstruction to paper path, look for any ripped pieces of paper or any other objects like loose fasteners along the paper path. A few key areas to inspect are shown below:

Area 1 (Entrance)

1. Open the Front Door.
2. Open the Bypass Panel.
3. Inspect the gap between the Drive Roller and the sheet metal panel for any objects.

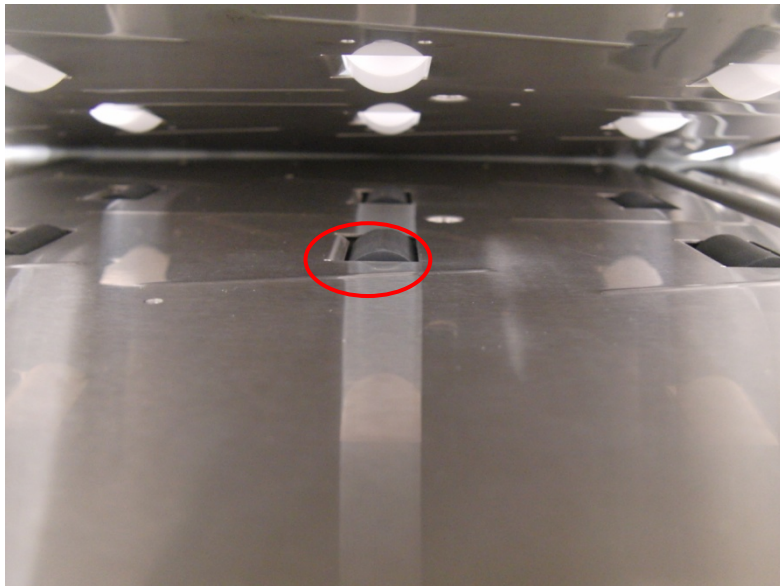

Area 2 (Entrance Idler Panel Assembly)

1. At the top of Area 2 (Entrance Idler Panel Assembly), check if there is a 2 to 3mm gap for sheet flow.

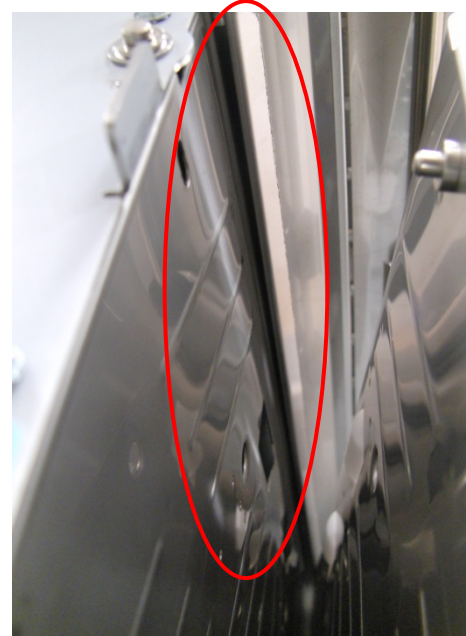

2. If the Lower entrance panel (PL #) is bent, Replace it (ARP #); If the Inner Entrance panel (PL #) is bent, Replace it (ARP #).

Area 3 (Acceleration Roller Idler)

1. Inspect for any object wedged between the roller and sheet metal window.



Area 4 (Punch Module)

1. Remove the Die Set and inspect at the following locations.
2. Check the Guide Brackets immediately upstream and downstream of the Die Set.

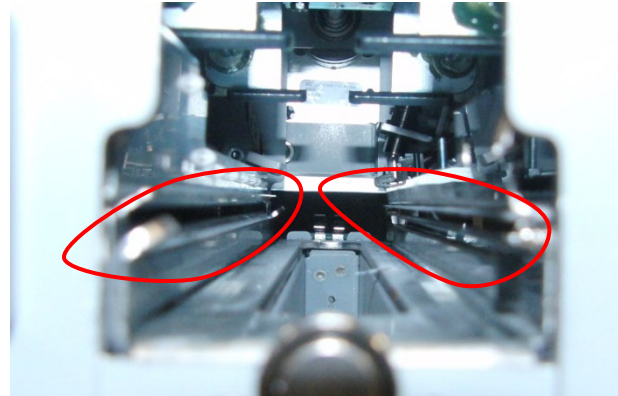

3. Remove the M4 Nuts (3) and the cover for Area 5.

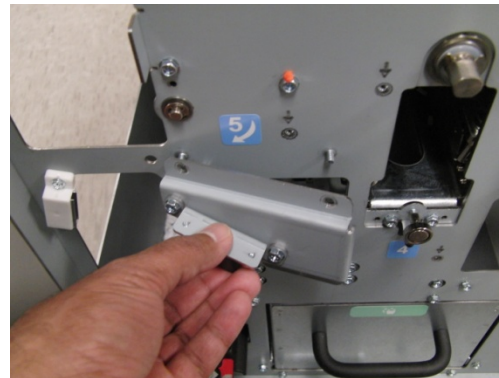

4. Inspect the paper path for any obstructions closely.
(Cont.)

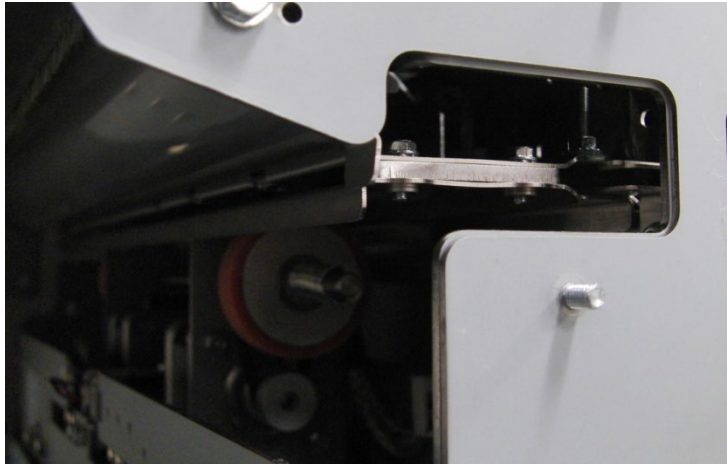

5. Check that the Steering Drive (Drive Panel Steering Sub Assembly) and the Idler Panels should be centered to the guide brackets as shown.

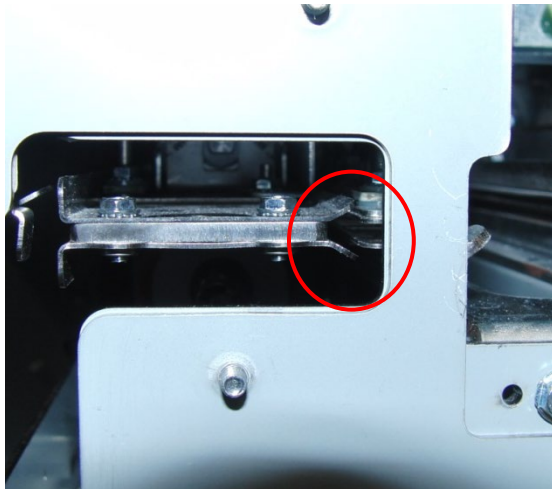

6. If one of the below panels is bent, Replace
 - Steering idler panel weldment- PL 4.4; ARP 3.15
 - Steering drive panel weldment- PL 4.5; ARP 3.17
 - Alignment sensor bracket- PL 4.10; ARP 3.24
 - Alignment sensor lower guide- PL 4.10; ARP 3.24

RTP 2.9 Crease or Perf Die Stuck in Down Position

Use this RTP if the Crease or Perf Die is jammed in a down position. This means that the punch module became stuck before the springs of the die were fully compressed.

1. Crank the punch shaft in the clock-wise CW direction (when viewed from the front of the machine) using the flats in the front of the machine.

Flats are also present in the back side of the shaft which can be accessed by removing the rear cover. (rotate counter clock wise CCW when viewed from the back side)

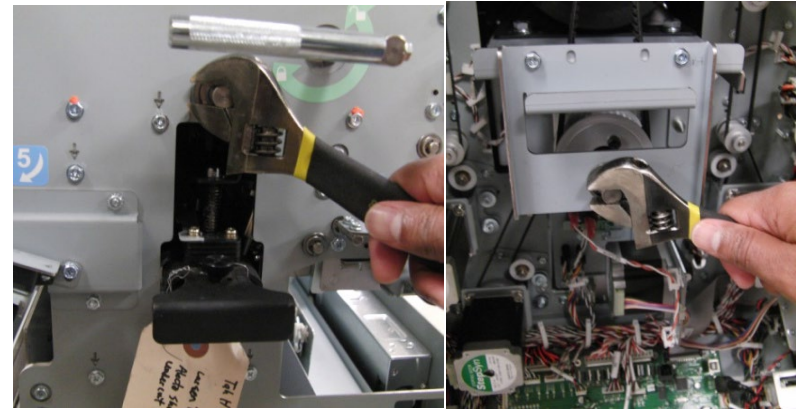

2. If the jam does not re-occur, continue normal operation. If jams occur repeatedly, inspect the die. Ensure that the die can move up and down smoothly without requiring excessive force.
3. Re-lubricate the die shoulder bolts with grease (not oil)
 - a. [add picture]
4. If a Perf die is typically used, replace the perf die backing plate with a new backing plate.
5. If this does not solve the issue, inspect the punch cams and wear plates. If wear plates are extremely worn, replace the wear plates.
6. Re-lubricate the punch cams and wear plates with a thin layer of high quality grease (not oil)

3 SENSOR CHECKS

RTP 3.1 Check Sensors S1, S2, S3, S4, S5, S22, S23, S24, S25, S26

Use this RTP to check sensors S1, S2, S3, S4, S5, S22, S23, S24, S25, S26.

1. Do GP 6.2.4 *SENSORS Procedure*. Check to make sure all sensors should show “0” on the LCD when uncovered and “1” when covered. If any sensor shows “1” when uncovered, clean that sensor. Also check is there us any obstacle in the sensor window.

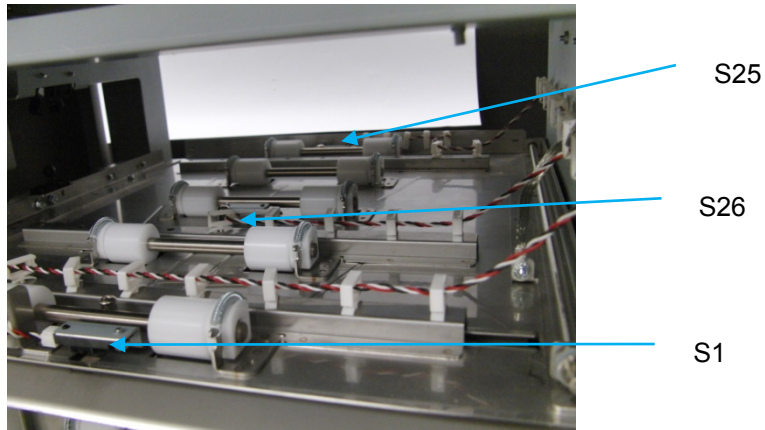

Sensors S1, S25, and S26 are on the Upper Bypass Panel (PL 3.5).

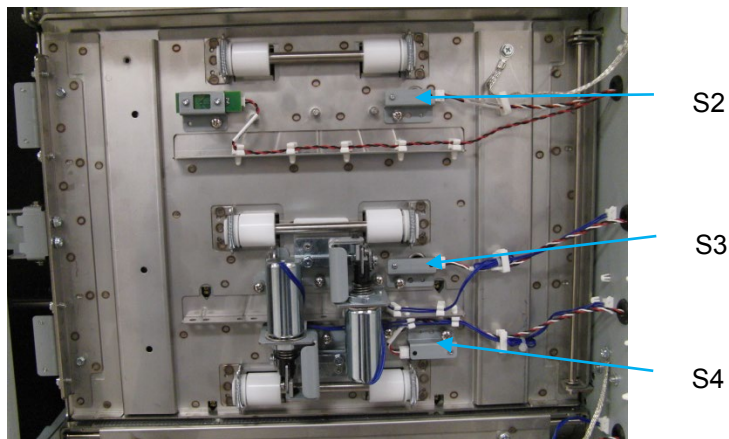

Sensors S2, S3, and S4 are on the Entrance Idler Panel (PL 3.2).

Sensor S5 is on the Acceleration Roller Idler (PL 3.3)

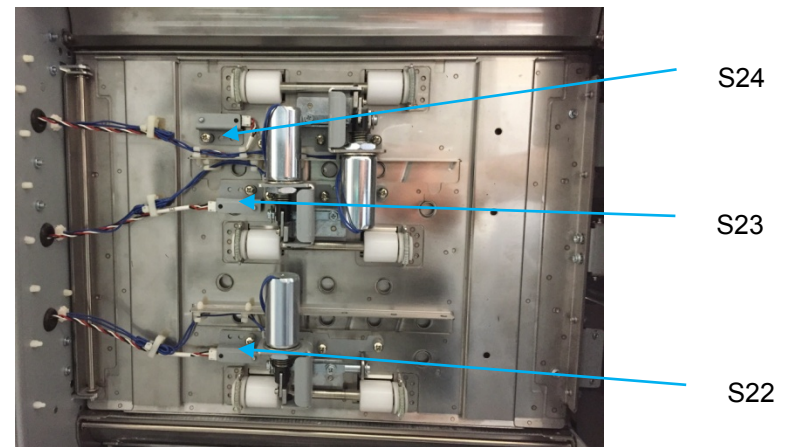
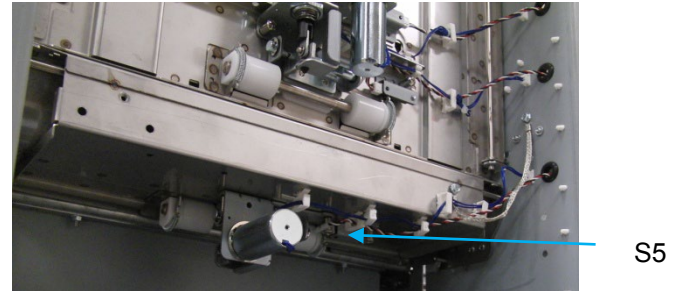

All sensors show “0” when uncovered and “1” when covered
Yes- Return to the RTP that directed you here.
No- Go to Step 2

5. Make sure the sensor wire is connected securely at the Sensor and at the Main Control Board. Do ARP 1.6 to remove the Rear Cover to gain access to the connector at the Control Board.

See the *Sensor Cables* table on page 2-33 for cable numbers.
See Section 7 Wiring for details on connection at the sensor(s)

All the connections are made securely

Yes- Go to Step 3

No- Make the connection and return to normal operation.

11. Replace the Sensor with a new one (alternatively, swap the sensor in the faulty position with a sensor from a different good position to check if it is a bad sensor). See ARP 2.25 for Sensor Replacement.

Replacing the sensor corrects the issue

Yes- Use the new sensor and return to normal operation

No- Go to Step 4

12. Do GP 6.3 to Undock the STREAMPUNCH VF and visually inspect the Cable from the sensor all the way to the Control Board (PL 6.1). If the Cable is damaged, replace the Cable.

See the *Sensor Cables* table on page 2-33 for cable numbers.

Sensor cable looks okay

Yes- Go to Step 5

No- Go to Step 6

13. Do GP 6.2.12 FIRMWARE UPGRADE Procedure to Re-flash the firmware for the STREAMPUNCH VF.

Re-flashing firmware clears the fault

Yes- Resume normal operation; **No-** Go to Step 6

14. Replace the Sensor Cable.

- Do GP 6.3 to Undock the STREAMPUNCH VF.
- Remove the faulty cable from the sensor by releasing the required cable clamps.
- Replace with a new cable.

See the *Sensor Cables* table on page 2-33 for cable numbers.

Replacing the sensor cable corrects the issue

Yes- Resume normal operation; **No-** Go to Step 7

15. Do ARP 5.1 to Replace the Main Control Board (PL 6.1).

This clears the fault

Yes- Resume normal operation; **No-** Escalate to second level

Sensor
Cables

Sensor	Description	Cable #	Header	Interim Cable #	Control Board Connector	
S1	Entrance Sensor, S1	7715451	-	-	J21	Shares cable with S25, S26
S2	Entrance Sensor, Top	7715453	-	-	J22	Shares cable S2, S3, S4, S5
S3	Entrance Sensor, Middle	7715453	-	-	J22	Shares cable S2, S3, S4, S5
S4	Entrance Sensor, Bottom	7715453	-	-	J22	Shares cable S2, S3, S4, S5
S5	Accel Sensor	7715453	-	-	J22	Shares cable S2, S3, S4, S5
S6	Skew Sensor Board	7715508	Header	7715455	J23	
S7	Skew Sensor Board	7715508	Header	7715455	J23	
S8	Skew Sensor Board	7715508	Header	7715455	J23	
S9	Skew Sensor Board	7715508	Header	7715455	J23	
S10	Skew Sensor Board	7715508	Header	7715455	J23	
S11	Alignment Sensor Board	7715509	Header	7715456	J24	
S12	Alignment Sensor Board	7715509	Header	7715456	J24	
S13	Alignment Sensor Board	7715509	Header	7715456	J24	
S14	Alignment Sensor Board	7715509	Header	7715456	J24	
S15	Alignment Sensor Board	7715509	Header	7715456	J24	
S16	Trail Edge BG Sensor Board	7715510	Header	7715457	J25	Shares cable with S28
S17	Trail Edge BG Sensor Board	7715510	Header	7715457	J25	Shares cable with S28
S18	Large Mid Punch Sensor Bd	7715458	-	-	J26	Shares cable with S20/S21
S19	Large Mid Punch Sensor Bd	7715458	-	-	J26	Shares cable with S20/S21
S20	X-Large Mid Punch Sensor Bd	7715458	-	-	J26	Shares cable with S18/S19
S21	X-Large Mid Punch Sensor Bd	7715458	-	-	J26	Shares cable with S18/S19
S22	Exit Sensor, Bottom	7715459	-	-	J28	
S23	Exit Sensor, Middle	7715459	-	-	J28	
S24	Exit Sensor, Top	7715459	-	-	J28	
S25	Exit Sensor	7715451	-	-	J21	Shares cable with S1, S26
S26	Bypass Sensor, Middle	7715451	-	-	J21	Shares cable with S1, S25
S28	Align Home Sensor	7715519	Header	7715457	J25	Shares cable with S16/S17
S29	Chip Level Sensor - Emitter/Receiver	7715485	-	-	J27	
S1B	Clear Cover Sensor – Emitter/Receiver	7715536	-	-	J29	

RTP 3.2 Check Sensors S6 to S21

Use this RTP to check Sensors S6 to S21.

Sensors S6, S7, S8, S9, S10

To Access Sensors S6, S7, S8, S9, S10

- Undock STREAMPUNCH VF- This step is optional- if possible reach in through the jam access opening without undocking the punch.
- Open Front Door.
- Open Lower Exit Panel Assembly.

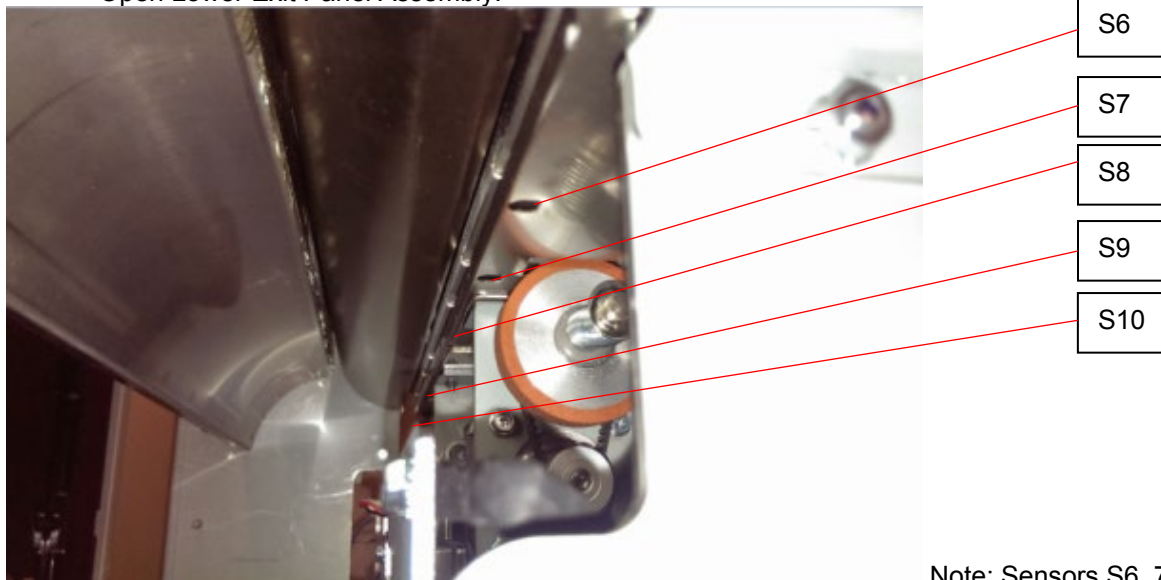

Note: Sensors S6, 7, 8, 9 and 10 are on the Skew Sensor Board

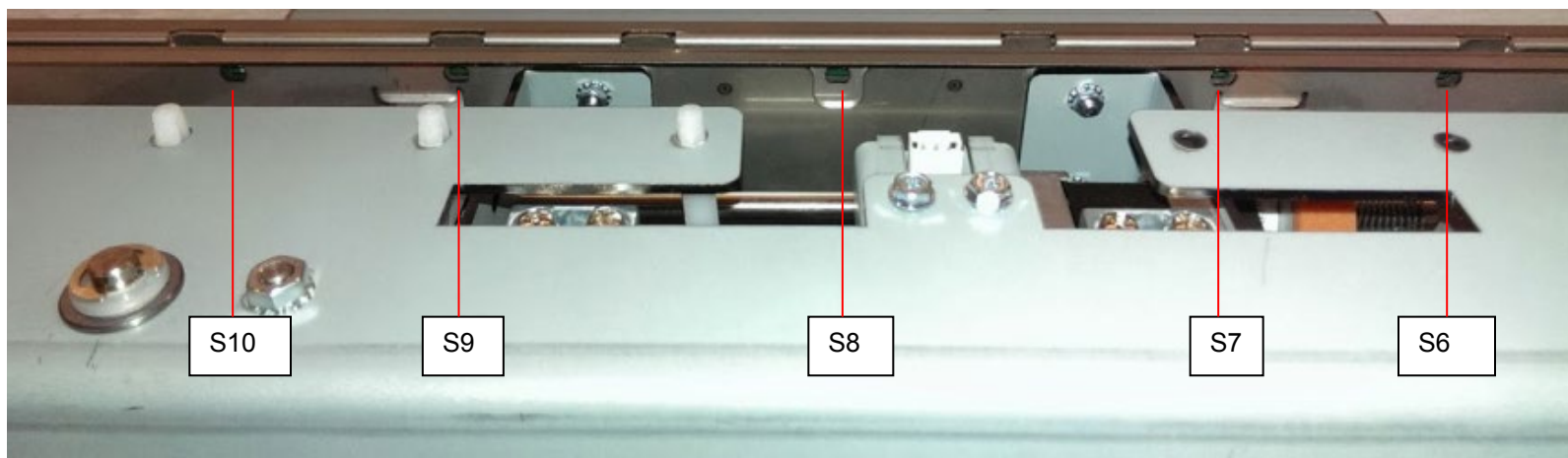

Sensors S11, S12, S13, S14 and S15

To Access Sensors S11, S12, S13, S14 and S15

- Undock STREAMPUNCH VF- This step is optional- if possible reach in through the jam access opening without undocking the punch.
- Locate the Alignment Sensor Board

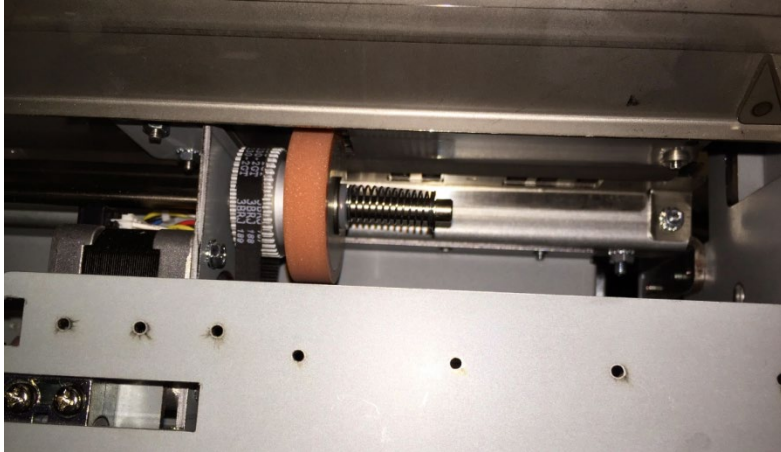

Sensors S11, 12, 13, 14 and 15 are on the Alignment Sensor Board

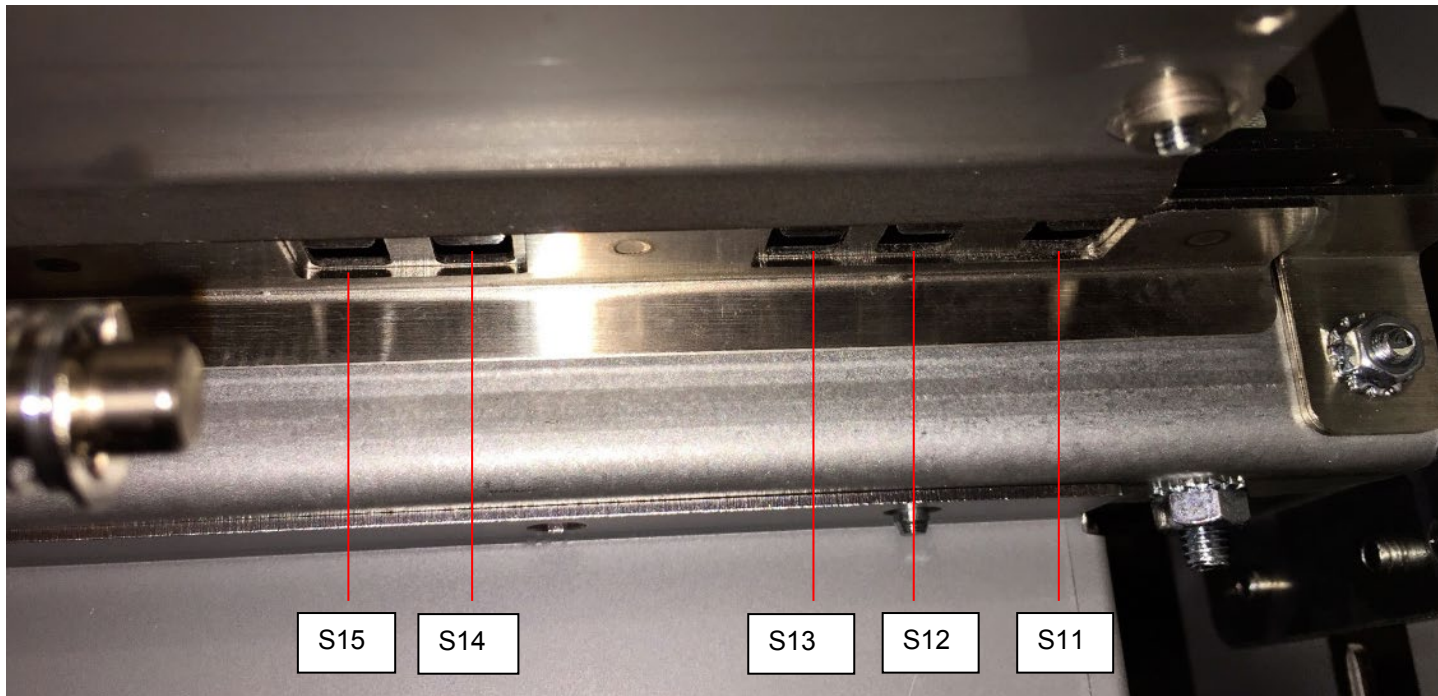

Sensors S16 and S17

To Access Sensors S16 and S17:

- Open the Front Door.
- Unlatch and open the Acceleration Idler Panel.

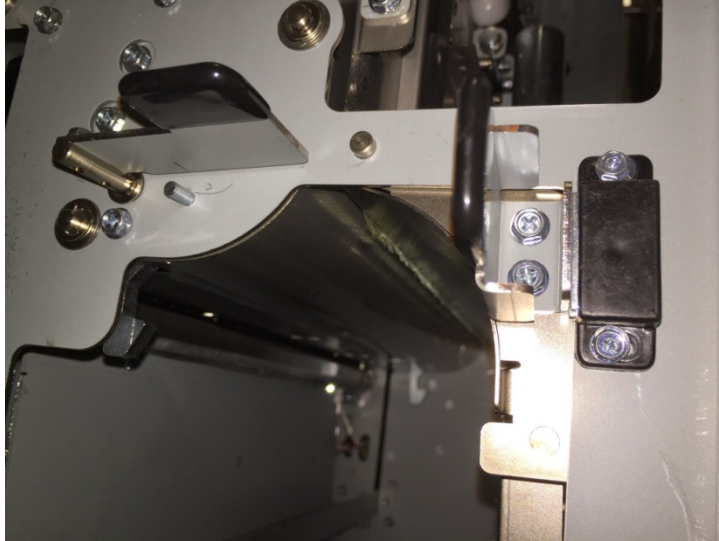

Sensors S16 and S17 are on Backgage Sensor Board.



S16

S17

Sensors S18, S19, S20 and S21

To Access Sensors S18, S19, S20 and S21:

- Open the Front Door.
- Unlatch and open the Entrance Idler Panel.

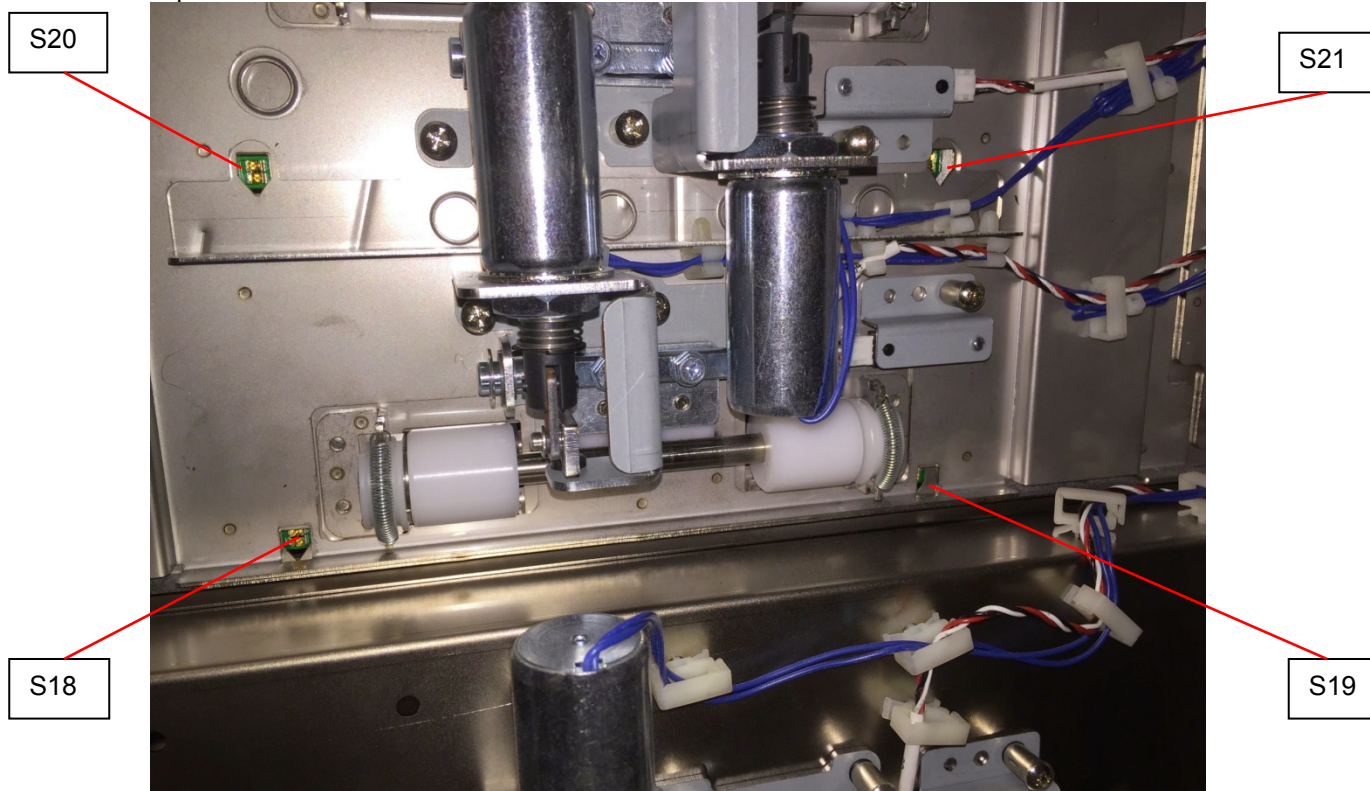

Sensors S18 and S19 are on Mid Punch Large Backgage Sensor Board.

Sensors S20 and S21 are on Mid Punch XL Backgage Sensor Board.

Procedure

1. Do GP 6.2.5 *SENSORS Procedure*. Check to make sure all sensors should show “0” on the LCD when uncovered and “1” when covered. If any sensor shows “1” when uncovered, clean that sensor. Also check if there is any obstacle in the sensor window.

All sensors show “0” when uncovered and “1” when covered

Yes- Return to the RTP that directed you here.

No- Go to Step 2

2. Check the connections to the faulty sensor(s).

See the *Sensor Cables* table on page 2-33 for cable numbers.

- Remove Rear cover- ARP 1.6. Check the connection at the header in the Punch frame and the Main Control Board. See Section 7 Wiring for the location of the Connector.
- Remove the Punch module- ARP 3.1.1. Check the connection from the sensor board to the header in the punch frame. S18 to 21 do not have headers, so inspect the connection at Sensor Board and Main Control Board (PL 6.1).

All the connections are made securely

Yes- Go to Step 3

No- Make the connection and return to normal operation.

3. Light from sensor components can be viewed with a cell phone camera, if the sensor is working you will be able to see a bright light. Alternately a small mirror can be used.

CAUTION: Sensor emits High Intensity narrow angle Infrared beam (940nm). It is invisible to naked eye, avoid looking directly at the sensor when the machine is powered ON.

- a) If there is no light from any sensor on that particular board (S6-S10; S11-S15; S16-17; S18-19; S20-21),
- Replace cable. Replace the Cable from the Sensor Board to the Punch Frame first. If that does not solve the issue, Replace cable from frame to Main Control Board. See the *Sensor Cables* table on page 2-33 for cable numbers.
 - Replace the faulty Sensor Board (ARP 2.25)
- b) On the same board- If there is light from one sensor and there is no light from another sensor:
- Replace the faulty Sensor Board (ARP 2.25).

- Replace Sensor Cable. Replace the Sensor Cable from the Sensor Board to Punch Frame first. If that does not solve the issue, Replace the Sensor Cable from the frame to Main Control Board. See the *Sensor Cables* table on page 2-33 for cable numbers.

There is a bright light from all the sensors

Yes- Go to Step 4;

No- Replace the faulty component and resume normal operation

4. Replace the faulty sensor board- ARP 2.25

This clears the fault

Yes- Resume normal operation

No- Go to Step 5

5. Replace the faulty sensor cable

See the *Sensor Cables* table on page 2-33 for cable numbers.

This clears the fault

Yes- Resume normal operation

No- Go to Step 6

6. Do GP 6.2.12 FIRMWARE UPGRADE Procedure to Re-flash the firmware for the STREAMPUNCH VF.

This clears the fault

Yes- Resume normal operation

No- Go to Step 7

7. Do ARP 5.1 to Replace the Main Control Board

This clears the fault

Yes- Resume normal operation

No- Escalate to second level

RTP 3.3 Checking Sensor S28 Align Home Sensor

Location

To Access Sensor S28:

- Open the Front Door.
- To uncover this sensor, slide the Alignment carriage towards the front of the machine.
- To cover this sensor, slide the Alignment carriage towards the rear of the machine.

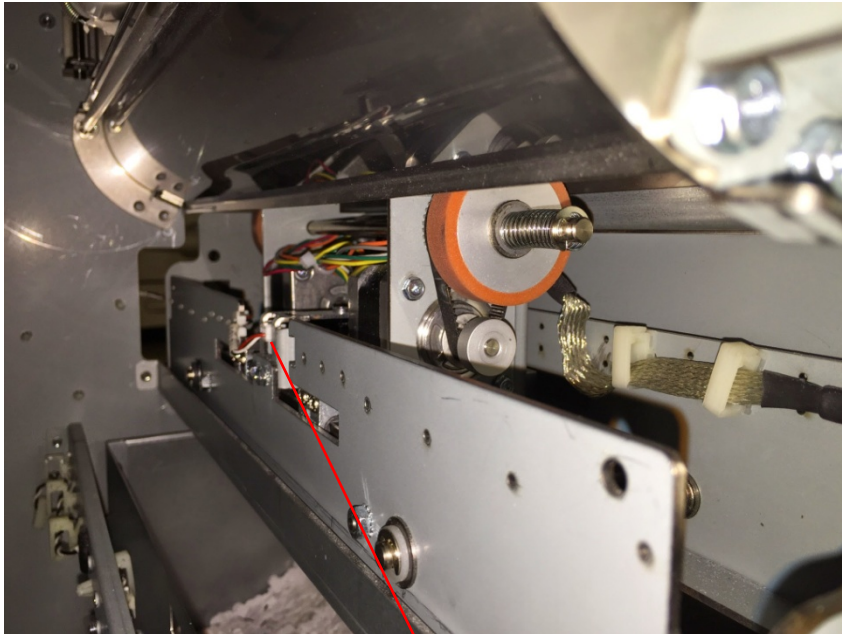

S28

Procedure

1. Do GP 6.2.5 SENSORS Procedure. Check to make sure the sensor shows “1” on the LCD when the Alignment carriage flag blocks the sensor and “0” when the Alignment carriage flag unblocks the sensor.
LCD shows “0” when unblocked and “1” when blocked
Yes- Return to the RTP that directed you here.
No- Go to Step 2
2. Make sure the sensor wire is connected securely at the header in the punch module frame and the main control board
See the *Sensor Cables* table on page 2-33 for cable numbers.
See Section 7 Wiring for the location of the Connector.
Connection is secure at the punch frame and Control board.
Yes- Go to Step 3;
No- Make the connection and resume normal operation
3. With the front door open, check if the sensor wire is connected securely at the sensor and the punch module frame on the inside.
Connection is secure at both ends
Yes- Go to Step 4;
No- Make the connection and resume normal operation
4. Replace the Align Home Sensor ARP 2.25.4
This clears the fault
Yes- Resume normal operation; **No-** Go to Step 5
5. Visually inspect the Sensor cable 7715519 from Sensor to Punch frame header; 7715457 Punch frame header to Control board. If the cable is damaged, replace the cable. To closely inspect the sensor cable from sensor to header, it is recommended to undock the punch.
Cable appears to be damaged
Yes- go to Step 7 or 8; **No-** Go to Step 6
6. Do GP 6.2.12 FIRMWARE UPGRADE Procedure to Re-flash the firmware for the STREAMPUNCH VF.
This clears the fault
Yes- Resume normal operation; **No-** Go to Step 7

7. Replace the Sensor Cable from Align Home Sensor to header; refer to Section 7- Wiring.

This clears the fault

Yes- Resume normal operation; **No-** Go to Step 8

8. Replace the cable from header to Main control board, refer to Section 7- Wiring.

This clears the fault

Yes- Resume normal operation; **No-** Go to Step 9

9. Do ARP 5.1 to Replace the Main Control Board (PL 6.1).

This clears the fault

Yes- Resume normal operation

No- Escalate to second level

4 SOLENOID CHECKS

RTP 4.1 Check Solenoid SOL 1

Solenoid SOL1 is the diverter solenoid- mechanical adjustment is covered in detail in ADJ 1.2 Diverter Solenoid Adjustment.

1. Open the front the door and insert an Interlock Cheater into the Punch Door interlock Switch SW4 (PL 2.8).

WARNING

Moving Parts, keep hands clear of nips and the belts when the Interlock Cheater is inserted.

2. Do GP 6.2.6 *SOLENOIDS Procedure* to activate and deactivate Solenoid SOL1.

The diverter gate should rise and fall when SOL1 is cycled.

Diverter gate rises and falls when SOL1 is cycled

Yes- Return to the RTP that directed you here

No- Go to Step 3 and choose the appropriate condition

3. If SOL1 does not function, do the below steps:
 - Do ARP 1.6 to remove the Rear Cover.
 - Check the cable from the solenoid to the in-line header. This cable is part of the solenoid body.
 - Check the cable 7715466 that connects the in-line header to the Main Control Board.
 - Replace the SOL1 (ARP 2.28.1) or 7715466, as needed.

If SOL1 functions, do the below steps:

- Go to ADJ 1.2 Diverter Solenoid Adjustment and perform adjustment if necessary.

This clears the fault

Yes- Return to normal operation **No-** Go to Step 4

4. Do GP 6.2.12 *FIRMWARE UPGRADE Procedure* to Re-flash the firmware for the STREAMPUNCH VF.

This clears the fault

Yes- Return to normal operation; **No-** Go to Step 5

5. Do *ARP 2.28.1 Diverter Solenoid Replacement*.

This clears the fault

Yes- Return to normal operation; **No-** Go to Step 6

6. Do *ARP 5.1. Main Control Board Replacement*.

This clears the fault

Yes- Return to normal operation; **No-** Escalate to second level

RTP 4.2 Check Solenoid SOL 2

Solenoid SOL 2 is the Punch Clutch, see:

- RTP 2.4 Jam Type D.
- RTP 2.7 Multiple Sheets Jammed - Die Pins Partially Through the Sheets.

RTP 4.3 Check Solenoids SOL 3 to SOL 8

Use this RTP to check Solenoids SOL3, SOL4, SOL5, SOL6, SOL7, and SOL8.

1. Open the front the door and insert an Interlock Cheater into the Punch Door interlock Switch SW4 (PL 1.2).

WARNING

Moving Parts, keep hands clear of nips and the belts when the Interlock Cheater is inserted.

2. Do GP 6.2.6 *SOLENOIDS Procedure* to activate and deactivate the affected solenoid.

When the solenoid is not activated, the idler roller should be able to rotate freely, and in turn drive the drive roller.

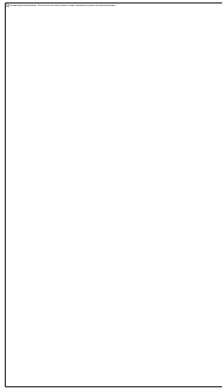

not activated

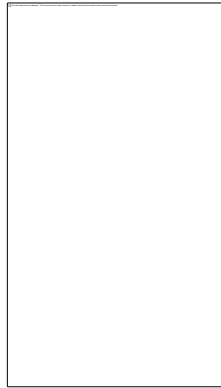

fully activated

When the solenoid is fully activated, the idler roller should completely lift off and not be able to drive the drive roller.

NOTE: Disengaging solenoid modules need to be Replaced every 5 million cycles.

To check the holding force of the solenoid, go to Step 3

If the solenoid does not actuate, go to Step 4

Alternate solenoid inspection method:

Mark a line on the idler roller shaft as shown in the picture.

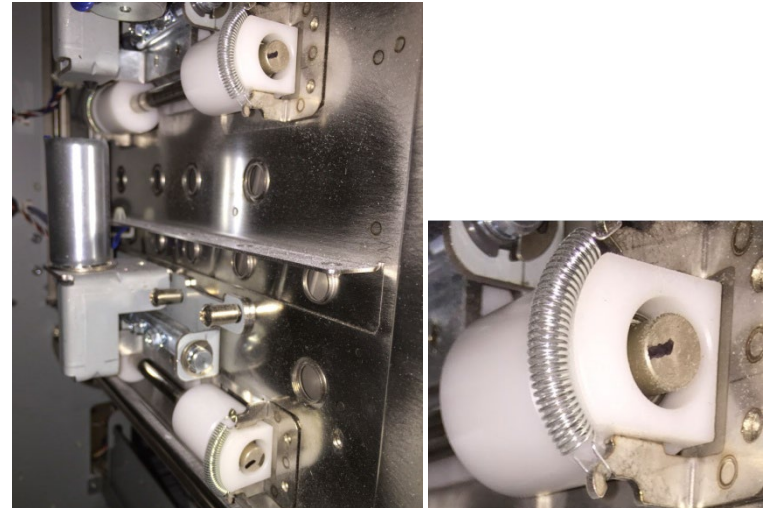

Motor running + Solenoid actuated = Line not visible

Motor running + Solenoid not actuated = Line visible

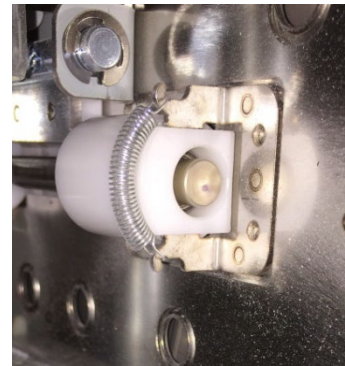

Picture shows Motor running and solenoid actuated.

From the service mode solenoid can be actuated using GP 6.2.6 Solenoids Procedure, and the corresponding drive roller rotated manually to check this.

3. Do the following to check the holding force of the Solenoid:
 - Activate a good solenoid and the solenoid in question (bad solenoid).
 - Try to push the plunger of the solenoid away from the body of the solenoid. Both solenoids should have approximately the same holding force. If the bad solenoid's Holding force is low, do ARP 2.28 Solenoid Replacement to Replace the Solenoid (PL 2.8).

This clears the fault

Yes- Return to normal operation; **No-** Go to Step 6

4. If the solenoid does not activate at all, inspect the cables from solenoid to header to control board- See Section 7 Wiring

The solenoid cables look okay

Yes- Go to Step 5; **No-** Replace the faulty solenoid module ARP 2.28

5. Do ARP 2.28 Solenoid Replacement to replace the faulty Solenoid (PL 2.8).

This clears the fault

Yes- Return to normal operation; **No-** Go to Step 6

6. Do GP 6.2.12 FIRMWARE UPGRADE Procedure to Re-flash the firmware for the STREAMPUNCH VF.

This clears the fault

Yes- Return to normal operation; **No-** Go to Step 7

7. Replace the cable from header to the main control for the solenoid in question. 7715466 or 7715467, see Section 7 Wiring

This clears the fault

Yes- Return to normal operation; **No-** Go to Step 8

8. Do ARP 5.1 to Replace the Main Control Board (PL 6.1).

This clears the fault

Yes- Return to normal operation; **No-** Escalate to second level

5 MOTOR CHECKS

RTP 5.1 Checking Stepper Motors

Use this RTP to check Stepper Motors.

1. Open the front the door and insert an Interlock Cheater into the Punch Door interlock Switch SW4

WARNING

Moving Parts, keep hands clear of nips and the belts when the Interlock Cheater is inserted.

2. For motors M1, M2, M3, M4, M6, M7, and M8; do *GP 6.2.7 Motors Procedure* to check that the corresponding nip rollers turn (check Drive and idler Rollers, see PL 2.6 and PL 4.2 for the identifying the motors.

For Motor M5, do *GP 6.2.8 FUNCTION TESTS Procedure* (Aligner Test).

The table below identifies the nip rollers driven by the corresponding motors:

Motor	Nip rollers
M1	N2, N3 and N4
M2	N5
M3	N6- Front side steering roller
M4	N7- Rear side steering roller
M5	Alignment Carriage
M6	N8, N9
M7	N10
M8	N1, N11, N12, N13, N14

3. Do ARP 1.6 to remove the Rear Cover.
4. If you are troubleshooting M3 or M4 or M5, do the below step, for other motors directly go to Step 5.
All the below connections are explained in detail in ARP3.1 Punch module Removal/Installation.
M3- Make sure the connector for M3 is inserted into the header at the back of the punch module.
M4- Make sure the connector for M3 is inserted into the header at the back of the punch module.

M5- Make sure the connector from M5 stepper motor is inserted into the driver board for motor M5.

All the connectors are securely connected.

Yes- Go to Step 5; **No-** Make the connection and resume operation

5. For the motor in question, make sure three connectors at the Stepper Driver board (J1, J2 and J3) and the below two connectors at the Main Control Board are inserted firmly.

J17 and J16 for M3, M4 and M5

J17 and J15 for M6, M7 and M8

J17 and J14 for M1 and M2

All the connectors are securely connected.

Yes- Go to Step 6; **No-** Make the connection and resume operation

6. Inspect the timing belt for the correspond motor drive- *GP 6.21 Timing Belt Inspection*. Follow the procedure to inspect the belts and Replace if necessary (ARP 2.22).

Note: If the timing belt of motor M5 is damaged (PL 4.3), do ARP 3.11 to replace the entire Alignment Carriage Sub Assembly.

For M5 Alignment Stepper Motor- Inspect the open ended belt in Alignment carriage Sub assembly (PL 4.3). If it is damaged, Replace the Alignment Carriage sub assembly (ARP 3.11)

All timing belts are okay

Yes- Go to Step 7; **No-** Replace the faulty belt and resume operation

7. Check the tightness of the set screw of pulley on the stepper motor shaft (Stepper and Mount assembly PL 2.6). Also check the set screws/ coiled spring pins for all the pulleys that are driven by the stepper motor in question.

All the set screws are secured tightly

Yes- Go to Step 8;

No- Tighten the loose set screw and resume operation

8. For the motor in question, check the DIP switch settings for the corresponding Driver Board (see ARP 2.26).

All the DIP switch setting are correct

Yes- Go to Step 9; **No-** Correct the DIP switch and resume operation.

9. Check if there is power to the Driver board. LED 1 on the Driver board should be lit.
If LED 1 is lit, it means there is 24V DC power to the Driver board from the Main Control board.
If LED 2 is lit, it means there is a fault with either the Driver board or the stepper motor.
Continue to Step 10
10. Check the cable connecting the stepper motor to the Driver Board (hard-wired to motor); and two cables connecting driver board to Main Control Board
7715477 and 7715470 for M3, M4 and M5
7715477 and 7715473 for M6, M7 and M8
7715477 and 7715468 for M1 and M2
The cables are not damaged
Yes- Go to Step 11;
No- Replace the faulty cable and resume normal operation
11. Do GP 6.2.12 FIRMWARE UPGRADE Procedure to Re-flash the firmware for the STREAMPUNCH VF.
This clears the fault
Yes- Resume normal operation; **No-** Go to Step 12
12. Replace the driver board for the faulty motor, with DIP switch set correctly for the position you are replacing- ARP 2.26
This clears the fault
Yes- Resume normal operation; **No-** Go to Step 13
13. Replace the faulty stepper motor
ARP 2.24 for M1, M2, M6, M7 and M8
ARP 3.12 for M3 and M4
ARP 3.8 for M5
This clears the fault
Yes- Resume normal operation; **No-** Go to Step 14
14. Replace the cables from control board to driver board.
If LED1 of any of the driver board is not lit, Replace 7715477
For other issues, Replace one of the below cables:
7715470 for M3, M4 and M5
7715473 for M6, M7 and M8
7715468 for M1 and M2.
This clears the fault
Yes- Resume normal operation; **No-** Go to Step 15
15. Replace Main Control Board (ARP 5.1)
This clears the fault
Yes- Resume normal operation; **No-** Escalate to next level

6 OTHER FAULTS

RTP 6.1 Die Set Will Not Slide In or Out Easily

Use this RTP when the Die Set will not slide in or out using a moderate pull.

1. Do GP 6.27 *Die Lock Mechanism and Die Rail Springs Inspection*.

This clears the fault

Yes- Return to normal operation; **No-** Go to Step 2

2. Check if the Punch Cam needs to be indexed. Do ADJ 1.5 *Punch Clutch Indexing* and perform the adjustment if necessary.

This clears the fault

Yes- Return to normal operation; **No-** Escalate to second level

RTP 6.2 Punch Overheats

Use this RTP if the Punch Overheats.

Note: To prevent excessive heat build-up, the maximum recommended monthly punch volume should not exceed 400,000. In addition, no more than 2 sheets of 300gsm per 5 sheets of 75 gsm.

1. Check that the Exhaust Fan operates when power is on. Do GP 6.2.8 *Function Tests- Fan Test*.

The exhaust fan operates

Yes- Go to Section 3.13 Punch specifications and make sure the machine is used per the Duty cycle specifications. Resume normal operation if specifications are met.

No- Go to step 2.

2. Check for obstructions at the vents in the Rear Cover.

There are no obstructions at the vents in the Rear cover

Yes- Go to Step 3

No- Clear the obstruction and resume normal operation.

3. Check for 24 VDC on Wire 7715267 at the Exhaust Fan.

There is 24 VDC

Yes- Replace the Exhaust fan (PL #)

No- Go to Step 4

4. Check for 24 VDC on Wire 7715267 at Connector J20 on the Control Board.

There is 24 VDC

Yes- Replace Wire 7715267.

No- Do RTP 1.2 No DC power.

Notes:

3. Punch Quality

Section Contents

Title	Page
3.1 Punch Quality	3
3.2 Initial Step.....	3
3.3 Hole Quality.....	4
3.3.1 Hanging Chad	4
3.3.2 Holes are not cleanly cut.....	4
3.3.3 Oil on Paper	4
3.4 Alignment Offset.....	4
3.5 Backgage Offset.....	5
3.6 Skewed Punch	6
3.7 Punching Accuracy Inconsistent	6
3.8 Sheets Without Punched Holes	9
3.9 Punched holes look elongated towards the trail edge of the sheet.....	10
3.10 Sheet Damaged at the Lead Edge of the Sheet	10
3.11 Scuff Marks on Paper.....	11
3.12 Wrinkle in the sheet.....	11
3.13 Clear Cover media hole position	11
3.14 Punch Specifications.....	12
3.15 Inconsistent Crease Depth.....	13
3.16 Inconsistent Perforation Quality	13

This page intentionally left blank.

3.1 Punch Quality

This section contains information related to the quality of the output such as hole quality or alignment.

3.2 Initial Step

Inspect the quality of the punch by referring to the specifications for Punch position and registration.

1. Do GP 6.1.8 DIE CYCLES Procedure to check the cycle life on the Die Set installed in the STREAMPUNCH VFX.
2. If any of the Die Set life cycles have exceeded 750,000 sheets (cycles) go to Section 3.3 and check the Hole Quality.
 - If the Punch Quality is acceptable monitor the Punch Quality frequently to ensure that the Punch Quality is okay.
 - If the Hole Quality is not acceptable replace the Die Set.
3. Defects in the appearance of the punch such as hole skew or non-uniformity are diagnosed in the following sections.

3.3 Hole Quality

There are three different Hole Quality problems:

- Hanging Chad
- Holes are not cleanly cut
- Oil on Paper

3.3.1 Hanging Chad

This is caused when the clearance between the pin and hole in a die-set increases.

Do GP 6.1.8 Die Cycles Procedure to check the number of cycles for the installed Die Set.

If Die Set cycles have exceeded 750,000, replace the Die Set with a new one.

3.3.2 Holes are not cleanly cut

This is usually caused due to lack of lubrication in the die-set. Do GP 6.7.3 Die Set Lubrication.

If lubricating the die set does not fix the issue, replace die-set.

3.3.3 Oil on Paper

After a die-set is lubricated the next 25-50 sheets will come out with oil around the punched holes. Running test sheets is recommended until oil marks cease to appear.

3.4 Alignment Offset

Use this procedure if the Alignment of all the punched sheets is consistently off.

If the Alignment is not consistent- go to Section 3.7 Punching Accuracy Inconsistent.

1. Is the die configured for the correct sheet size?

See Section 8 of STREAMPUNCH VFX User Manual for details.

Die-set is configured correctly

Yes- Go to Step 2;

No- Configure the die correctly and return to normal operation

2. Do GP 6.1.2 Alignment Offset

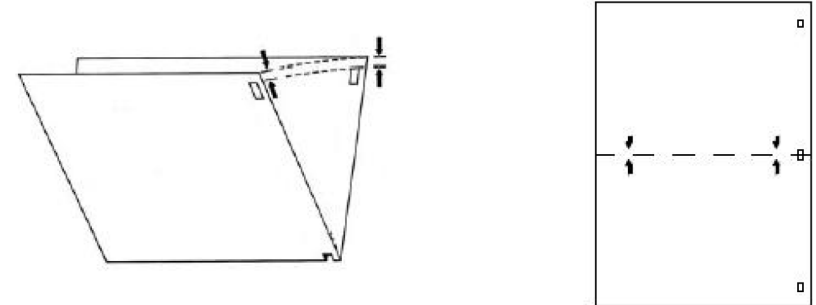

Figure 3-1 Hole Alignment on Finished Sheet

This clears the fault

Yes- Return to normal operation; **No-** Go to Step 3

3. Inspect the Die Stop Magnet. ADJ 1.3, Die Stop Adjustment.

This clears the fault

Yes- Return to normal operation; **No-** Go to Step 4

4. Inspect the die stop block of the die set, tighten if necessary.

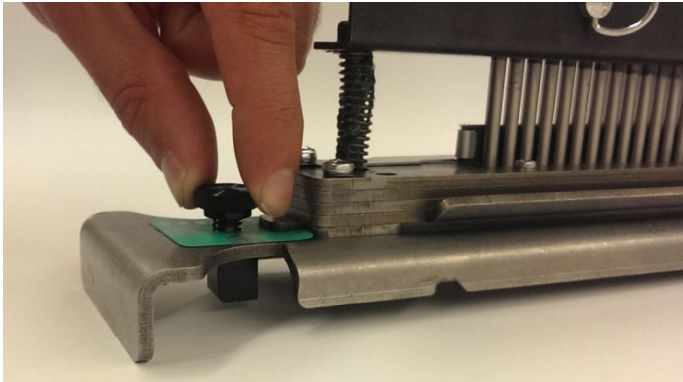

This clears the fault

Yes- Return to normal operation;

No- Go to Section 3.7 Punching accuracy inconsistent

3.5 Backgage Offset

Do the following steps if the Backgage is offset from correct position on all sheets consistently.

- If the backgage position is correct for the first punched sheet in a job and incorrect for all subsequent sheets, go to Step 4.
- If the punched hole positions are not consistent for all sheets, go to section 3.7 *Punching Accuracy Inconsistent*.

1. Do GP 6.1.1 Backgage Setting.

This clears the fault

Yes- Return to normal operation; **No-** Go to Step 2

2. If the backgage depth is too shallow (holes towards the trail edge of the sheet), do RTP 1.4 to check Solenoids SOL 6, SOL 7, and SOL 8.

This clears the fault

Yes- Return to normal operation; **No-** Go to Step 3

3. Do RTP 3.1 to check Sensors S22, S23 and S24.

This clears the fault

Yes- Return to normal operation;

No- Go to Section 3.7 *Punching Accuracy Inconsistent*

3.6 Skewed Punch

1. Check if the die is locked down properly. This is described in Section 4 (A) of the STREAMPUNCH VFX User Manual.

Die is properly locked

Yes- Go to Step 2;

No- Lock the die properly and return to normal operation

2. If the holes are consistently skewed, do GP 6.2.9 Skew Offsets Adjustment. Otherwise go to section 3.7 *Punching Accuracy Inconsistent*.

This clears the fault

Yes- Return to normal operation;

No- Go to Section 3.7 *Punching Accuracy Inconsistent*

3.7 Punching Accuracy Inconsistent

1. Check if the die is locked down properly, by inspecting the die lock plunger. This is described in Section 4 (A) of the STREAMPUNCH VFX User Manual.

Die is properly locked

Yes- Go to Step 2;

No- Lock the die properly and return to normal operation

2. Punching will be inaccurate if Solenoid SOL 6, SOL 7, or SOL 8 is not disengaging the roller completely when actuated (punched holes will be shifted towards the trail edge of the sheet in this case).
 - Do the following to check whether SOL6, 7 or 8 is causing the punch accuracy inconsistency,
 1. Leave the front door open and insert an interlock cheater.
 2. Leave the jam access panel of area #5 open.
 3. Run a 2~3 sheet job in punch job through the printer.
 4. Punched sheets will collect near area #5, gently pull the sheets and inspect the punch accuracy.
 5. If the punching accuracy is good, it means SOL6 or SOL7 or SOL8 is not functioning properly.
 6. Do RTP 4.3 to Check Solenoids SOL 6, SOL7 and SOL8.

For Double punched sheets, do RTP 4.3 to check Solenoids SOL 4 and SOL 5 in addition to the above steps.

This clears the fault

Yes- Return to normal operation; No- Go to Step 3

3. Do ARP 3.1.1 to remove the Punch module and do Steps 4, 5 and 6.
4. Do GP 6.27 Die Lock Mechanism and Die Rail Springs Inspection.

This clears the fault

Yes- Return to normal operation; No- Go to Step 5

5. Do GP 6.24 Punch Clutch Inspection and Cleaning.

This clears the fault

Yes- Return to normal operation; **No-** Go to Step 6

6. Check if the set screws in the pulleys of Aligner drive are secure. This can be checked by holding down the Alignment stepper pulley and trying to move the Aligner carriage on its rails. There should not be any play in the mechanism.

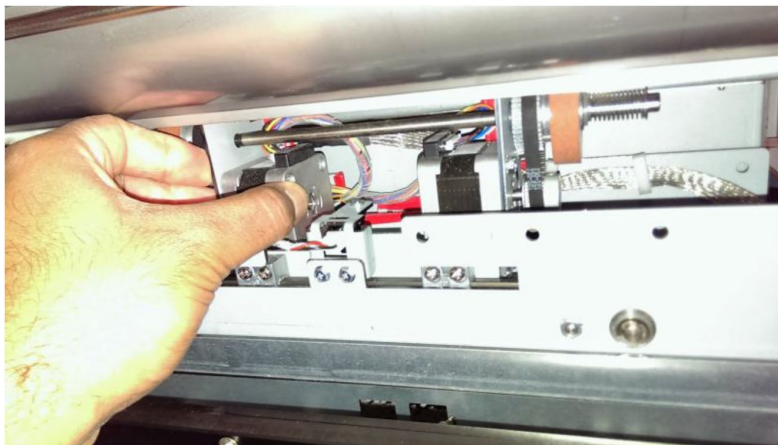
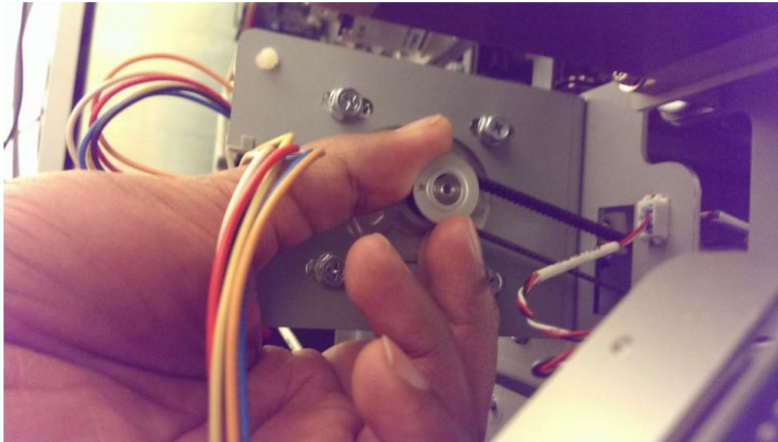

The set screws are secured tightly.

Yes- Go to Step 7;

No- Tighten set screw(s) and return to normal operation

7. There are 4 pulleys involved in the Aligner drive.

- Drive pulley of the Alignment stepper motor
- Driven pulley of the Alignment Stepper motor
- Pulley adjacent to the driven pulley (secured with a coiled pin)
- Pulley on the other shaft of the Aligner drive (secured with an coiled pin)

Make sure all the set screws are tightened securely, and the coiled pins are not broken.

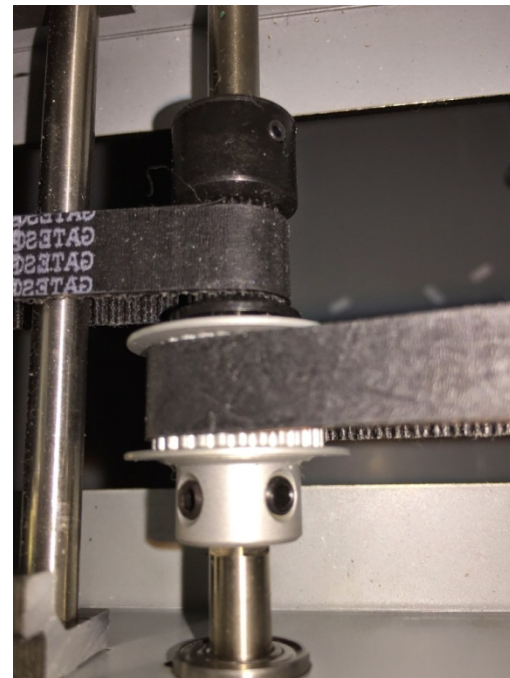

(Cont.)

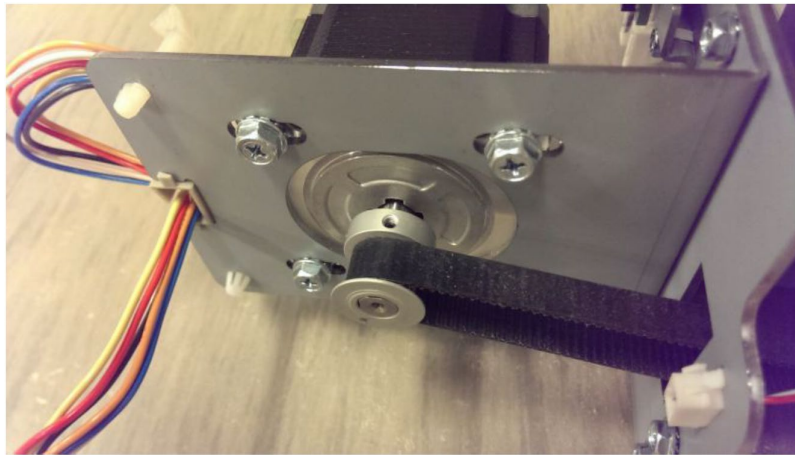

The set screws are secured tightly.

Yes- Escalate to higher level

No- Tighten set screw(s) and return to normal operation

3.8 Sheets Without Punched Holes

If all the sheets come out without punched holes, follow this procedure

1. Do RTP 4.1 to check the Diverter Solenoid.

This clears the fault

Yes- Return to normal operation; **No-** Go to Step 2

2. Do RTP 3.2 to Check Sensors S6, S7, S8, S9 and S10. If it is Double punch job, also check S18, S19, S20, and S21.

This clears the fault

Yes- Return to normal operation; **No-** Go to Step 3

3. Do RTP 3.1 to Check Sensor S5.

This clears the fault

Yes- Return to normal operation; **No-** Go to Step 4

4. Do RTP 3.3 checking Sensor S28 Align Home Sensor.

This clears the fault

Yes- Return to normal operation; **No-** Go to Step 5

5. Do GP 6.2.8 Function Tests- Cycle Punch and do the following steps.

6. If you do not hear the Punch cycles and do not hear the AC Motor running, remove the Rear Cover and do step 7.

If you do not hear the punch cycles, but you do hear the AC Motor Running, go to step 8 or step 9.

7. Check the AC Punch Motor connections at the header in the Rear Frame and the Control Board.

- Inspect the cable from the AC punch motor to the header and the cable from the header to Control board (7715476). If a cable is damaged, replace it.
- Do GP 6.2.12 FIRMWARE UPGRADE Procedure to Re-flash the firmware for the STREAMPUNCH VFX.
- With the Rear Cover removed, do GP 6.2.8 Function tests- Cycle Punch. Check the relay towards the bottom right of the main control board. You should be able to see the relay

make contact when the punch motor starts. If this does not happen, replace control board (ARP 5.1).



- If the relay makes contact, replace the AC Punch motor (ARP 3.5).

This clears the fault

Yes- Return to normal operation; **No-** Escalate to 2nd level

8. If the motor is running, but clutch is not operating:

- Remove the Rear Cover.
- Check connection at the clutch and control board, inspect clutch wires.
- Do GP 6.2.12 FIRMWARE UPGRADE Procedure to Re-flash the firmware for the STREAMPUNCH VFX.
- If the problem still exists, replace punch clutch.

This clears the fault

Yes- Return to normal operation; **No-** Go to Step 9

9. Check the Belt and Pulley for the AC Punch Motor.

- Inspect the timing Belt between the AC Punch Motor and the Clutch (PL 4.1).
- Check the tightness of the Setscrew of the AC Punch Motor (PL 4.11).

This clears the fault

Yes- Return to normal operation; **No-** Escalate to higher level.

3.9 Punched holes look elongated towards the trail edge of the sheet

This failure usually occurs when the Punch cycle is slowed.

1. Lubricate die-set. Do GP 6.7.3.

This clears the fault

Yes- Return to normal operation; **No-** Go to Step 2

2. Check if correct pulley is used depending on 115V or 230V machine, 115V machine should use 38T pulley and 230V machine should use 34T pulley (PL 4.8).

The correct pulley is used.

Yes- Go to Step 3; **No-** Change the pulley

3. Check the number of punch cycles of the machine, do GP 6.1.7 Punch Cycles. The normal life of the punch clutch is 15 million punch cycles. If the machines has completed 15 million punch cycles, do ARP 3.1 to replace the Punch Module.

The punch has less than 15 million cycles

Yes- Go to Step 4;

No- Replace the punch module (ARP 3.1)

4. Do GP 6.24 Punch Clutch Inspection and Cleaning.

This clears the fault

Yes- Return to normal operation; **No-** Escalate to higher level

3.10 Sheet Damaged at the Lead Edge of the Sheet

1. Do RTP 2.8 to check for an obstruction of the paper path.

This clears the fault

Yes- Return to normal operation; **No-** Go to Step 2

2. Remove the die set and inspect the die set throat for any obstruction.

This clears the fault

Yes- Return to normal operation; **No-** Escalate to higher level

3.11 Scuff Marks on Paper

1. Clean all drive and idler rollers, do
 - GP 6.14.1 Idler Roller Cleaning
 - GP 6.14.2 Steering Idler Roller and Springs Inspection and Cleaning
 - GP 6.15 Drive roller and Steering drive roller Inspection and Cleaning

This clears the fault

Yes- Return to normal operation; **No-** Go to Step 2

2. Do RTP 4.3 to inspect Solenoids SOL 3, SOL 4, SOL 5, SOL 6, SOL 7, and SOL 8.

This clears the fault

Yes- Return to normal operation; **No-** Go to Step 3

3. Do RTP 3.1 to inspect Sensors S3, S4, S5, S22, S23, and S24

This clears the fault

Yes- Return to normal operation; **No-** Escalate to higher level

3.12 Wrinkle in the sheet

1. If the wrinkling is at the trail edge of the sheet, Do RTP 3.1 to check Sensor S24.

This clears the fault

Yes- Return to normal operation; **No-** Go to Step 2

2. Do RTP 4.3 to inspect Solenoids SOL 6, SOL 7, and SOL 8.

This clears the fault

Yes- Return to normal operation; **No-** Escalate to higher level

3.13 Clear Cover media hole position

1. If the hole position (Backgage and Alignment) of Clear media differs from the hole position of plain media, do GP 6.1.3 CLEAR COVER Procedure

This clears the fault

Yes- Return to normal operation; **No-** Go to Step 2

2. Check the function of Sensor S1b.

Sensor S1b functions properly

Yes- Escalate to next level; **No-** Go to Step 3

3. Ensure the sensor S1b is connected properly on the receiver side and emitter side.

Sensor S1b is connected properly

Yes- Escalate to next level; **No-** Go to Step 4

4. Replace defective S1b receiver or emitter if needed.

New S1b sensors correct the issue.

Yes- Continue normal operation; **No-** Escalate to next level.

3.14 Punch Specifications

Speed	Up to 144 sheets per minute	
Punch Sheet Size and Edge LEF- Long Edge Fed SEF- Short Edge Fed	<p>US Sizes LTR LEF LTR SEF- Single and Double punch Statement LEF Legal SEF – Single and Double punch Ledger SEF- Single and Double punch 12x18 SEF – Single and Double punch</p> <p>ISO sizes A4 LEF A4 SEF- Single and Double punch A5 LEF A3 SEF- Single and Double punch SRA4 – Single and Double punch SRA3 – Single and Double punch</p>	
Paper Stock for Punch job	<p>Plain: 75gsm - 300gsm (20# bond to 110# cover)</p> <p>Coated: 120gsm - 300gsm (32# bond to 110# cover)</p>	
Bypass Mode Sheet size	75 gsm – 450 gsm	
Punch Capacity	Single Sheet	
Electrical	Amps and Frequency	115V: 4.2 A; 60 Hz 230V: 2.1 A; 50 Hz
Safety	cULus / GS	
Dimensions	L: 745mm; W: 445mm; H: 1100mm	
Weight	96 kg	

Sheet Entrance and Exit Specifications for Punch job

Curl variance at entrance	Max of 10mm from mid face to edge
Registration variance at pick up (includes skew)	±10mm from center
Speed variance at pick up	±2%
Skew variance at pick up	±25 millirads (1.43 degree)
Registration variance at exit (includes skew)	±2mm from center
Skew variance at exit	Punch: ±5 millirads (0.29 degree)
Speed variance at exit	±2%

Punch Accuracy

Hole Size	±2%
Alignment position	±0.5mm (with 1% ±0.5 to ±1.0mm)
Backgage Depth (at center)	±0.3mm (with 1% ±0.3 to ±0.8mm)
Skew	±0.6mm (with 1% ±0.6 to ±1.0mm)

3.15 Inconsistent Crease Depth

If the depth of crease or the quality of crease is inconsistent try the following steps to resolve the issue.

1. Lubricate the shoulder bolts according to the steps in GP 6.7.4. Ensure the shoulder bolts and bushings move freely following lubrication.

This clears the fault

Yes- Return to normal operation; **No-** Go to Step 2

2. Clean the crease die groove. Use a plastic pointed swab or similar to clear the toner or other debris from the crease groove. For more information, reference the “Crease & Perforation Die Cleaning” section of the User Manual.

This clears the fault

Yes- Return to normal operation; **No-** Go to Step 3

3. Check the springs on the crease die blade. Replace any damaged springs.

This clears the fault

Yes- Return to normal operation; **No-** Escalate to next level.

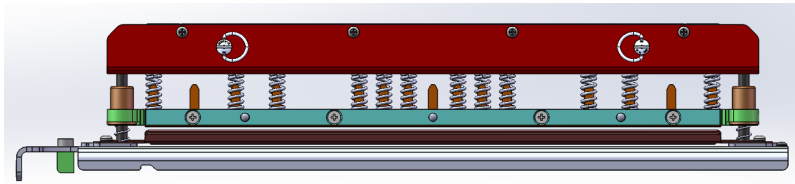

3.16 Inconsistent Perforation Quality

If the perforation quality is uneven or inconsistent, follow the following steps to resolve the issue.

1. Lubricate the shoulder bolts according to the steps in GP 6.7.4. Ensure the shoulder bolts and bushings move freely following lubrication.

This clears the fault

Yes- Return to normal operation; **No-** Go to Step 2

2. Clean the perforation backing plate using a cotton swab or similar cleaning device. If the backing plate is close to its expected life, proceed to Step 3.

This clears the fault

Yes- Return to normal operation; **No-** Go to Step 3

3. Replace the perforation backing plate. Follow the steps in the User Manual “Perforation Die Backing Plate Exchange” to replace the perforation backing plate.

This clears the fault

Yes- Return to normal operation; **No-** Go to Step 4.

4. Check the springs on the Perforation die blade. Replace any damaged springs. There are a total of 6 pressure springs on the Perf Die.

This clears the fault

Yes- Return to normal operation; **No-** Escalate to next level.

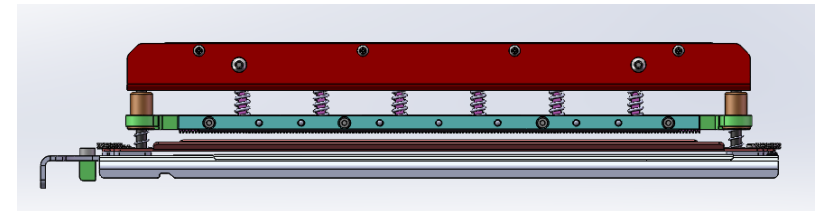

Duty Cycles

The GBC STREAMPUNCH VFX provides a flexible, cost effective punching solution for light to medium level punching production environments. It is designed for production print users that typically punch their documents at an average of 20-30% of their overall workflow. For customers that run continuous punching for long runs of over 4 hours, performance may vary or degrade due to a wide range of media weights and environmental conditions that can occur.

AMPV - Nominal 600,000 average monthly print volume (A4/letter), assuming volume is split 50/50 between punch and bypass (300,000 punch and 300,000 bypass).

Maximum Recommended Monthly Volume - The maximum recommended monthly punch volume should NOT exceed 400,000.

Maximum Punch Duty Cycle - In addition to the aforementioned conditions, no more than 2 sheets of 300gsm per 5 sheets of 75gsm should be punched. The heaviest paper stocks are typically used as only the front and back covers of the bound book application.

Crease & Perforation Operation – It is assumed that Creasing or Perforation operations will represent less than 50% of the average monthly print volume. If Creasing and Perforation operations represent more than 50% of all sheets, component wear may be accelerated.

4. Adjustments / Repairs Procedures

Section Contents

1. Cabinet	4-3
ARP 1.1 Top Cover Replacement.....	4-3
ARP 1.2 Front Door Replacement.....	4-4
ARP 1.3 Front Door Bottom Hinge Bracket Replacement	4-5
ARP 1.4 Front Door Top Hinge Bracket Replacement.....	4-5
ARP 1.5 Panel Open Magnet Replacement.....	4-6
ARP 1.6 Rear Cover Replacement	4-6
ARP 1.7 Upstream Rear Side Cover Replacement	4-7
ARP 1.8 Downstream Front Side Cover Replacement	4-7
ARP 1.9 Downstream Rear Side Cover Replacement.....	4-8
ARP 1.10 Door Latch Replacement	4-8
ARP 1.11 Interlock Switch Replacement	4-9
ARP 1.12 LCD Display Replacement.....	4-10
ARP 1.13 LCD Membrane Switch Panel Replacement	4-12
ARP 1.14 Caster Replacement	4-13
ARP 1.15 Docking Bracket Replacement	Error! Bookmark not defined.
ARP 1.16 Exhaust Fan and Exhaust Fan Bracket Replacement.....	4-13
ARP 1.17 Drive roller cover removal.....	4-14
ARP 1.18 Side cover removal	Error! Bookmark not defined.
2. Paper Path	4-16
ARP 2.1 Lower Entrance Panel Replacement	4-16
ARP 2.2 Inner Entrance Panel Replacement.....	4-17
ARP 2.3 Entrance Idler Panel Replacement.....	4-18
ARP 2.4 Acceleration Roller Idler Assembly Replacement.....	4-21
ARP 2.5 Entrance Drive Panel Assembly Replacement.....	4-23
ARP 2.6 Lower Exit Panel Replacement.....	4-27
ARP 2.7 Exit Idler Panel Replacement	4-28
ARP 2.8 Drive Exit Panel Replacement	4-31
ARP 2.9 Punch Lower Exit Panel Replacement	4-33

Title

Page

ARP 2.10 Inner Exit Panel Replacement.....	4-34
ARP 2.11 Upper Bypass Panel Replacement	4-35
ARP 2.12 Lower Bypass panel replacement	4-37
ARP 2.13 Bypass Diverter Replacement.....	4-38
ARP 2.14 Panel Close Magnet Replacement	4-39
ARP 2.15 Idler Roller Replacement.....	4-40
ARP 2.16 Idler Panel Mount Bracket Replacement	4-42
ARP 2.17 Flange Ball Bearing Replacement	4-43
ARP 2.18 Snap-in Bearing Replacement	4-44
ARP 2.19 Bearing Housing Replacement	4-45
ARP 2.20 Accel Idler Latch Handle Replacement.....	4-45
ARP 2.21 Accel Idler Latch Shaft, Rear Latch and Front Latch Assembly Replacement	4-46
ARP 2.22 One Way Clutch and Pulley Sub-Assembly Replacement	4-50
ARP 2.23 Drive Idler Roller Assembly Replacement	4-50
ARP 2.24 Timing Pulley Replacement	4-51
ARP 2.25 Timing Belt Replacement	4-52
ARP 2.25.1 534T Belt Replacement	4-52
ARP 2.25.2 134T Belt Replacement	4-53
ARP 2.25.3 150T Belt Replacement	4-54
ARP 2.25.4 179T Belt Replacement	4-54
ARP 2.26 Drive Roller Assembly Replacement	4-55
ARP 2.26.1 Drive Roller N5 Replacement	4-57
ARP 2.27 Stepper and Mount Assembly Replacement.....	4-60
ARP 2.28 Paper Path Sensor Replacement.....	4-61
ARP 2.28.1 Entrance Sensor (S1,) Exit Sensor (S25), and Bypass Middle Sensor (S26) Replacement.....	4-61
ARP 2.28.2 Top, Middle, & Bottom Entrance Sensor (S2, S3, S4) and Top, Middle, & Bottom Exit Sensor (S22, S23, S24) Replacement.....	4-62
ARP 2.28.3 Accel Sensor (S5) Replacement.....	4-63
ARP 2.28.4 Align Home Sensor (S28) Replacement.....	4-64

ARP 2.28.5 Backage Sensor Board Assembly (S18, S19) and Backage Sensor Board Assembly (S20, S21) Replacement.....	4-65	ARP 3.19 Punch shaft Ball Bearing Replacement.....	4-110
ARP 2.28.6 Skew Sensor Board (S6 – S10) Replacement.....	4-66	ARP 3.20 Die Stop Magnet Replacement.....	4-110
ARP 2.28.7 Alignment Sensor Board (S11 – S15) Replacement	4-67	ARP 3.21 Die Lock Handle Replacement.....	4-111
ARP 2.28.8 Backage Sensor Board (S16, S17) Replacement	4-69	ARP 3.22 Die Lock Shaft Replacement.....	4-112
ARP 2.29 Motor Driver (Stepper Board) Replacement.....	4-70	ARP 3.23 Die Rail Assembly and Die Rail Springs Replacement	4-114
ARP 2.30 Solenoid Replacement.....	4-71	ARP 3.24 Alignment Sensor Bracket and Alignment Sensor Bottom Guide Replacement.....	4-116
ARP 2.30.1 Diverter Solenoid Replacement	4-71	ARP 3.25 Punch Module Mount Pin Replacement	4-118
ARP 2.30.2 Entrance Idler Solenoid Replacement	4-73	ARP 3.26 Backgage Sensor Bracket Weldment and Backgage Sensor Lower Bracket Replacement	4-119
ARP 2.30.3 Acceleration Roller Idler Solenoid Replacement	4-73	ARP 3.27 Die Set Recognition Replacement.....	4-120
ARP 2.30.4 Exit Idler Solenoid Replacement.....	4-74		
ARP 2.31 Upper Bypass Panel Anti-Static Brush Replacement	4-74	4. Power Supply	4-121
3. Punch Module	4-75	ARP 4.1 24V Power Supply Replacement.....	4-121
ARP 3.1 Punch Module Replacement.....	4-75	ARP 4.2 AC Filter Replacement	4-123
ARP 3.1.1 Punch Module Removal.....	4-75	5. Electronics and Control	4-124
ARP 3.1.2 Punch Module Installation.....	4-79	ARP 5.1 Main Control Board Replacement	4-124
ARP 3.2 Chip Tray Home Switch Replacement	4-80	ARP 5.2 Comm Board Replacement	4-126
ARP 3.3 Chip Level Emitter Replacement.....	4-81	ARP 5.3 Dieset Recognition Reader Board Replacement.....	4-127
ARP 3.4 Chip Level Receiver Replacement.....	4-81	6. Adjustments	4-128
ARP 3.5 Punch Motor Replacement.....	4-82	ADJ 1.1 Door Latch Adjustment	4-128
ARP 3.6 Punch Motor Belt Replacement (Timing Belt).....	4-83	ADJ 1.2 Diverter Solenoid Adjustment	4-129
ARP 3.7 Clutch or Clutch Pulley Replacement.....	4-85	ADJ 1.3 Die Stop Magnet Adjustment.....	4-131
ARP 3.8 Punch Alignment Stepper Motor and Pulley Replacement, and Alignment Stepper Bracket Replacement	4-88	ADJ 1.4 Timing Belts Adjustment.....	4-132
ARP 3.9 Steering Module Replacement.....	4-89	ADJ 1.5 Punch clutch Indexing	4-137
ARP 3.10 Ground Strap Replacement.....	4-92	ADJ 1.6 Dieset Recognition Board Adjustment.....	4-141
ARP 3.11 Alignment Carriage Sub Assembly Replacement	4-94	ADJ 1.7 Idler Panel Magnetic Latches Adjustment	4-142
ARP 3.12 Steering Stepper Motor Replacement.....	4-97	ADJ 1.8 Drive Panel Position Adjustment	4-143
ARP 3.13 Steering Motor Belt (65 Groove) Replacement.....	4-99		
ARP 3.14 Steering Drive Roller Shaft Replacement	4-101		
ARP 3.15 Steering Idler Panel Weldment Replacement	4-103		
ARP 3.16 Steering Idler Roller Assembly Replacement.....	4-105		
ARP 3.16.1 Steering Idler Roller Bearing Replacement.....	4-107		
ARP 3.17 Steering Drive Panel Weldment Replacement.....	4-108		
ARP 3.18 Die Lock Plunger and Stripper Assembly Replacement	4-109		

REPLACEMENTS

1. Cabinet

ARP 1.1 Top Cover Replacement

PARTS LIST ON PL 1.2

Use this procedure to remove and install the Top Cover Assembly.

Removal Procedure

WARNING

Do not perform Repair activities with the power on or electrical power supplied to the machine. Some machine components contain dangerous electrical voltages that can result in electrical shock and possible serious injury.

1. Disconnect the Power Cord.
2. Open the Front Door.
3. Do ARP 1.6 to remove the Rear Cover.
4. Remove the Phillips Head Screws (4) from the Top Cover Tabs. (2 screws from front side and 2 screws from rear side)



5. Disconnect the LCD Connector and release the LCD Cable from wire saddles.
6. Remove the Top Cover.

Installation Procedure

Use this procedure to install the Top Cover Assembly.

1. Place the Top Cover in position so the Tabs overlap the front and rear frame.
2. Install and tighten the Phillips Head Screws (4) through the Tabs.
3. Connect the LCD Connector and place the LCD Cable in the wire saddles
4. Close the Front Door.
5. Do ARP 1.6 to install the Rear Cover.
6. Connect the Power Cord.

ARP 1.2 Front Door Replacement

PARTS LIST ON PL 1.2

Use this procedure to remove and install the Front Door Assembly

Removal Procedure

WARNING

Do not perform Repair activities with the power on or electrical power supplied to the machine. Some machine components contain dangerous electrical voltages that can result in electrical shock and possible serious injury.

1. Disconnect the Power Cord.
2. Open the Front Door.
3. Remove the Screws (2) from the Front Door Bottom Hinge Bracket. Support the door while removing the screws and gently slide it down.



4. Lower the Door down off the pin on the Front Door Top Hinge Bracket.
5. Remove the Front Door.
6. Remove the Interlock Switch (PL 1.2) from the old Door and install it on the new Door.
7. Remove the Magnet Strike Plate from the old Door and install it on the new Door.

Installation Procedure

1. Insert the Front Door Top Hinge Bracket into the slot at the top of the Front Door.



2. Insert the bottom door pin into the Front Door Bottom Hinge Bracket
3. Screw the Front Door Bottom Hinge Bracket into the frame



4. Close the Front Door.
5. Do ADJ 1.1 to adjust the Door Latch.
6. Connect the Power Cord.

ARP 1.3 Front Door Bottom Hinge Bracket Replacement

Use this procedure to remove and install the Front Door Bottom Hinge Bracket.

1. Press the Power Switch to the off position.
2. Disconnect the Power Cord.
3. Do ARP 1.2 Front Door Replacement to remove the Front Door.



Front Door
Bottom Hinge
Bracket

4. Remove the Screws (2) and the Front Door Bottom Hinge Bracket
5. Place the new Front Door Bottom Hinge Bracket in position and tighten the Screws (2).
6. Do ARP 1.2 Front Door Replacement to install the Front Door.
7. Connect the Power Cord.

ARP 1.4 Front Door Top Hinge Bracket Replacement

Use this procedure to remove and install the Front Door Top Hinge Bracket.

1. Press the Power Switch to the off position.
2. Disconnect the Power Cord.
3. Do ARP 1.2 Front Door Replacement to remove the Front Door.



Front Door
Top Hinge
Bracket

4. Remove the Screws (2) and the Front Door Top Hinge Bracket on the inside of the machine



5. Place the new Front Door Top Hinge Bracket in position and tighten the Screws (2).
6. Do ARP 1.2 Front Door Replacement to install the Front Door.
7. Connect the Power Cord.

ARP 1.5 Panel Open Magnet Replacement

Use this procedure to remove and install a Panel Open Magnet (PL 2.2).

1. Press the Power Switch to the off position.
2. Disconnect the Power Cord.
3. Open the Front Door.
4. Remove the Screws (2) and the Panel Open Magnet.

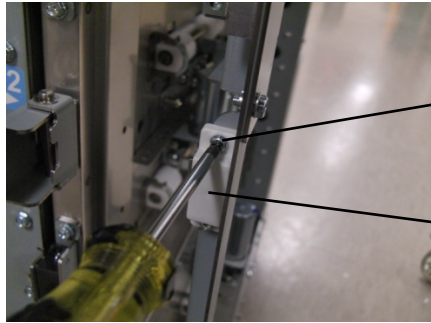

5. Place the Panel Open Bracket in position and tighten the Screws (2).
6. Close the Front Door.
7. Connect the Power Cord.

ARP 1.6 Rear Cover Replacement

PARTS LIST ON PL 1.2

Use this procedure to remove and install the Rear Cover Assembly

Removal Procedure

WARNING

Do not perform Repair activities with the power on or electrical power supplied to the machine. Some machine components contain dangerous electrical voltages that can result in electrical shock and possible serious injury.

1. Disconnect the Power Cord and all communication cables.
2. Hold the Rear Cover in place so it doesn't fall as you remove the M4 Screws (6) from the Rear Cover.
3. Grasp the Rear Cover by the handle and remove the Rear Cover.

Installation Procedure

1. Place the Rear Cover in position.
2. Tighten the Screws (6) on the Rear Cover.
3. Connect the Communication cables.
4. Connect the Power Cord.

ARP 1.7 Upstream Rear Side Cover Replacement

PARTS LIST ON PL 1.2

Use this procedure to remove and install the Upstream Rear Side Cover.

Removal Procedure

WARNING

Do not perform Repair activities with the power on or electrical power supplied to the machine. Some machine components contain dangerous electrical voltages that can result in electrical shock and possible serious injury.

1. Disconnect the Power Cord.
2. Do GP 6.3 to undock the Punch from the upstream and downstream equipment.
3. Do ARP 1.6 to remove the Rear Cover.
4. Remove the Screws (5) securing the Upstream Rear Side Cover
5. Remove the Upstream Rear Side Cover.

Installation Procedure

1. Place the Upstream Rear Side Cover in position.
2. Tighten the Screws (5) holding the Upstream Rear Side Cover.
3. Do ARP 1.6 to install the Rear Cover.
4. Do GP 6.4 to dock the Punch to the upstream and downstream equipment.
5. Connect the Power Cord.

ARP 1.8 Downstream Front Side Cover Replacement

PARTS LIST ON PL 1.2

Use this procedure to remove and install the Downstream Front Side Cover.

Removal Procedure

WARNING

Do not perform Repair activities with the power on or electrical power supplied to the machine. Some machine components contain dangerous electrical voltages that can result in electrical shock and possible serious injury.

1. Disconnect the Power Cord.
2. Do GP 6.3 to undock the Punch from the upstream and downstream equipment.
3. Remove the M4 Screws (6).
4. Remove the Downstream Front Side Cover.

Installation Procedure

1. Place the Downstream Front Side Cover in position.
2. Tighten the Screws (5).
3. Do GP 6.4 to dock the Punch to the upstream and downstream equipment.
4. Connect the Power Cord.

ARP 1.9 Downstream Rear Side Cover Replacement

PARTS LIST ON PL 1.2

Use this procedure to remove and install the Downstream Rear Side Cover.

Removal Procedure

WARNING

Do not perform Repair activities with the power on or electrical power supplied to the machine. Some machine components contain dangerous electrical voltages that can result in electrical shock and possible serious injury.

1. Disconnect the Power Cord.
2. Do GP 6.3 to undock the Punch from the upstream and downstream equipment.
3. Do ARP 1.6 to remove the Rear Cover.
4. Remove the Screws (7) holding the Downstream Rear Side Cover.
5. Remove the Downstream Rear Side Cover.

Installation Procedure

1. Place the Downstream Rear Side Cover in position.
2. Tighten the Screws (7) holding the Downstream Rear Side Cover.
3. Do ARP 1.6 to install the Rear Cover.
4. Do GP 6.4 to dock the Punch to the upstream and downstream equipment.
5. Connect the Power Cord.

ARP 1.10 Door Latch Replacement

PARTS LIST ON PL 1.2

Use this procedure to remove and install the Door Latch Assembly.

WARNING

Do not perform Repair activities with the power on or electrical power supplied to the machine. Some machine components contain dangerous electrical voltages that can result in electrical shock and possible serious injury.

Do the following to ensure the door latch holds the door closed and that the activating bracket tab [1] depresses the door switch[2]. The tab should press the switch button just so that it is close to bottoming out.

1. Disconnect the Power Cord.
2. Open the Front Door.



3. Remove the two screws [1] on the Door Latch.



Screw (2)

4. Remove Screws (2) from the Interlock Box.

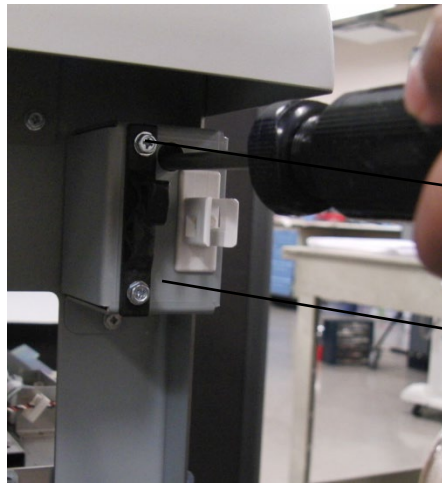

Screw (2)

Interlock
Box

5. Remove the old Latch and put the new Latch in position.
6. Do ADJ 1.1 to adjust the Door Latch.
7. Tighten the Screws (4).
8. Close the Front Door.
9. Connect the Power Cord.
10. Test the Door Latch operation.

ARP 1.11 Interlock Switch Replacement

PARTS LIST ON PL 1.2

Use this procedure to remove and install the Interlock Switch Assembly.

Removal Procedure

WARNING

Do not perform Repair activities with the power on or electrical power supplied to the machine. Some machine components contain dangerous electrical voltages that can result in electrical shock and possible serious injury.

1. Disconnect the Power Cord.
2. Open the Front Door.
3. Remove the M4 screws (2).



Nuts (2)

Interlock Switch
Bracket

4. Remove the Interlock Switch Bracket.
5. Press in the Tabs (2) on the sides of the Switch and remove the Interlock Switch from the Interlock Switch Bracket.

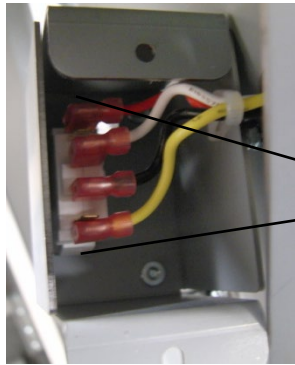

Tabs (2)

6. Note the location of the Wires (4); then disconnect the Wires from the Interlock Switch (PL 1.2).

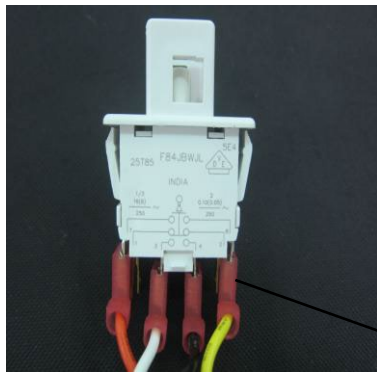

Wires (4)

From right to left:

- Yellow wire – Position 8.
 - Black wire – Position 4.
 - White wire – Position 3.
 - Orange wire – Position 7.
7. Place the new Interlock Switch into the Interlock Switch Bracket. and press down until the Tabs lock in place.
 8. Connect the Wires (4) to the new Interlock Switch.
 9. Place the interlock Switch Bracket in position, and tighten the screws (2).
 10. Close the Front Door.
 11. Connect the Power Cord.

ARP 1.12 LCD Display Replacement

PARTS LIST ON PL 1.2

Use this procedure to remove and install the LCD Display. Note: The Display can be removed without removing the top cover, but removing the top cover may make it easier to access the components. If it is difficult to access components, do ARP 1.1 to remove the Top Cover.

Removal Procedure

WARNING

Do not perform Repair activities with the power on or electrical power supplied to the machine. Some machine components contain dangerous electrical voltages that can result in electrical shock and possible serious injury.

1. Disconnect the Power Cord.
2. Open the Front Door.
3. Locate the LCD display under the top cover. Disconnect the large ribbon cable from the LCD Adapter board.



Cable

4. Disconnect the small ribbon cable from the LCD. The cable can be removed by gently pulling horizontally on the tabs of the cable connector to release it.



Cable

Installation Procedure

1. Place the new LCD Screen in position.
2. Tighten the Screws (4) holding the LCD Display to the Top Cover.
3. Connect the small Ribbon Cable to the LCD Screen. Place the ribbon cable flat and then secure the cable by pressing in on the plastic tabs of the cable connector.
4. Connect the large Ribbon Cable to the Adapter Board.
5. Close the Front Door.
6. Connect the Power Cord.

5. From the bottom side of the Top Cover, remove the Screws (4) holding the LCD Display to the Top Cover.

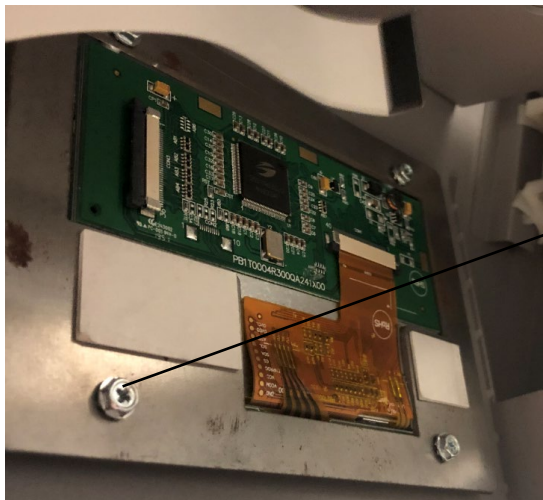

Screws

6. Remove the LCD Display.

ARP 1.13 LCD Adapter PCB Replacement

PARTS LIST ON PL 1.2

Use this procedure to remove and install the LCD Adapter PCB.

WARNING

Do not perform Repair activities with the power on or electrical power supplied to the machine. Some machine components contain dangerous electrical voltages that can result in electrical shock and possible serious injury.

1. Disconnect the Power Cord.
2. Open the Front Door.
3. Disconnect the large Ribbon Cable from the Adapter PCB.



Cable

4. Remove the small ribbon cable from the Adapter by gently pulling back on the plastic tabs of the cable connector.
5. Remove the M4 screws securing the Adapter PCB and remove the Adapter PCB.



Installation Instructions

1. Place the new Adapter PCB into the correct location on the top cover.
2. Secure the M4 screws (4) to attach the Adapter PCB to the Top Cover.
3. Reconnect the small ribbon cable to the Adapter PCB. Secure the cable by gently pushing in on the cable connector tabs
4. Reconnect the large Ribbon Cable to the Adapter PCB.
5. Close the Front Door.
6. Connect the Power Cord.

ARP 1.14 Caster Replacement PARTS LIST ON PL 2.2

Use this procedure to remove and install the Caster Assembly.

Removal Procedure

WARNING

Do not perform Repair activities with the power on or electrical power supplied to the machine. Some machine components contain dangerous electrical voltages that can result in electrical shock and possible serious injury.

1. Disconnect the Power Cord.
2. Carefully lift the corner of the Punch by the Caster.
3. Loosen the Jam Nut.

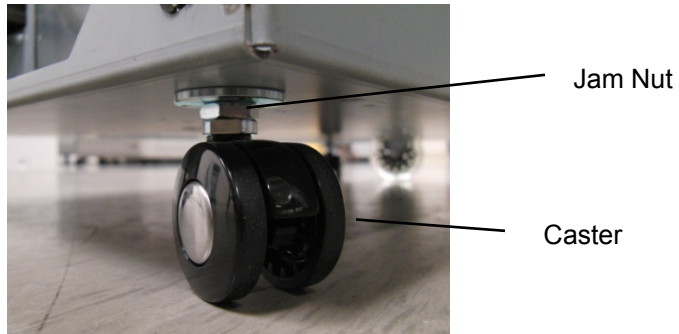

4. Unscrew the Caster to remove it.
5. Place the new Caster in position and screw it in.
6. Tighten the Jam Nut.
7. Lower the Punch
8. Connect the Power Cord.

ARP 1.15 Exhaust Fan and Exhaust Fan Bracket Replacement PARTS LIST ON PL 1.2

Use this procedure to remove and install the Exhaust Fan or the Exhaust Fan Bracket.

Removal Procedure

WARNING

Do not perform Repair activities with the power on or electrical power supplied to the machine. Some machine components contain dangerous electrical voltages that can result in electrical shock and possible serious injury.

1. Disconnect the Power Cord.
2. Do ARP 1.6 to remove the Rear Cover.
3. Remove the Screws (2) and the Exhaust Fan Bracket.

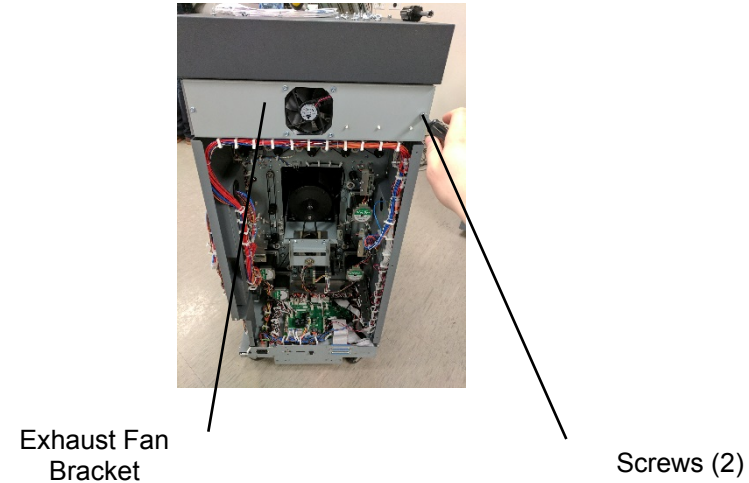

4. Do the following to remove the Exhaust Fan from the Exhaust Fan Bracket.
 - Disconnect Cable 7715267 at Connector J20 on the Control Board (see Section 7 Wiring).



- Open the Wires Saddles.
- Remove the Screws (4) from the front and the Nuts (4) from the rear of the Bracket.
- Remove the Exhaust Fan.

Installation Procedure

1. Do the following to install the Exhaust Fan on the Exhaust Fan Bracket.
 - Place the new Exhaust Fan in position on the Exhaust Fan Bracket.
 - **The fan should be installed such that air flows out of the machine. An arrow mark in the exhaust fan indicates the direction of air flow.**
 - Connect Cable 7715267 at Connector J20 on the Control Board (see Section 7 Wiring).
 - Install the Screws (4) from the front and tighten the Nuts (4) from the rear of the Bracket.
 - Place Cable 7715267 into the Wires Saddles.
2. Place the Exhaust Fan Bracket Assembly in position and tighten the Screws (2).
3. Connect Cable 7715267 at Connector J20 on the Control Board (PL 5.1).
4. Do ARP 1.6 to install the Rear Cover.
5. Connect the Power Cord.

ARP 1.16 Drive roller cover removal

Use this procedure to remove the cover for Drive rollers on the entrance side or exit side to get access to other parts.

Removal Procedure

1. Disconnect Power cord.
2. Do GP 6.3 to undock the Punch from upstream and downstream equipment
3. Do ARP 1.6 Rear Cover Replacement to remove the Rear Cover.
4. For the entrance side, remove (2) M4 screws from the front frame.

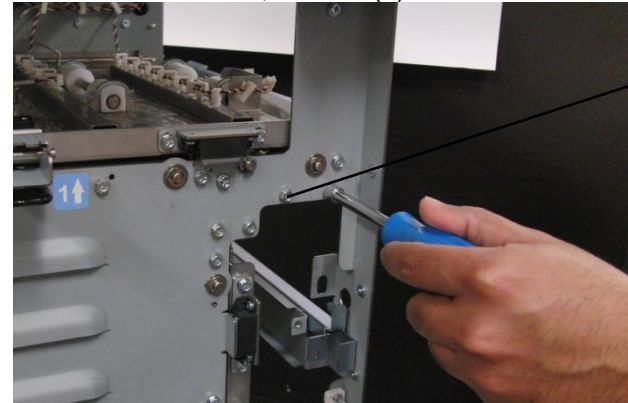

5. Remove (2) M4 screws from the rear frame.

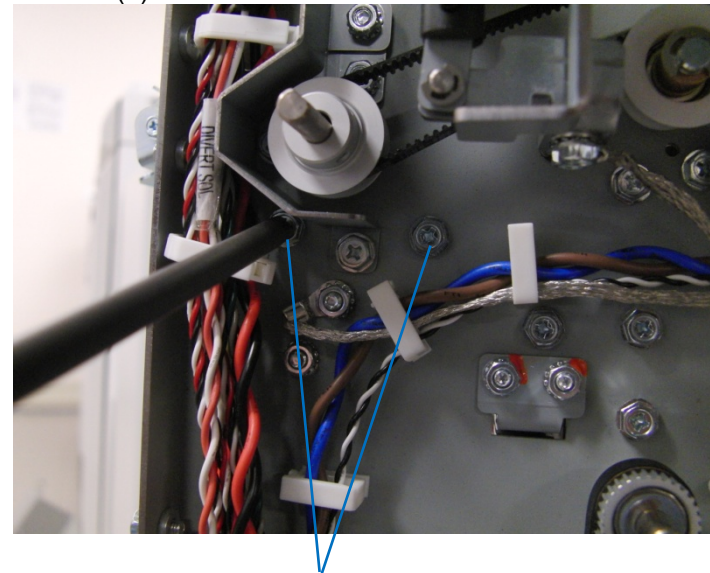

6. Remove the Drive roller cover.

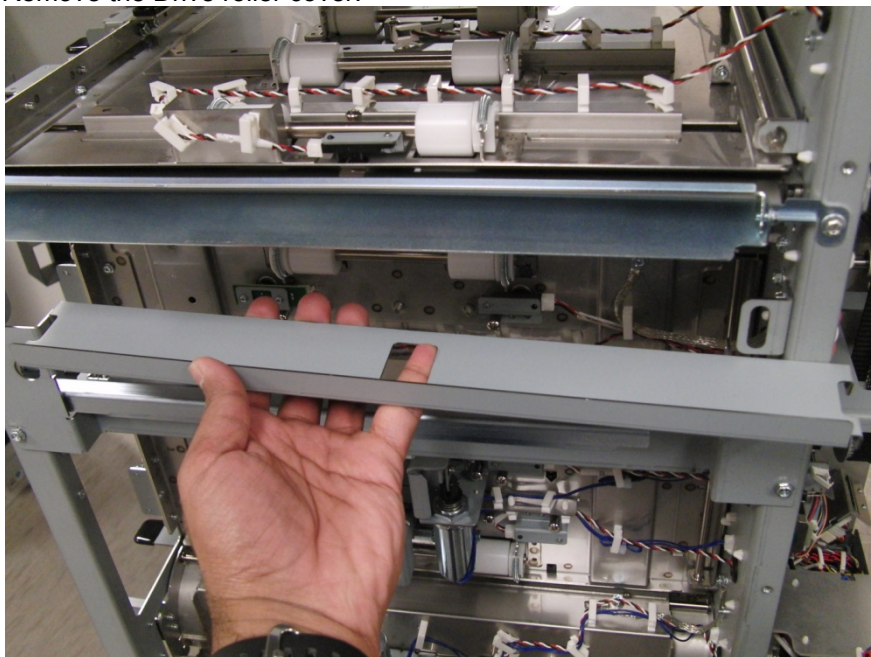

7. Use the same procedure for exit side drive roller cover by removing the corresponding screws.

Installation Procedure

Reverse steps to re-install the cover.

2. Paper Path

ARP 2.1 Lower Entrance Panel Replacement

PARTS LIST ON PL 2.1

Use this procedure to remove and install the Lower Entrance Panel.

Removal Procedure

1. Disconnect the Power Cord.
2. Do GP 6.3 to undock the Punch from the upstream and downstream equipment.
3. Do ARP 1.6 Rear Cover Replacement to remove the Rear Cover.
4. Do ARP 1.17 Drive Roller Cover removal for the entrance side cover.
5. Open the Upper Bypass Assembly.
6. Remove the Screws (2) from the Front Frame used to mount the Lower Entrance Panel.

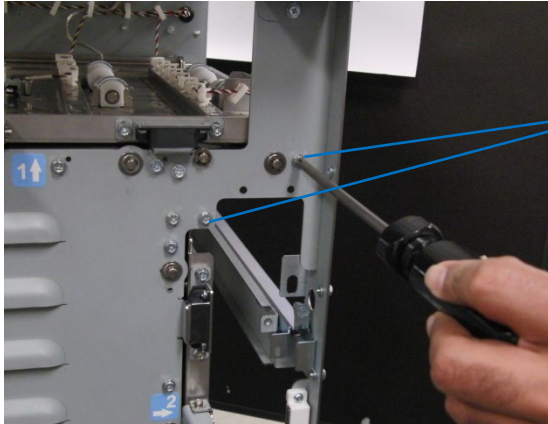

Screws (2)

7. Remove the Screws (2) from the Rear Frame used to mount the Lower Entrance Panel.

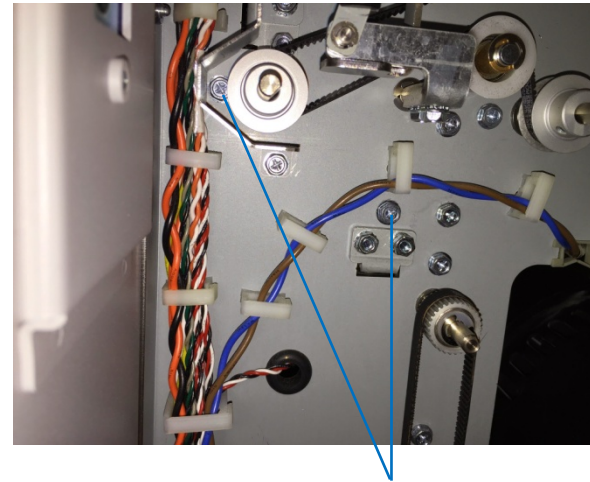

Screws (2)

8. Remove the Lower Entrance Panel.

Installation Procedure

1. Place the Lower Entrance Panel in position.
2. Tighten the Screws (4) used to mount the Lower Entrance Panel
3. Close the Upper Bypass Assembly.
4. Do ARP 1.6 Rear Cover Replacement to install the Rear Cover.
5. Do ARP 1.17 Drive Roller Cover removal to replace the cover.
6. Do GP 6.4 to dock the Punch to the upstream and downstream equipment.
7. Connect the Power Cord.
8. Do ADJ 1.2 Diverter Solenoid Adjustment.

ARP 2.2 Inner Entrance Panel Replacement

PARTS LIST ON PL 2.1

Use this procedure to remove and install the Inner Entrance Panel.

Removal Procedure

WARNING

Do not perform Repair activities with the power on or electrical power supplied to the machine. Some machine components contain dangerous electrical voltages that can result in electrical shock and possible serious injury.

1. Disconnect the Power Cord.
2. Do GP 6.3 *Undock the Punch* to separate the Punch from the upstream and downstream devices.
3. Do ARP 1.6 to remove the Rear Cover.
4. Do ARP 1.17 to remove the Lower Entrance Panel.
5. Remove the screws (2) from the front frame and the Screws (2) from the rear frame that are used to mount The Lower Entrance Panel.

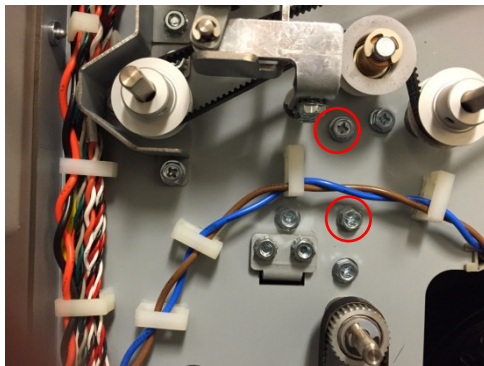
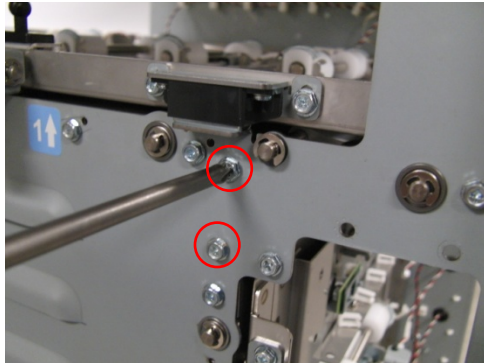

6. Remove the Inner Entrance Panel.

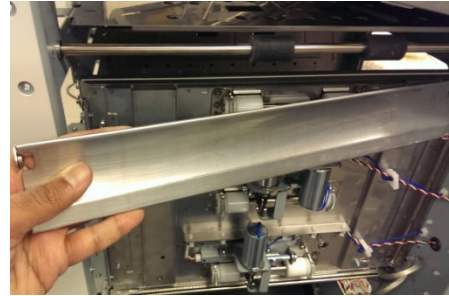

Installation Procedure

1. Place the Inner Entrance Panel in position.
Tighten the screws (2) in the front frame and the Screws (2) in the rear frame that are used to mount The Lower Entrance Panel.
2. Do ARP 1.17 to install the Lower Entrance Panel.
3. Do ARP 1.6 to install the Rear Cover.
4. Do GP 6.4 *Dock the Punch* to connect the Punch to the upstream and downstream devices.
5. Connect the Power Cord.

ARP 2.3 Entrance Idler Panel Replacement

PARTS LIST ON PL 2.2, PL 3.2

Use this procedure to remove and install the Entrance Idler Panel.

Removal Procedure

WARNING

Do not perform Repair activities with the power on or electrical power supplied to the machine. Some machine components contain dangerous electrical voltages that can result in electrical shock and possible serious injury.

1. Disconnect the Power Cord.
2. Open the Front Door.
3. Do GP 6.3 *Undock the Punch* to separate the Punch from the upstream and downstream devices.
4. Open the Cable Clamps to release all the sensor cables.



5. Disconnect the Connectors for Sensors S2, S3, & S4.

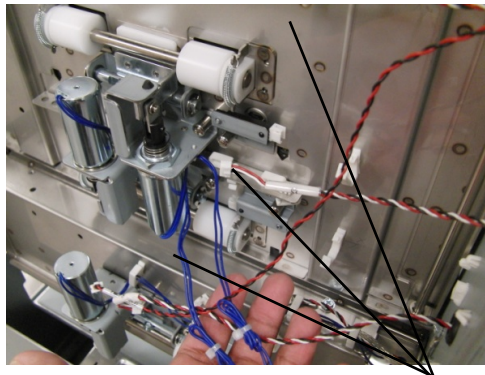

Sensor S2, S3, & S4 Connectors

6. Remove the screw for ground strap

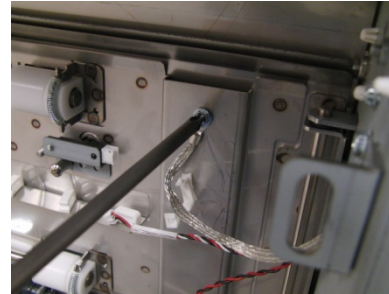

7. Disconnect the Connectors for Solenoids SOL3 & SOL4 from the header.

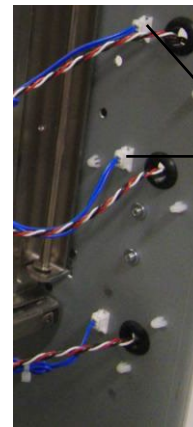

Solenoid SOL3 & SOL4 Connectors

8. Remove the E-Ring from the bottom of the Idler Panel Shaft.

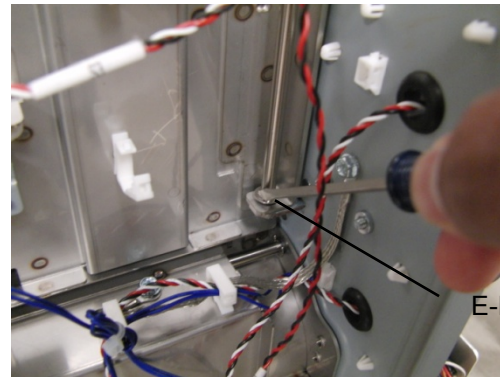

E-Ring

(Cont.)

9. Remove the E-Ring from the top of the Idler Panel Shaft.

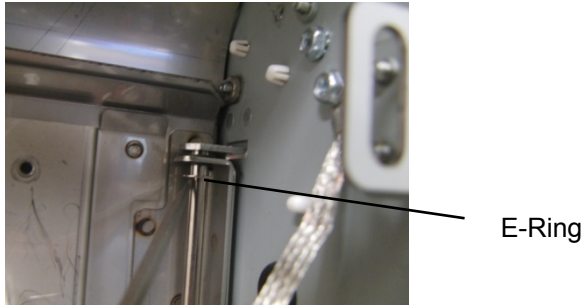

10. Open the Entrance Idler Panel from the front side.



11. Carefully remove the Shaft.

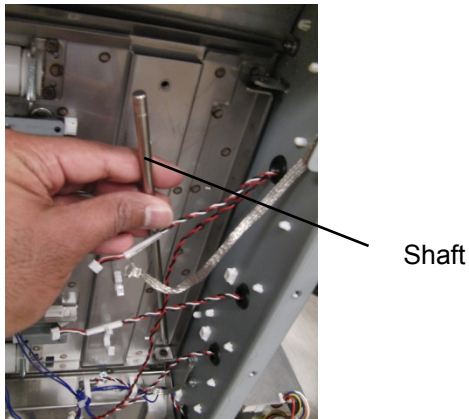

(Cont.)

12. Grasp and remove the Entrance Idler Panel.

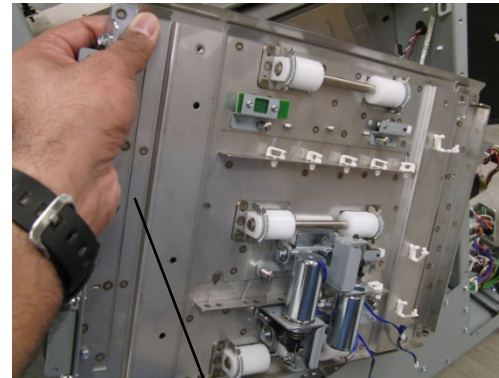

Entrance Idler Panel

13. Do the following to transfer the Sensors, Solenoid Modules, Idler Rollers, Springs, and Panel Magents to the new weldment.
- ARP 2.4 Idler roller Assembly Replacement
 - ARP 2.28.3 Sensor (S2, S3, S4) Replacement
 - ARP 2.30.2 Disengaging Roller Solenoid Replacement

Installation Procedure

1. Place the Entrance Idler Panel in position.
1. Insert the Shaft through the holes (2) at the left side of the Entrance Idler Panel.
2. Install the E-Rings (2) at the top and bottom of the Shaft.
3. Connect the Connectors for Solenoids SOL3 & SOL4 to the header.
4. Connect the Connectors for Sensors S2, S3, & S4.
5. Place the sensor cables into the Cable Clamps, and close the Clamps.
6. Install the screw for the ground strap.
7. Do ADJ 1.7 Idler Panel Magnetic Latches Adjustment.
8. Do GP 6.4 *Dock the Punch* to connect the Punch to the upstream and downstream devices.
9. Close the Front Door.
10. Connect the Power Cord.

ARP 2.4 Acceleration Roller Idler Assembly Replacement

PARTS LIST ON PL 3.1, PL 3.3

Do the following to replace the Acceleration Idler Roller Assembly (or the Accel Idler Panel Weldment).

Removal Procedure

1. Disconnect the Power Cord.
2. Do GP 6.3 *Undock the Punch* to separate the Punch from the upstream and downstream devices.
3. Open the Front Door.



Acceleration Idler panel Handle

4. Open the Acceleration Idler Roller Panel and remove the M4 screw for ground strap.



5. Open the Cable Clamps to release the Sensor Cable.

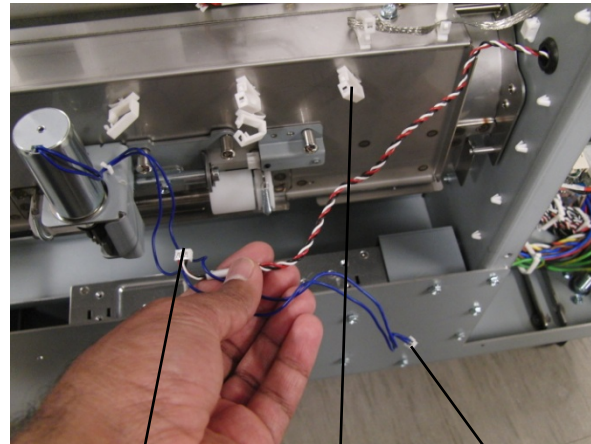

Sensor S5 Connector
Cable Clamps
Solenoid SOL5 Connector

6. Disconnect the Accel Sensor S5 Connector at the the sensor
7. Disconnect the Acceleration Idler Roller Solenoid SOL5 Connector at the rear frame.

(Cont.)

8. Remove the E-Ring (2) from each end of the Accel Idler Latch Shaft.

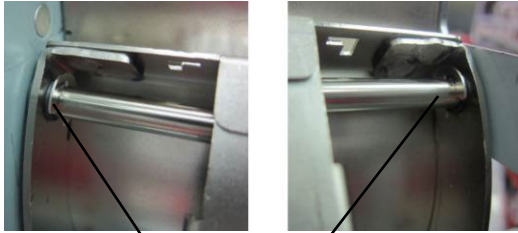

E-Ring

E-Ring

9. Remove the Accel Idler Latch Shaft.

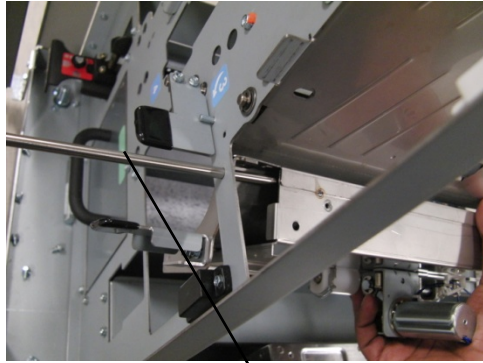

Shaft

10. Remove the Acceleration Idler Roller Assembly.

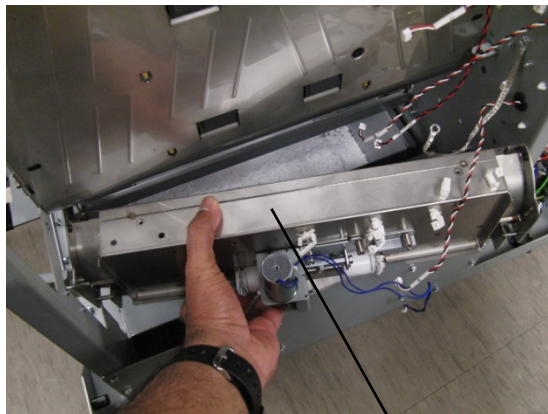

Acceleration Idler Roller Assembly

11. To replace the Accel Idler Panel Weldment do the following procedures to remove and install these components.

- ARP 2.28.3 Accel Sensor (S5) Replacement
- ARP 2.30.2 Disengaging Roller Solenoid Replacement

Installation Procedure

1. Place the Acceleration Idler Roller Assembly in position.
2. Slide the Accel Idler Latch Shaft through the holes in the frame and the holes at each end of the Acceleration Idler Roller Assembly.
3. Install the E-Ring (2) at each end of the Accel Idler Latch Shaft.
4. Connect the Acceleration Idler Roller Solenoid SOL5 Connector at the header.
5. Connect the Acccel Sensor S5 Connector.
6. Place the Cable in the cable Clamps and close the cable Clamps.
7. Grasp the Handle and close the Acceleration Idler Roller Panel.
8. Close the Front Door.
9. Do GP 6.4 *Dock the Punch* to connect the Punch to the upstream and downstream devices.
10. Connect the Power cord.

ARP 2.5 Entrance Drive Panel Assembly Replacement

PARTS LIST ON PL 2.1, PL 3.1

Use this procedure to remove and install the Entrance Drive Panel Assembly.

Removal Procedure

WARNING

Do not perform Repair activities with the power on or electrical power supplied to the machine. Some machine components contain dangerous electrical voltages that can result in electrical shock and possible serious injury.

1. Disconnect the Power Cord.
2. Do ARP 1.6 to remove the Rear Cover.

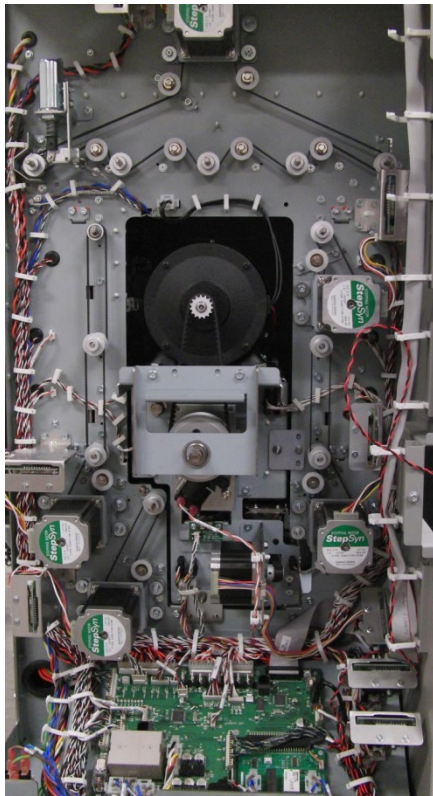

3. Do ARP 3.1 to remove the Punch Module.

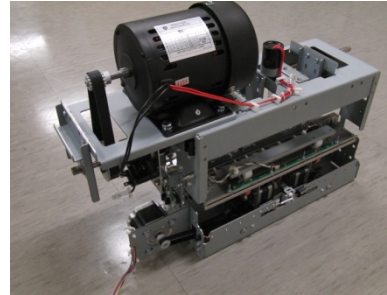

4. Do GP 6.3 *Undock the Punch* to separate the Punch from the upstream and downstream devices.
5. Do ARP 2.3 to remove the Entrance Idler Panel.

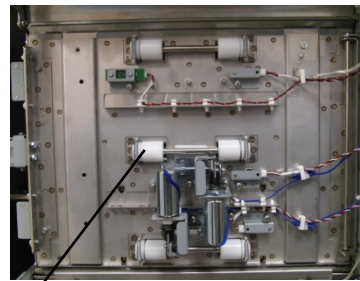

Entrance Idler Panel

(Cont.)

6. Do ARP 2.4 to remove the Acceleration Idler Roller Panel.

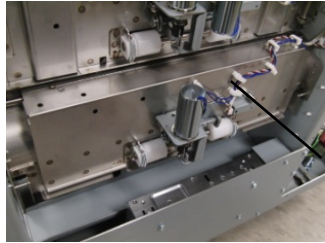

Acceleration Roller Idler Assembly

7. Unhook the Acceleration Panel Latch Springs (2).

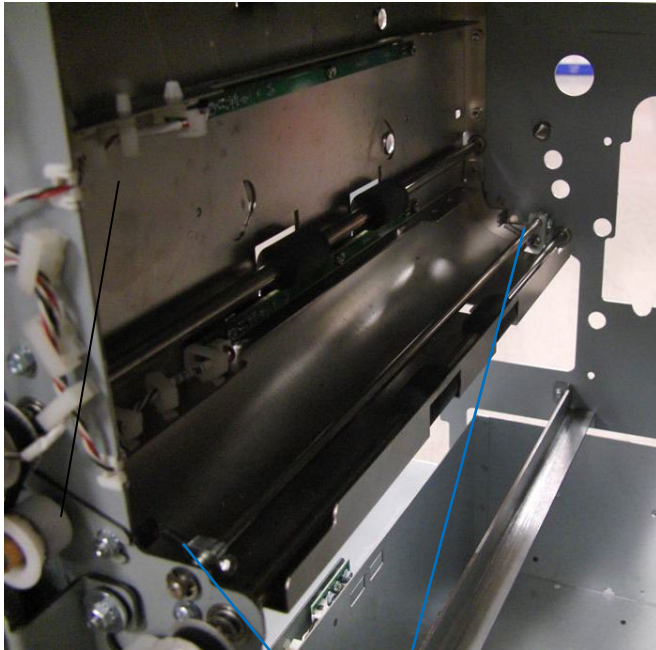

Acceleration Panel Latch Springs

8. Do ARP 2.26.1 to remove the Drive Roller for Roller N5.

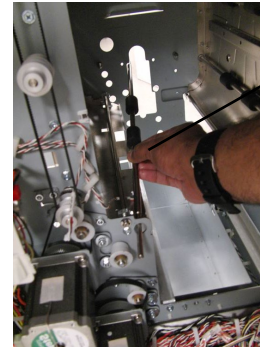

Drive Roller

9. Open the Cable Clamps and release the Sensor Cables.

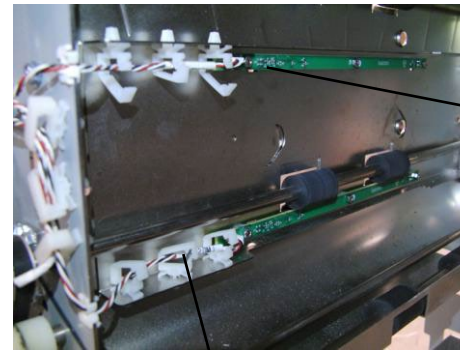

Sensor board connectors

Cable Clamps

10. Disconnect the Clear Cover Sensor.

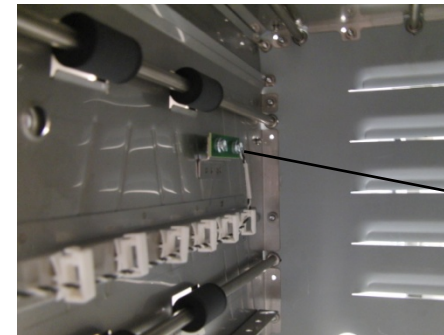

Clear Cover sensor

(Cont.)

11. Remove the Screws (5) that hold the Entrance Drive Panel to the front Frame.

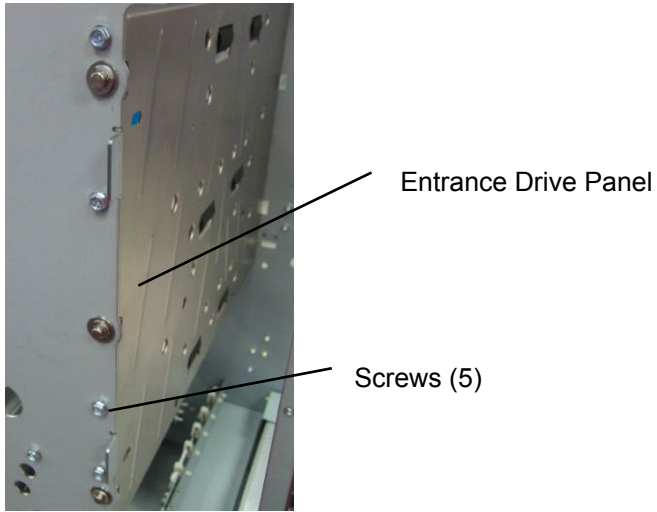

12. Remove the Screws (5) that hold the Entrance Drive Panel to the Rear Frame.

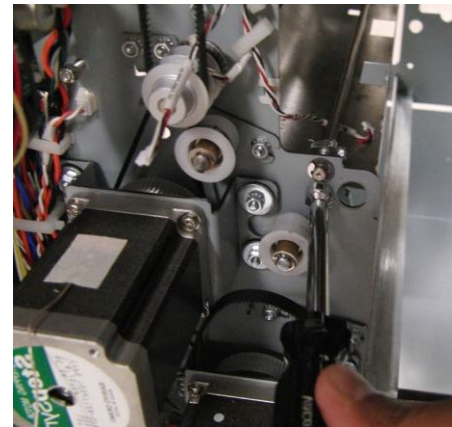
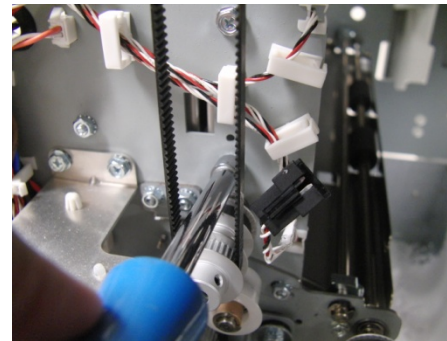
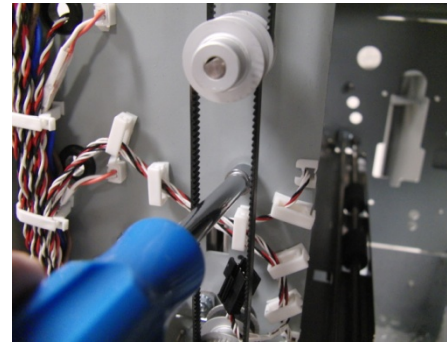
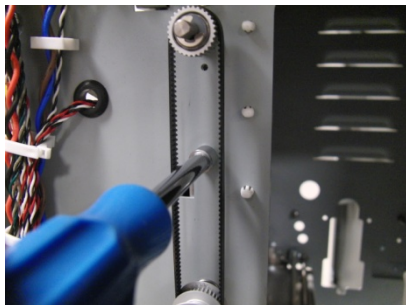
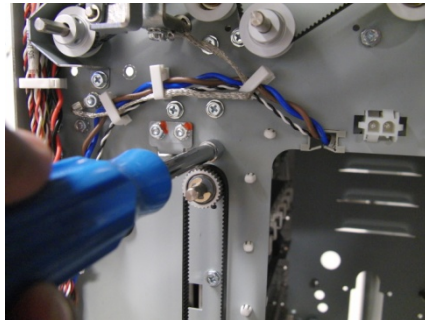

13. If you cannot remove the Entrance Drive Panel, do ARP 2.16 to remove the Idler Panel Mount Bracket (PL 2.1) from the lower position only.

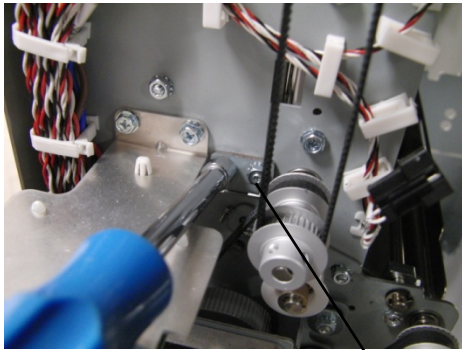

Idler Panel Mount Bracket

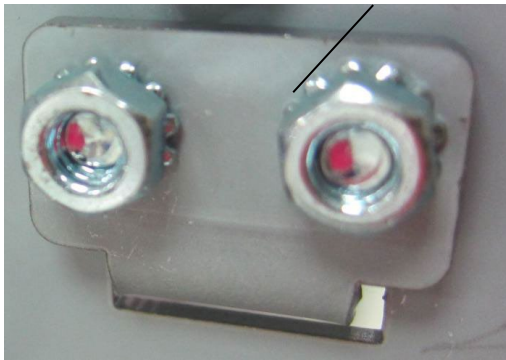

14. Remove the Entrance Drive Panel.
15. Transfer the sensor Boards and the Clear Cover Sensor to the new Panel Weldment.

Installation Procedure

Do the following to install the Entrance Drive Panel.

1. Place the Entrance Drive Panel in position.
2. Do ARP 2.16 to install the Idler Panel Mount Bracket (PL 2.1) at the lower position
3. Install the Screws (5) that hold the Entrance Drive Panel to the rear Frame.
4. Install the Screws (5) that hold the Entrance Drive Panel to the front Frame.
5. Connect the Sensor Board Connectors (2).
6. Place the Sensor Cables in the Cable Clamps and close the Cable Clamps.
7. Do ARP 2.26.1 to install the Drive Roller for Roller N5.
8. Hook the Acceleration Panel Latch Springs (2) to the Idler Panel side.
9. Do ARP 2.4 to install the Acceleration Idler Roller Panel.
10. Do ARP 2.3 to install the Entrance Idler Panel.
11. Do ARP 1.15 to install the Docking Bracket.
12. Do ARP 3.1 to install the Punch Module.
13. Do ADJ 1.8 Drive Panel Position Adjustment.
14. Do ARP 1.6 to install the Rear Cover.
15. Connect the Power Cord.

ARP 2.6 Lower Exit Panel Replacement

PARTS LIST ON PL 2.1

Use this procedure to remove and install the Lower Exit Panel.

Removal Procedure

WARNING

Do not perform Repair activities with the power on or electrical power supplied to the machine. Some machine components contain dangerous electrical voltages that can result in electrical shock and possible serious injury.

1. Disconnect the Power Cord.
2. Open the Front Door.
3. Remove the screw for ground strap.



4. Remove the E-clips (2) from the Shaft.

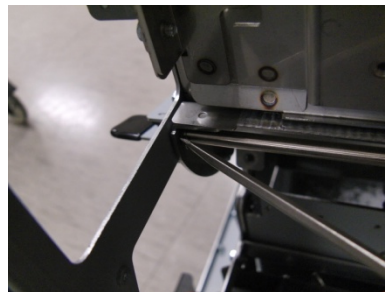
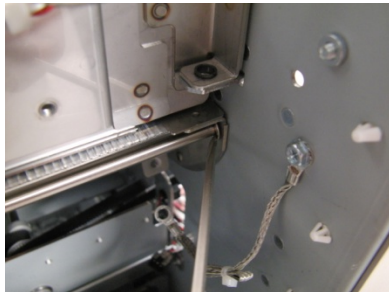

5. Slide the Shaft out of place.

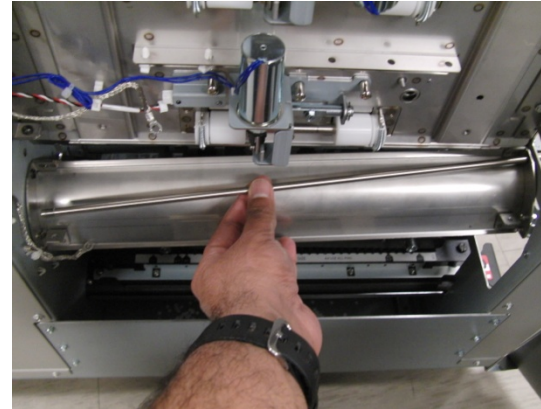

6. Remove the Lower Exit Panel.

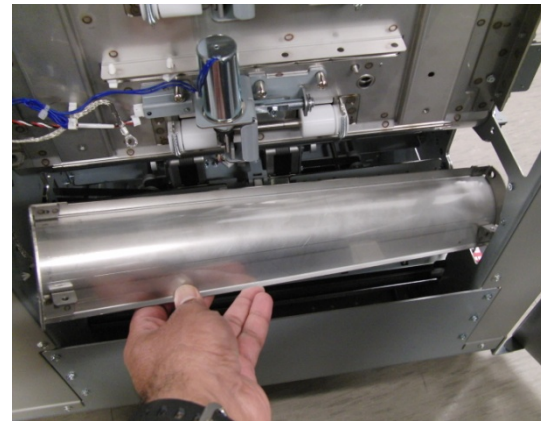

Installation Procedure

1. Place the Lower Exit Panel in position.
2. Slide the Shaft into place.
3. Install the E-clips (2) on the ends of the Shaft.
4. Close the Front Door.
5. Connect the Power Cord.

ARP 2.7 Exit Idler Panel Replacement

PARTS LIST ON PL 2.1, PL 3.4

Use this procedure to remove and install the Exit Idler Panel.

Removal Procedure

WARNING

Do not perform Repair activities with the power on or electrical power supplied to the machine. Some machine components contain dangerous electrical voltages that can result in electrical shock and possible serious injury.

1. Disconnect the Power Cord.
2. Open the Front Door.
3. Do GP 6.3 *Undock the Punch* to separate the Punch from the downstream devices.
4. Do ARP 1.18 to remove the Downstream side cover
5. Open the Cable Clamps to release all the sensor cables.

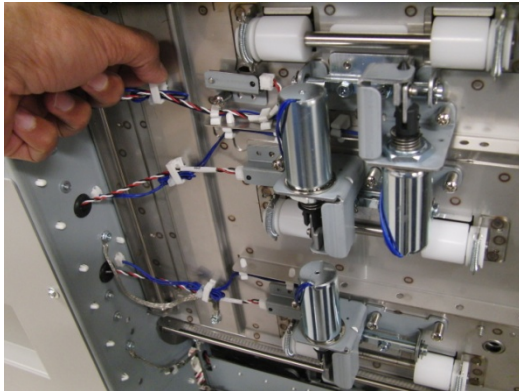

6. Disconnect the Connectors for Sensors S22, S23, & S24 at the sensor

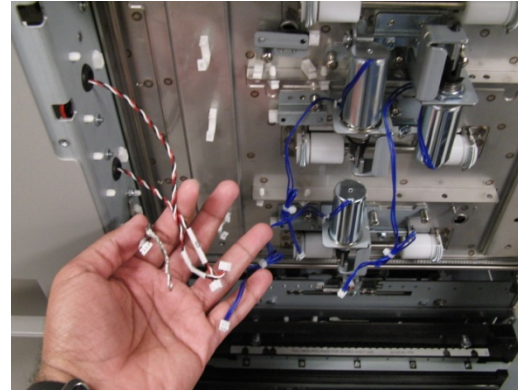

7. Disconnect the Connectors for Solenoids SOL6, SOL7, & SOL8 from the header at the rear frame.

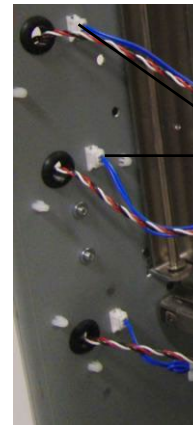

Solenoid SOL6,
SOL7 & SOL8
Connectors

(Cont.)

8. Remove the M4 screw for the ground strap.

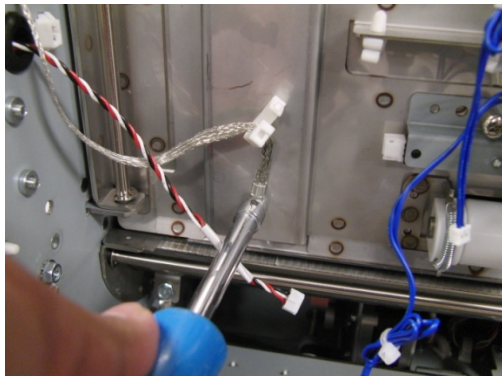

9. Remove the E-Ring from the bottom of the Idler Panel Shaft.

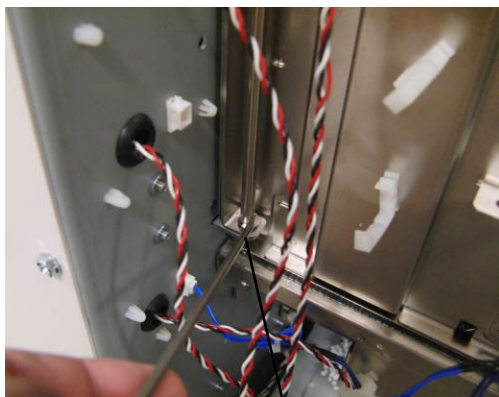

E-Ring

10. Remove the E-Ring from the top of the Idler Panel Shaft.



E-Ring

11. Open the Entrance Idler Panel from the front side.



12. Carefully remove the Shaft.



Shaft

13. Grasp and remove the Exit Idler Panel.

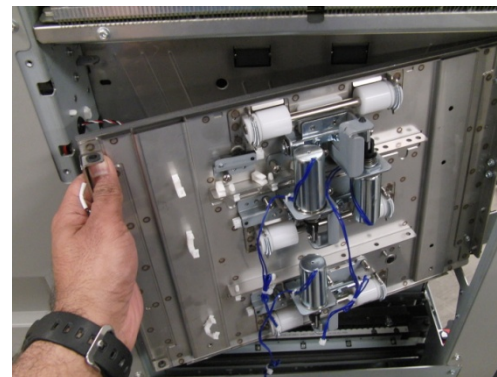

14. To replace the Exit Idler Panel Weldment do the following procedures to remove and install these components.

- ARP 2.15 Idler Roller Replacement
- ARP 2.28.2 Top, Middle, & Bottom Exit Sensor (S22, S23, S24) Replacement
- ARP 2.30.4 Exit Idler Solenoid Replacement
- ARP 2.6 Panel Close Magnet Replacement

Installation Procedure

1. Place the Exit Idler Panel in position.
2. Insert the Shaft through the holes (2) at the left side of the Exit Idler Panel.
3. Install the E-Rings (2) at the top and bottom of the Shaft.
4. Connect the Connectors for Solenoids SOL5, SOL6 & SOL7 to the header.
5. Connect the Connectors for Sensors S22, S23, & S24.
6. Place the sensor cables into the Cable Clamps, and close the Clamps
7. Install the ground strap
8. Do ARP 1.18 to install the Downstream side cover.
9. Do GP 6.4 *Dock the Punch* to connect the Punch to the downstream devices.
10. Close the Front Door.
11. Connect the Power Cord.

ARP 2.8 Drive Exit Panel Replacement

PARTS LIST ON PL 2.1

Use this procedure to remove and install the Drive Exit Panel.

Removal Procedure

WARNING

Do not perform Repair activities with the power on or electrical power supplied to the machine. Some machine components contain dangerous electrical voltages that can result in electrical shock and possible serious injury.

1. Disconnect the Power Cord.
2. Do GP 6.3 to undock the Punch from the upstream and downstream equipment.
3. Do ARP 1.18 Downstream side cover removal
4. Do ARP 2.6 to remove the Lower Exit Panel.
5. Do ARP 2.7 to remove the Exit Idler Panel.
6. Remove (3) M4 nuts to remove the Bracket in Area 5 of the machine.

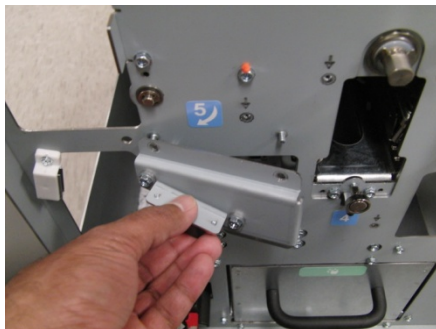
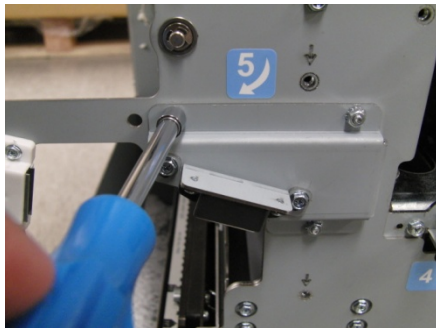

7. Do ARP 2.27 to remove Motor M7 by removing (4) screws.

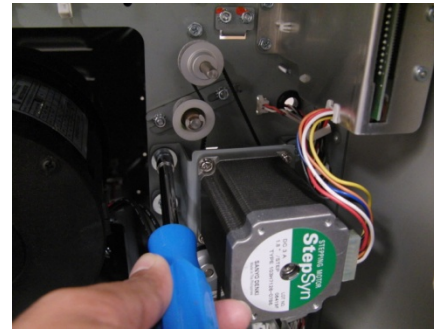

8. Remove the Timing Belt Tensioner Assembly of Motor M6 by removing (2) nuts.

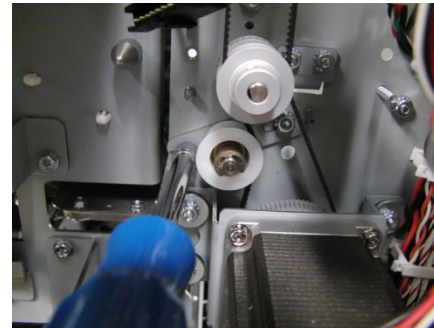

9. Remove (5) screws from the front frame that mount the Exit drive panel.

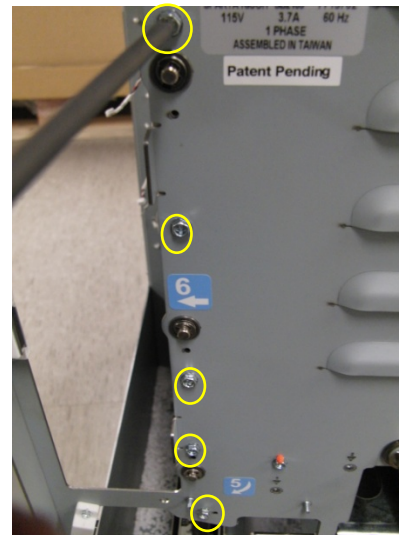

10. Remove (5) screws from the rear frame that mount the Exit drive panel.

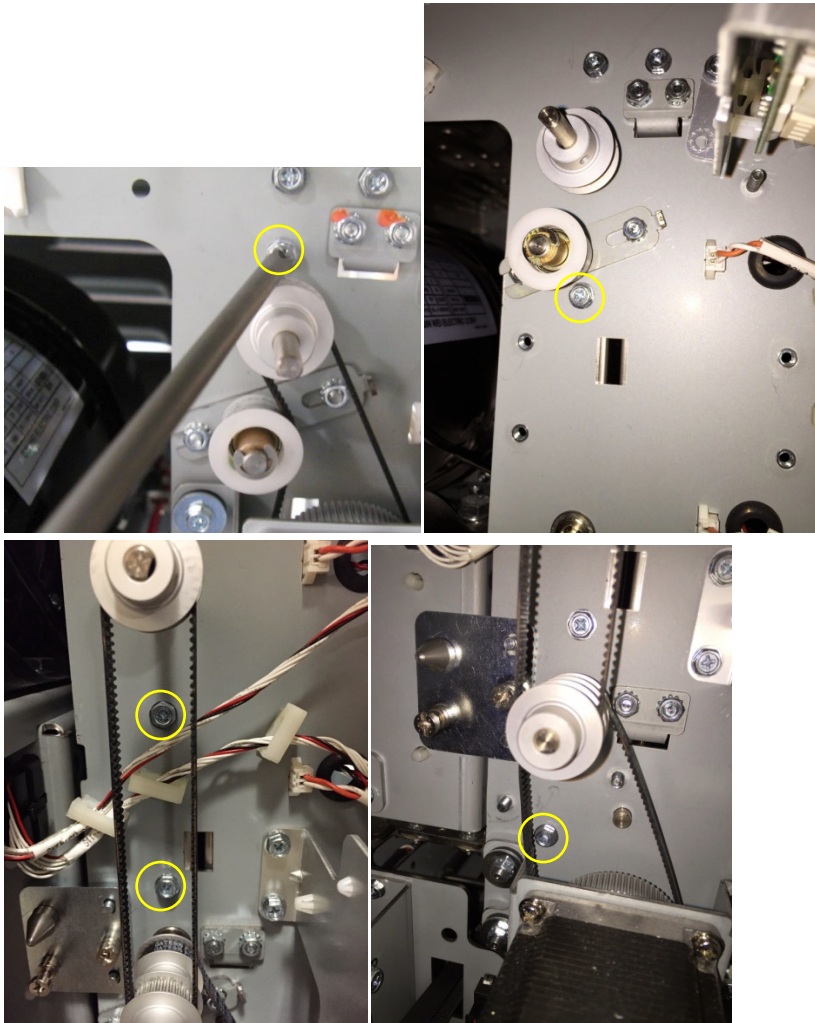

11. Remove the Drive Exit Panel.

Installation Procedure

1. Place the Drive Exit Panel in position.
2. Install the new Drive exit panel, by installing the (5) screws in the front frame and (5) screws in the rear frame.
3. Do ADJ 1.8 Drive Panel Position Adjustment
4. Place the Timing Belt Tensioner Assembly of Motor M6 in position and tighten the (2) nuts.
5. Do ARP 2.27 to install Motor M7.
6. Place the Bracket in position in Area 5 of the machine, and tighten the (3) M4 nuts.
7. Do ARP 2.7 to install the Exit Idler Panel.
8. Do ARP 2.6 to install the Lower Exit Panel.
9. Do ADJ 1.7 Idler Panel Magnetic Latches Adjustment.
10. Do ARP 1.18 Side cover removal. to install the downstream docking plate
11. Do GP 6.4 to dock the Punch to the upstream and downstream equipment.
12. Connect the Power Cord.

ARP 2.9 Punch Lower Exit Panel Replacement

PARTS LIST ON PL 2.1

Use this procedure to remove and install the Lower Exit Panel

Removal Procedure

1. Disconnect the Power Cord.
2. Do GP 6.3 to undock the Punch from the upstream and downstream equipment.
3. Do ARP 1.6 Rear Cover Replacement to remove the Rear Cover.
4. Do ARP 1.18 Downstream side cover removal
5. Do ARP 1.17 Drive roller cover removal to remove the downstream side roller cover.
6. Open the Upper bypass panel.
7. Remove the Screws (2) from the Front Frame used to mount the Lower Exit Panel.

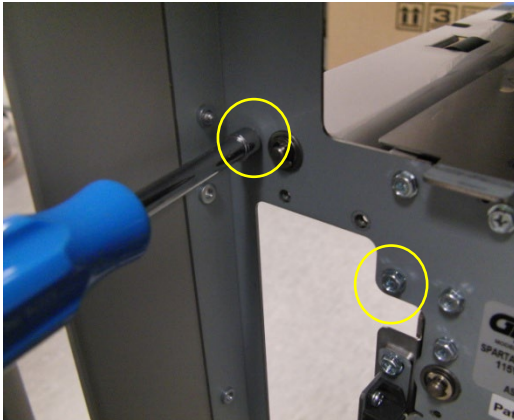

8. Remove the Screws (2) from the Rear Frame used to mount the Lower Exit Panel.

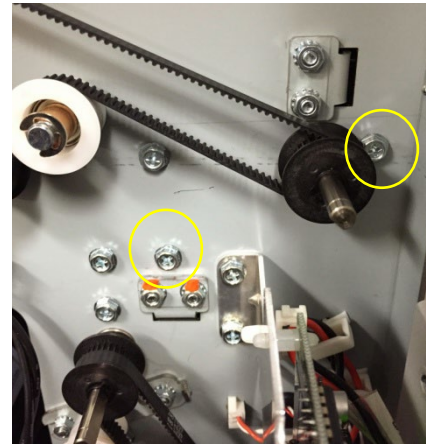

9. Remove the Lower Exit Panel.

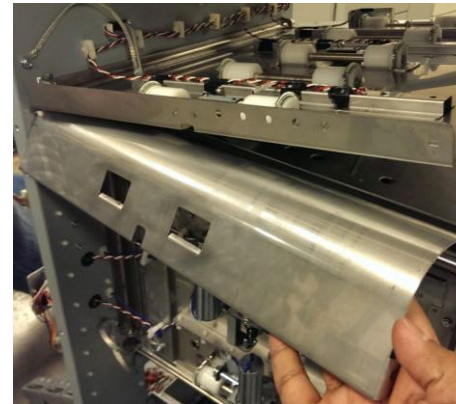

Installation Procedure

1. Place the Lower Exit Panel in position.
2. Tighten the Screws (4) used to mount the Inner Entrance Panel.
3. Do ARP 1.6 Rear Cover Replacement to install the Rear Cover.
4. Do ARP 1.18 to install Downstream side cover.
5. Do ARP 1.17 to install Drive roller cover.
6. Do GP 6.4 to dock the Punch to the upstream and downstream equipment.
7. Connect the Power Cord.
8. Do ADJ 1.2 Diverter Solenoid adjustment.

ARP 2.10 Inner Exit Panel Replacement

PARTS LIST ON PL 2.1

Use this procedure to remove and install the Inner Exit Panel.

Removal Procedure

WARNING

Do not perform Repair activities with the power on or electrical power supplied to the machine. Some machine components contain dangerous electrical voltages that can result in electrical shock and possible serious injury.

1. Disconnect the Power Cord.
2. Do GP 6.3 *Undock the Punch* to separate the Punch from the downstream devices.
3. Do ARP 1.6 to remove the Rear Cover.
4. Do ARP 1.18 Downstream side cover removal
5. Do ARP 2.9 to remove the Lower Exit Panel.
6. Remove (2) screws from the front frame and (2) screws from the rear frame that hold the Inner Exit Panel.

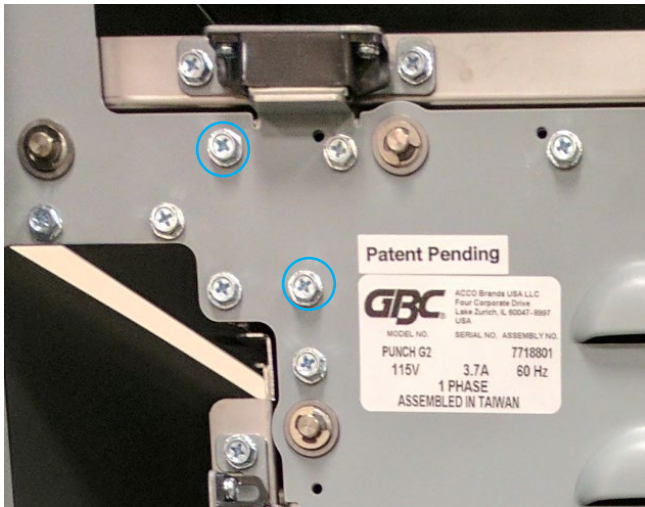

7. Remove the Inner Exit Panel.

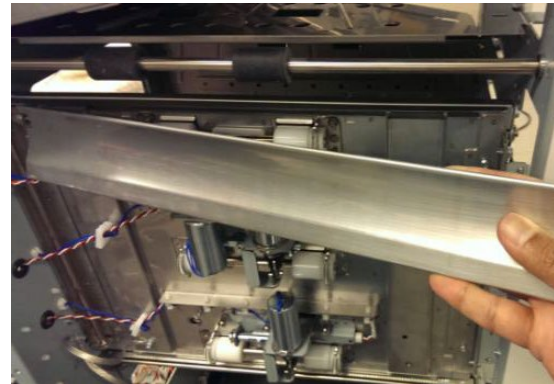

Installation Procedure

1. Place the Inner Exit Panel in position.
2. Tighten the (2) screws in the front frame and (2) screws in the rear frame that hold the Inner Exit Panel.
3. Do ARP 2.9 to install the Lower Exit Panel.
4. Do ARP 1.18 to install Downstream side cover
5. Do ARP 1.6 to install the Rear Cover.
6. Do GP 6.4 to dock the Punch to the downstream devices.
7. Connect the Power cord.

ARP 2.11 Upper Bypass Panel Replacement

PARTS LIST ON PL 2.1, PL 3.5

Use this procedure to remove and install the Upper Bypass Panel.

Removal Procedure

WARNING

Do not perform Repair activities with the power on or electrical power supplied to the machine. Some machine components contain dangerous electrical voltages that can result in electrical shock and possible serious injury.

1. Disconnect the Power Cord.
2. Do GP 6.3 to undock the Punch from the upstream and downstream equipment.
3. Do ARP 1.6 Rear Cover Replacement to remove the Rear Cover.
4. Unplug the Sensors from the Upper Bypass Panel and release the sensor cables from the cable clamps.

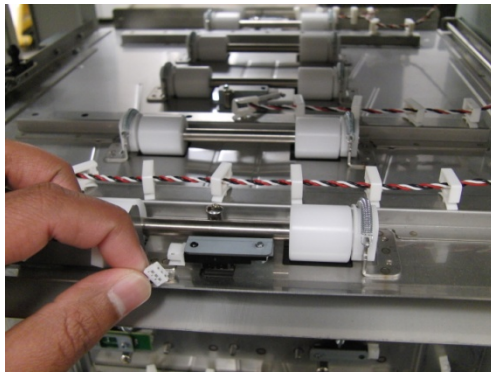

5. Remove the screw and nut for the ground strap.

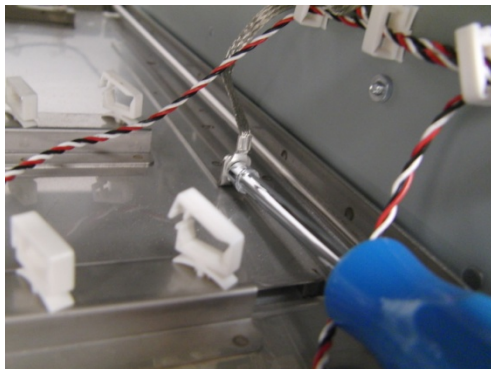

6. Remove (2) E-clips from the hinge shaft and remove the shaft.

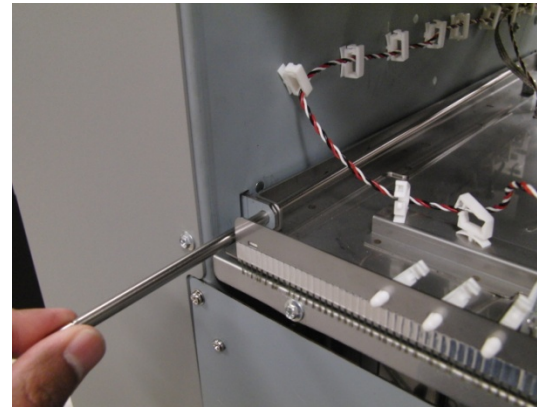
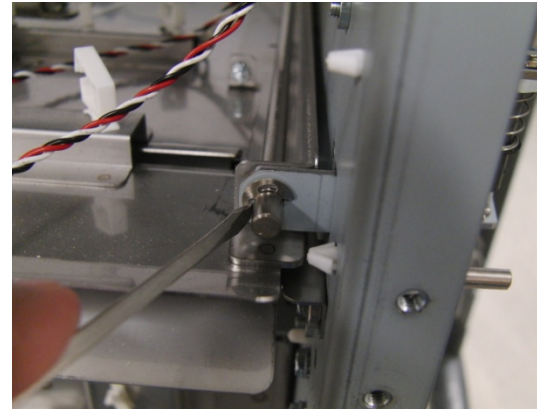

7. Remove (2) Idler panel magnetic latches from the Upper bypass assembly by unscrewing (4) screws.

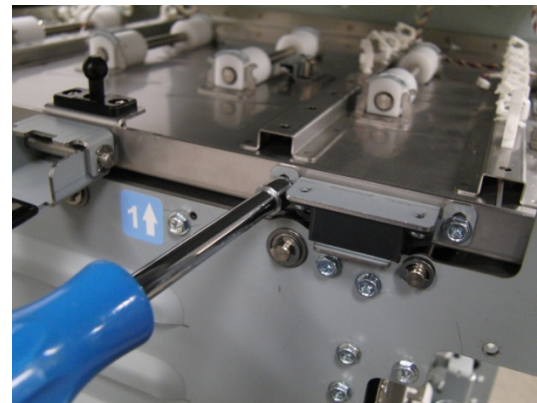

8. Remove the Handle assembly by removing (2) screws.

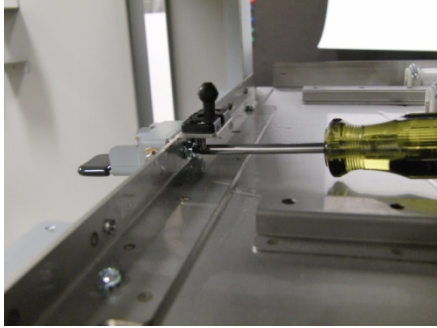

9. Remove the Idler Panel Mount Bracket from the rear frame.



10. Remove the Upper Bypass Assembly.

Installation Procedure

1. Transfer the Idler rollers, springs, sensors, Bypass Open sensor flag, Magnetic latches to the new part.
2. Place the Upper Bypass Assembly in position.
3. Install the the Handle Assembly.
4. Install the (2) Idler panel magnetic latches.
5. Install the Idler Panel Mount Brackets (2) on the rear frame.
6. Place the Shaft in position and install the (2) E-clips.
7. Connect the Sensors from the Upper Bypass Panel and place the sensor cables in the cable clamps.
8. Install the ground strap.
9. Do ARP 1.6 Rear Cover Replacement to install the Rear Cover.
10. Do GP 6.4 to dock the Punch to the upstream and downstream equipment.
11. Do ADJ 1.7 Idler Panel Magnetic Latches adjustment.
12. Connect the Power Cord.

ARP 2.12 Lower Bypass panel replacement

Use this procedure to remove and install the Upper Bypass Panel.

Removal Procedure

WARNING

Do not perform Repair activities with the power on or electrical power supplied to the machine. Some machine components contain dangerous electrical voltages that can result in electrical shock and possible serious injury.

1. Disconnect the Power Cord.
2. Do ARP 2.11 Upper bypass panel replacement to remove the Upper bypass panel.
3. Remove (4) M4 screws from the Front frame.



4. Remove (4) M4 screws from the Rear frame.

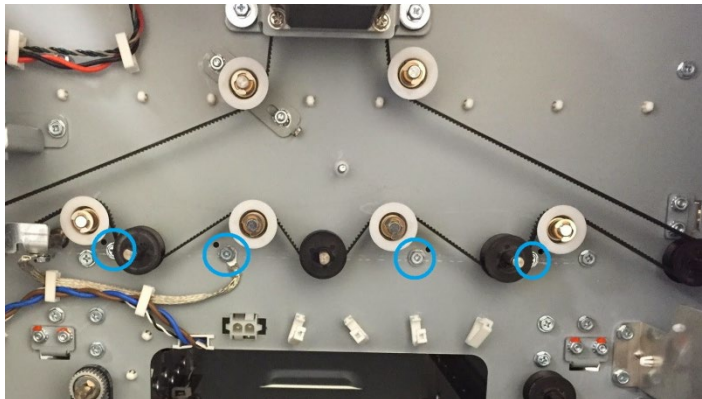

Installation Procedure

Reverse the Steps in the Removal procedure.

ARP 2.13 Bypass Diverter Replacement

PARTS LIST ON PL 2.5

Use this procedure to remove and install the Bypass Diverter Assembly.

Removal Procedure

1. Disconnect the Power Cord.
2. Do ARP 1.6 to remove the Rear Cover.
3. Remove the E-clip from the Diverter Shaft on the front side.



4. Remove the M4 screws (2) from the Diverter Shaft on the rear side.

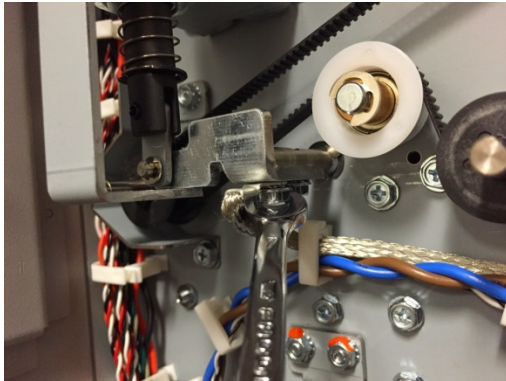

5. Remove the E-clip from the Diverter Shaft on the rear side.



6. Slide the Diverter Assembly to the back side and remove the part.



Installation Procedure

1. Slide the Diverter Assembly into position through to the rear side.
2. Install the E-clip on the Diverter Shaft at the rear side.
3. Install the M4 screws (2) on the Diverter Shaft at the rear side.
4. Install the E-clip on the Diverter Shaft at the front side.
5. Do ARP 1.6 to install the Rear Cover.
6. Connect the Power Cord.
7. Do ADJ 1.2 Diverter Solenoid Adjustment.

ARP 2.14 Panel Close Magnet Replacement

PARTS LIST ON PL 2.2

Use this procedure to remove and install the Magnet and Magnet Bracket for the Entrance Idler Panel, the Exit Idler Panel, or the Upper Bypass Panel.

WARNING

Do not perform Repair activities with the power on or electrical power supplied to the machine. Some machine components contain dangerous electrical voltages that can result in electrical shock and possible serious injury.

1. Disconnect the Power Cord.
2. Remove the Screws (2) and Nuts (2).
3. Remove the Magnet Bracket.
4. Remove the old Magnet.

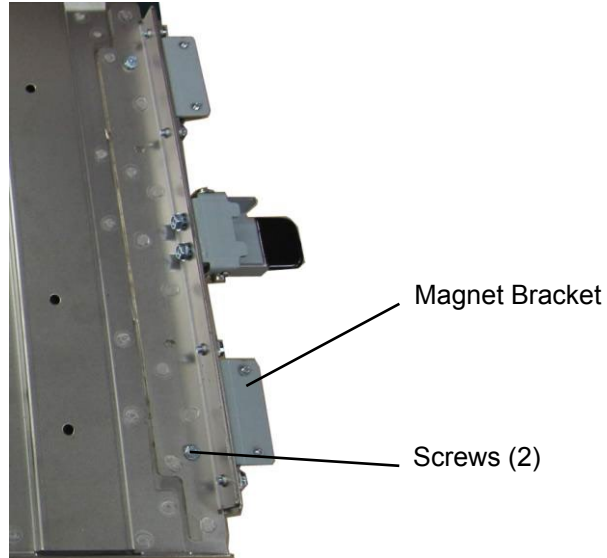

5. Place the Magnet Bracket in position and insert the Screws.

6. Do ADJ 1.7 Idler Panel Magnetic Latches Adjustment.



7. Connect the Power Cord.

ARP 2.15 Idler Roller Replacement

PARTS LIST ON PL 3.2, PL 3.3, PL 3.4, PL 3.5

Use this procedure to remove and install the Idler Rollers or the Retaining Springs in these assemblies:

- Entrance Idler Panel.
- Acceleration Roller Idler Assy.
- Exit Idler Panel.
- Bypass Panel

Removal Procedure

WARNING

Do not perform Repair activities with the power on or electrical power supplied to the machine. Some machine components contain dangerous electrical voltages that can result in electrical shock and possible serious injury.

1. Disconnect the Power Cord.
2. Do the following to access the Idler Rollers.
 - For the Idler Rollers in the Entrance Idler Panel, Acceleration Roller panel, Exit Idler panel, undock the punch from upstream and downstream devices, GP 6.3
 - For the Idler Rollers in the Bypass Panel, Open the Front Door.

3. Lift the Extension Spring (2) up off the Bearing Housing (2) at each end of the Idler Roller Shaft.

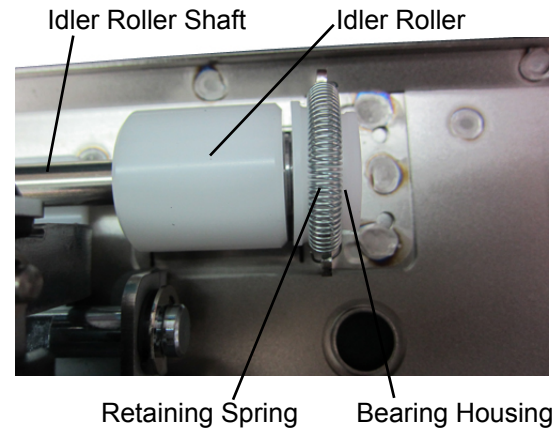

4. Remove the Idler Roller with the Bearing Housings (2) from the Bushing Forks.



5. Remove the Bearing Housing (2) at each end of the Idler Roller Shaft.



(Cont.)

Installation Procedure

1. Place the Bearing Housings (2) on the ends of the Idler Roller Shaft.
2. Place the new Idler Roller with the Bearing Housings (2) into the Bushing Forks.



3. Make sure the flat surface of the bushing aligns in the fork.
4. Rollers are non-directional so it does not matter which end goes in each fork.
5. After the assembly is in place, gently pull the assembly outward and release to ensure it moves freely in the fork.
6. Place the Extension Spring (2) over the Bearing Housings (2).
7. Place the hooks on the ends of the Extension Springs (2) on the notches at the top of the Bushing Forks (2).
8. Connect the Power Cord.

ARP 2.16 Idler Panel Mount Bracket Replacement PARTS LIST ON PL 2.1

Use this procedure to remove and install the Idler Panel Mount Bracket.

Removal Procedure

1. Disconnect the Power Cord.
2. Do ARP 1.6 to remove the Rear Cover.
3. There are 6 Idler Panel Mount Brackets in the machine (2 of them are non-replaceable and marked with orange lacquer). Locate the appropriate Idler Panel Mount Bracket.

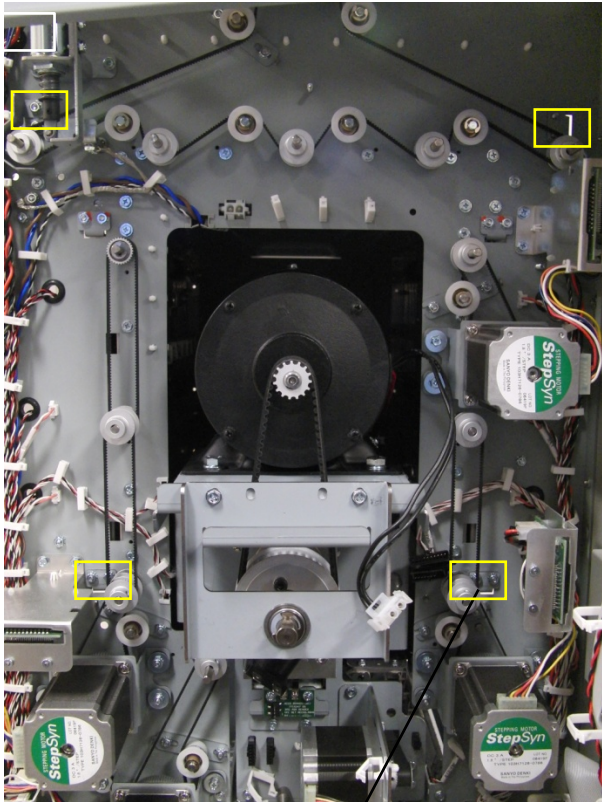

Idler Panel Mount Bracket

NOTE: To remove the Entrance Drive Panel (ARP 2.1), you must only remove the lower Idler Panel Mount Bracket.)

4. Remove the Nuts (2) and the Idler Panel Mount Bracket.

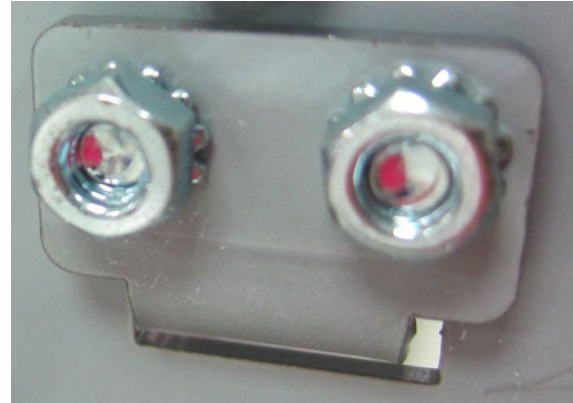

Installation Procedure

1. Place the Idler Panel Mount Bracket in position and tighten the Nuts (2).
2. Do ARP 1.6 to install the Rear Cover.
3. Connect the Power Cord.

ARP 2.17 Flange Ball Bearing Replacement

PARTS LIST ON PL 2.4

Use this procedure to remove and install a Flange Ball Bearing Part # 1821116 or 7706532).

1. Disconnect the Power Cord.
2. Locate the Flange Ball Bearing.

Front side

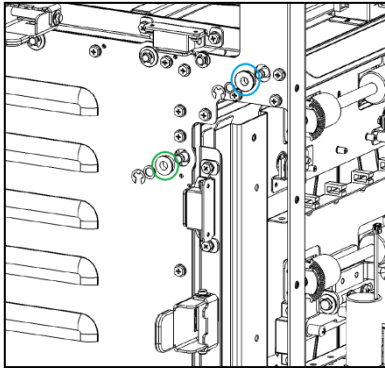

Rear side

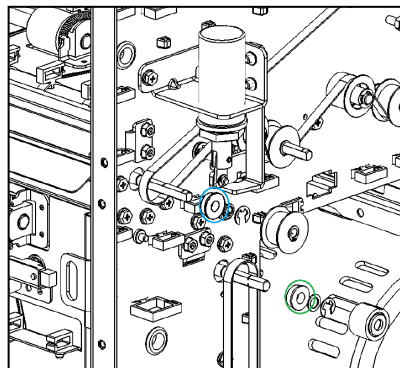

- There are 22 Flange Ball Bearings (Pt # 1821116) on the Frame (PL 2.4).- shown in blue color
 - There are 2 Flange Ball Bearings (Pt # 7706532) on the Frame (PL 2.4).- shown in green color
3. Remove the E-Ring.
 4. Remove the Flat Washer.
 5. Remove the Flange Ball Bearing.

NOTE: To Replace a Bearing from the rear side, do ARP 2.24 to remove the Pulley.

6. Place the new Flange Ball Bearing in position.
7. Install the Flat Washer.
8. Install the E-Ring.
9. Connect the Power Cord.

ARP 2.18 Snap-in Bearing Replacement

PARTS LIST ON PL 2.2, 2.3, 3.2, 3.3, 3.5, 3.4

Use this procedure to remove and install a Snap-in Bearing, located in one of the following assemblies.

- Entrance Idler Panel (PL 3.2)
- Acceleration Roller Idler Assembly (PL 3.3)
- Upper Bypass Panel (PL 3.5)
- Exit Idler Panel (PL 3.4)
- Lower Exit Panel (PL 2.2)

WARNING

Do not perform Repair activities with the power on or electrical power supplied to the machine. Some machine components contain dangerous electrical voltages that can result in electrical shock and possible serious injury.

1. Disconnect the Power Cord.
2. Do one of the following to remove the panel so you can access the Snap-in Bearing.
 - ARP 2.3 Entrance Idler Panel Replacement
 - ARP 2.5 Acceleration Roller Idler Assembly Replacement
 - ARP 2.7 Upper Bypass Panel Replacement
 - ARP 2.9 Exit Idler Panel Replacement
 - ARP 2.13 Lower Exit Panel Replacement

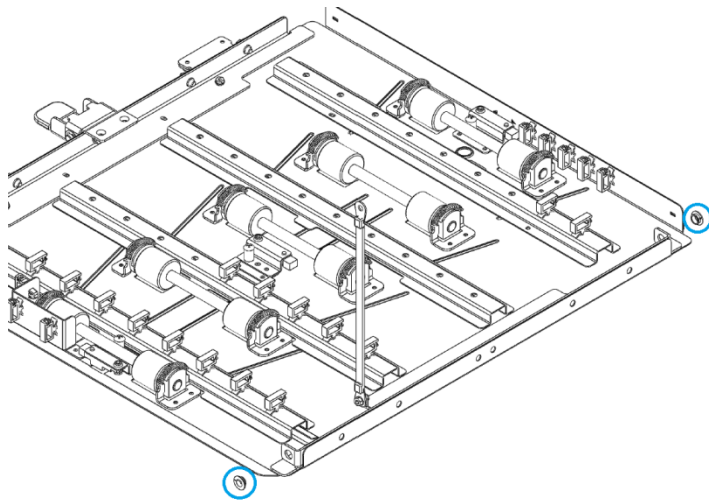

3. Remove the Snap-in Bearing.
4. Place the new Snap-in Bearing in position.
5. Do one of the following to install the panel.
 - ARP 2.3 Entrance Idler Panel Replacement
 - ARP 2.5 Acceleration Roller Idler Assembly Replacement
 - ARP 2.7 Upper Bypass Panel Replacement
 - ARP 2.9 Exit Idler Panel Replacement
 - ARP 2.13 Lower Exit Panel Replacement
6. Connect the Power Cord.
7. Press the Power Switch to the on position.

ARP 2.19 Bearing Housing Replacement

PARTS LIST ON PL 3.2, PL 3.3, PL 3.4, PL 3.5

Use this procedure to remove and install the Bearing Housings for the Idler Rollers in these assemblies:

- Entrance Idler Panel.
 - Acceleration Roller Idler Assy.
 - Exit Idler Panel.
 - Bypass Panel
1. Do ARP 2.15 to remove the Idler Roller with the Bearing Housings (2) from the Bushing Forks.

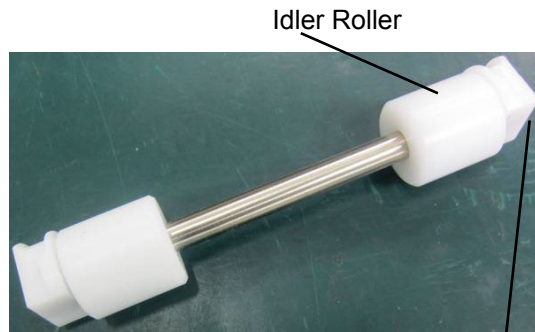

2. Remove the old Bearing Housings (2) from the ends of the Shaft.



3. Place the new Bearing Housings (2) on the ends of the Shaft with the flange of the Bearing facing in toward the Idler Roller.

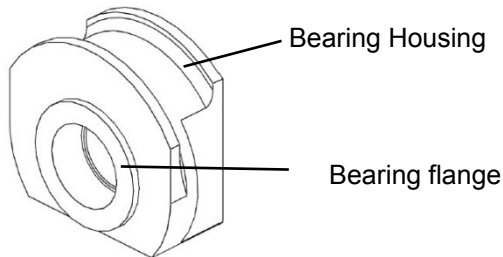

4. Do ARP 2.15 to install the Idler Roller.

ARP 2.20 Accel Idler Latch Handle Replacement

PARTS LIST ON PL 2.2

Use this procedure to remove and install the Accel Idler Latch Handle or the Accel Idler Shaft.

Removal Procedure

WARNING

Do not perform Repair activities with the power on or electrical power supplied to the machine. Some machine components contain dangerous electrical voltages that can result in electrical shock and possible serious injury.

1. Disconnect the Power Cord.
2. Open the Front Door.
3. Remove (2) screws from the Accel Idler Latch Handle.

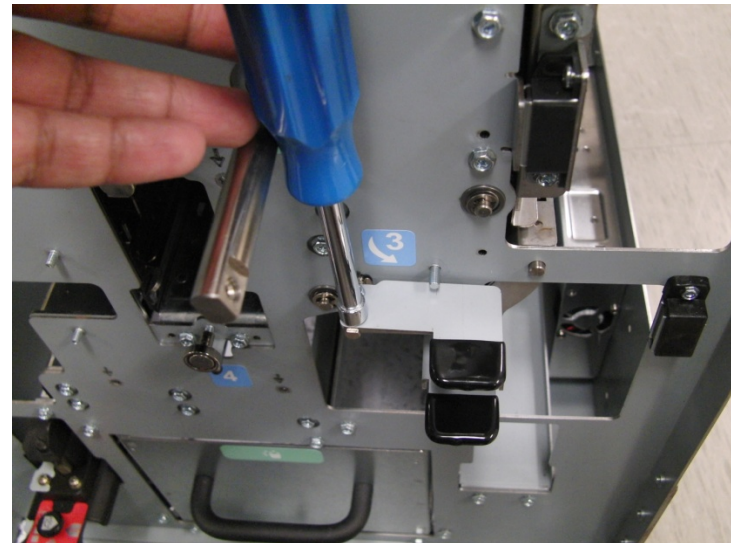

4. Remove the Rubber Cap and transfer it to the new part, if re-using the rubber cap. If a new Rubber cap has been ordered, use the new part.



Installation Procedure

1. Place the Accel Idler Latch Handle in position and tighten the Screws (2).
2. Close the Front Door.
3. Connect the Power Cord.

ARP 2.21 Accel Idler Latch Shaft, Rear Latch and Front Latch Assembly Replacement

PARTS LIST ON PL 2.5

Use this procedure to remove and install one or more of the following:

- Accel Idler Latch Shaft
- Accel Idler Panel Rear Latch Assembly
- Accel Idler Panel Front Latch Assembly

Removal Procedure

1. Disconnect the Power Cord.
2. Do ARP 1.6 to remove the Rear Cover.
3. Do ARP 3.1.1 to remove the Punch Module.
4. Unhook the Extension Springs from the Accel Idler Panel Front and Rear Latches.

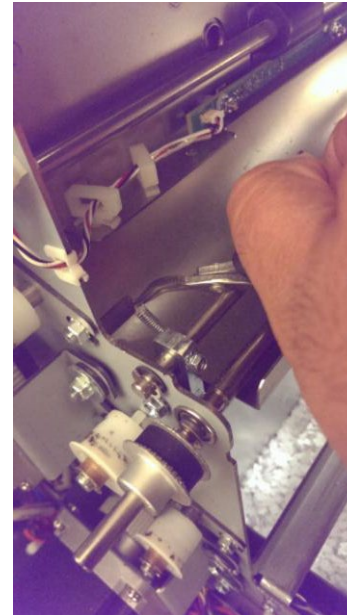

5. Remove the M3 screws (2) from the Accel Idler Panel Front and Rear Latches.

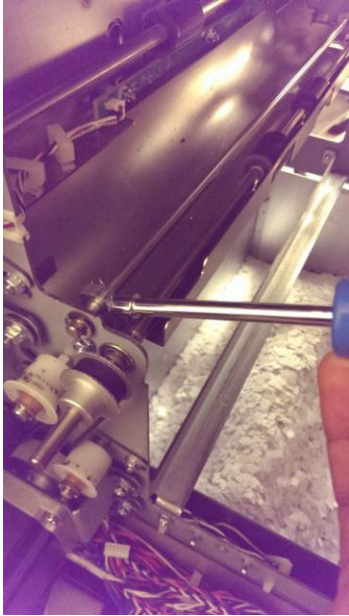

6. Remove the E-clip from the Accel Idler Shaft on the rear side.



7. Do ARP 2.20 to remove the Accel Idler Latch Handle.
8. Remove the E-clip from the Accel Idler Shaft on the front side.

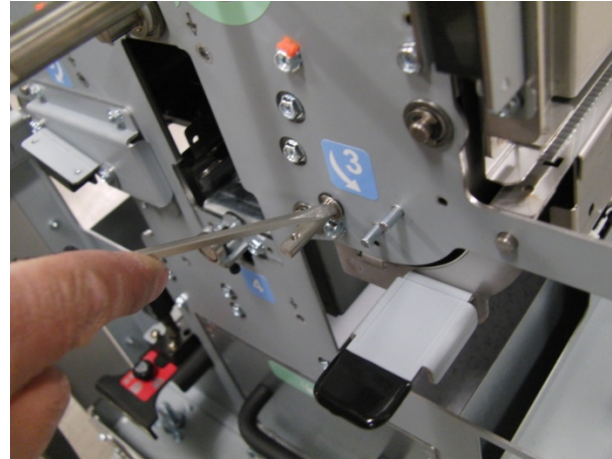

9. For the Accel Idler Panel Rear Latch Assembly, slide the shaft towards the front side to remove.



10. For the Accel Idler Panel Front Latch Assembly, slide the shaft towards the rear side to remove.

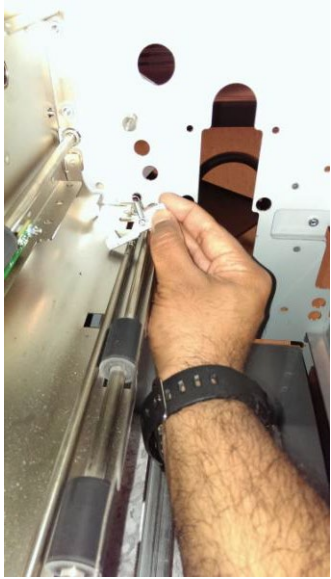

11. Remove Accel Panel Rear and Front Latch assemblies to remove the Accel Idler Latch shaft.



Installation Procedure

1. Place the Accel Panel Rear and Front Latch Assemblies in position to install the Accel Idler Latch Shaft.
2. For the Accel Idler Panel Front Latch Assembly, slide the shaft towards the front side to install.
3. For the Accel Idler Panel Rear Latch Assembly, slide the shaft towards the rear side to install.
4. Install the E-clip on the Accel Idler Shaft from the front side.
5. Do ARP 2.20 to install the Accel Idler Latch Handle.
6. Install the E-clip on the Accel Idler Shaft from the rear side.
7. Install the M3 screws (2) in the Accel Idler Panel Front and Rear Latches.
8. Hook the Extension Springs to the Accel Idler Panel Front and Rear Latches.
9. Do ARP 3.1.2 to install the Punch Module.
10. Do ARP 1.6 to install the Rear Cover.
11. Connect the Power Cord.

ARP 2.22 One Way Clutch and Pulley Sub-Assembly Replacement PARTS LIST ON PL 2.4

Use this procedure to remove and install the One Way Clutch and Pulley Sub-Assembly.

WARNING

Do not perform Repair activities with the power on or electrical power supplied to the machine. Some machine components contain dangerous electrical voltages that can result in electrical shock and possible serious injury.

1. Disconnect the Power Cord.
2. Remove the E-Clip and Washer.
3. Slide the old One Way Clutch Assembly off the Shaft, while leaving the Timing Belt in place.

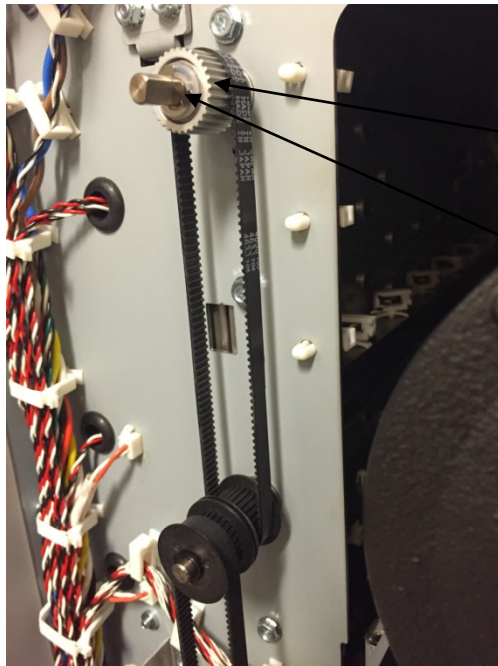

One Way Clutch

E-Clip and Washer

4. Place the new One Way Clutch Assembly on to the Shaft.
5. Install the Washer and the E-Clip.
6. Connect the Power Cord.

ARP 2.23 Drive Idler Roller Assembly Replacement PARTS LIST ON PL 2.3

Use this procedure to remove and install a one way Drive Idler Roller Assembly.

Removal Procedure

WARNING

Do not perform Repair activities with the power on or electrical power supplied to the machine. Some machine components contain dangerous electrical voltages that can result in electrical shock and possible serious injury.

1. Disconnect the Power Cord.
2. Do ARP 2.25.1 to remove the 534T Belt
3. Remove the E-ring and the Spacer.
4. Slide out the old Idler Roller from the Stud.

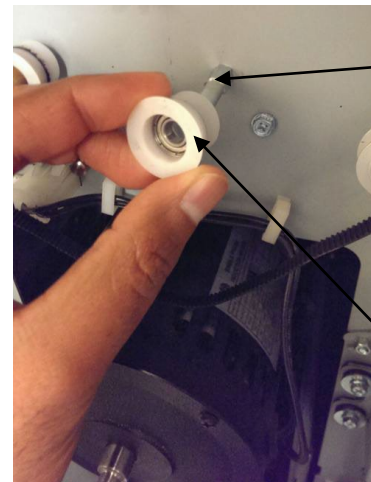

Stud

Idler Roller

5. Place the new Idler Roller on the Stud.
6. Install the Spacer and the E-ring.
7. Do ARP 2.25.1 to install the 534T Belt
8. Connect the Power Cord.

ARP 2.24 Timing Pulley Replacement PARTS LIST ON PL 2.9

Use this procedure to remove and install the Timing Pulley.

Removal Procedure

WARNING

Do not perform Repair activities with the power on or electrical power supplied to the machine. Some machine components contain dangerous electrical voltages that can result in electrical shock and possible serious injury.

1. Disconnect the Power Cord.
2. Do ARP 1.6 to remove the Rear Cover.
3. Do ARP 2.25 to remove the appropriate Timing Belt from the Pulley.
4. Remove the retaining ring from the roller shaft.



5. Remove the Timing Pulley by sliding it out.



6. Place the Timing Pulley in position on the Shaft and install the retaining ring.
7. Do ARP 2.25 to install the appropriate Timing Belt.
8. Do ADJ 1.4 Timing belt adjustment for the appropriate belt tension adjustment.
9. Do ARP 1.6 to install the Rear Cover.
10. Connect the Power Cord.

ARP 2.25 Timing Belt Replacement

There are eight (8) belts used at the rear of the Frame in the PUNCH G2.

Fie (5) belts connect to motors.

Type of Belt	#	Motor	ARP	Page
Belt, 534T, 2MM 2GT	1 belt	M8	ARP 2.25.1	4-52
Belt, 134T, 2MM 2GT	3 belts	M1 M6 M7	ARP 2.25.2	4-53
Belt, 179T, 2MM 2GT, 6MM Wide	1 belt	M2	ARP 2.25.4	4-54

Three (3) belts are used to connect two nip rollers.

Type of Belt	#	Connects Rollers	ARP	Page
Belt, 150 T, 2MM 2GT	3 belts	N1 and N2 N2 and N3 N8 and N9	ARP 2.25.3	4-54

Use the following procedures to Replace the belts.

ARP 2.25.1 534T Belt Replacement

PARTS LIST ON PL 2.9

Use this procedure to remove and install the 534T Belt for the Bypass Motor (M8).

WARNING

Do not perform Repair activities with the power on or electrical power supplied to the machine. Some machine components contain dangerous electrical voltages that can result in electrical shock and possible serious injury.

1. Disconnect the Power Cord.
2. Do ARP 1.6 to remove the Rear Cover.
3. Loosen the Tensioner and remove the old Belt.



Tensioner

4. Place the new Belt in position around the Pulleys (11).

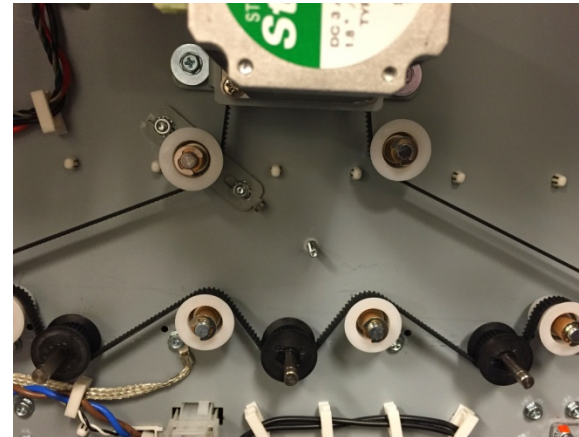

(Cont.)

5. Adjust the Belt Tension per ADJ 1.4 Timing Belt Adjustment.

6. Do ARP 1.6 to install the Rear Cover.
7. Connect the Power Cord.

ARP 2.25.2 **134T Belt Replacement**

PARTS LIST ON PL 2.9

Use this procedure to remove and install the 134T Belt.

WARNING

Do not perform Repair activities with the power on or electrical power supplied to the machine. Some machine components contain dangerous electrical voltages that can result in electrical shock and possible serious injury.

1. Disconnect the Power Cord.
2. Do ARP 1.6 to remove the Rear Cover.
3. Loosen the Tensioner and remove the old Belt.



4. Place the new Belt in position around the Pulleys.
5. Adjust the Belt Tension per ADJ 1.4 Timing Belt Adjustment.
6. Do ARP 1.6 to install the Rear Cover.
7. Connect the Power Cord.

ARP 2.25.3 150T Belt Replacement

PARTS LIST ON PL 2.9

Use this procedure to remove and install the 150T Belt.

Removal Procedure

WARNING

Do not perform Repair activities with the power on or electrical power supplied to the machine. Some machine components contain dangerous electrical voltages that can result in electrical shock and possible serious injury.

1. Disconnect the Power Cord.
2. Do ARP 1.6 to remove the Rear Cover.
3. Do ARP 2.24 to remove both of the Pulleys Connected to the Belt that is being replaced.

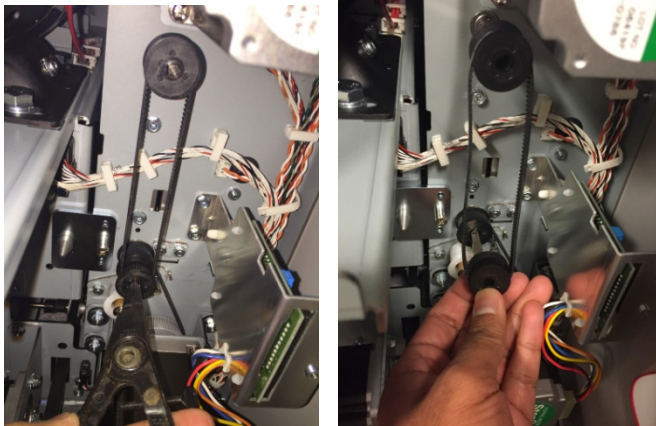

4. Place the Belt in position between the Pulleys and slide the Pulleys on to the Shafts.
5. Install the retaining rings
6. Do ARP 1.6 to install the Rear Cover.
7. Connect the Power Cord.

ARP 2.25.4 179T Belt Replacement

PARTS LIST ON PL 2.9

Use this procedure to remove and install the Belt 179T, 2MM 2GT, 6MM Wide.

WARNING

Do not perform Repair activities with the power on or electrical power supplied to the machine. Some machine components contain dangerous electrical voltages that can result in electrical shock and possible serious injury.

1. Disconnect the Power Cord.
2. Do ARP 1.6 to remove the Rear Cover.
3. Loosen the Tensioner and remove the old Belt.



4. Place the new Belt in position around the Pulleys.
5. Adjust the Belt Tension per ADJ 1.4 Timing Belt Adjustment.
6. Do ARP 1.6 to install the Rear Cover.
7. Connect the Power Cord.

ARP 2.26 Drive Roller Assembly Replacement

PARTS LIST ON PL 2.2, PL 2.3, PL 2.4

Use this procedure to remove and install a Drive Roller Assembly (Part # 7715093) used in Nips N1 - N14, except Nip N5.

Do not use this procedure for Nip N5 (Part # 7715097), Do ARP 2.26.1.

Procedures for individual Drive Rollers are located immediately after this general procedure.

Removal Procedure

1. Do ARP 1.6 to remove the Rear Cover.
2. Open the Front Door.
3. Locate the appropriate Drive Roller.

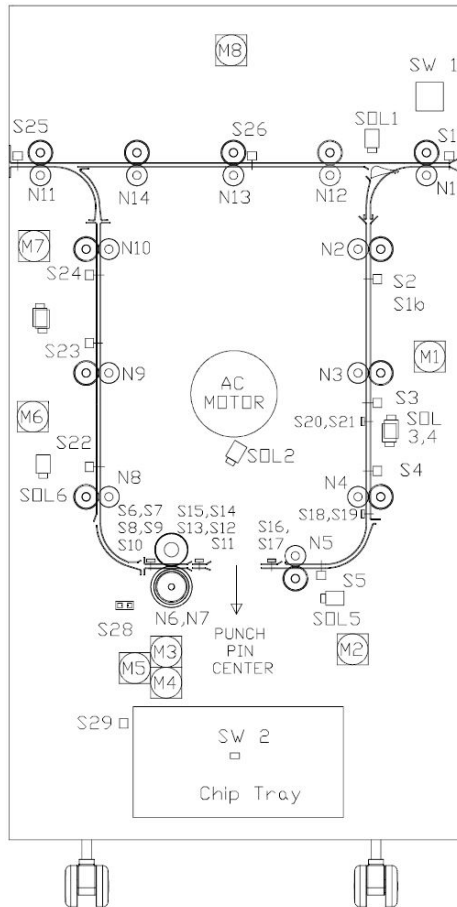

4. For all Drive Rollers (except N1 and N11), do ARP 3.1 to remove the Punch Module.
5. Do ARP 2.25 to remove the Belt from the appropriate Drive Roller Shaft.
6. Do ARP 2.24 to remove the Pulley from the appropriate Drive Roller Shaft.
7. Remove the E-Ring and the Washer from the end of the Drive Roller Shaft at the front of the machine.

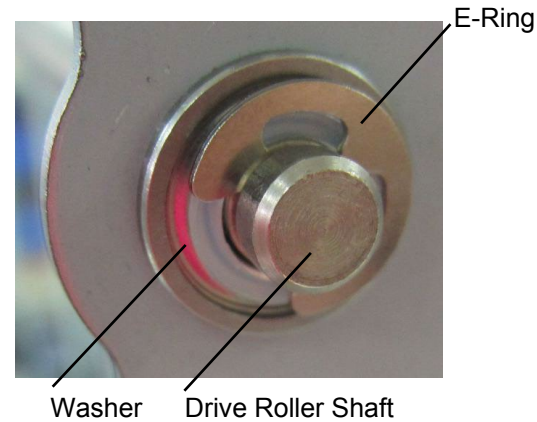

(Cont.)

8. Remove the E-Ring and the Washer from the end of the Drive Roller Shaft at the rear of the machine.

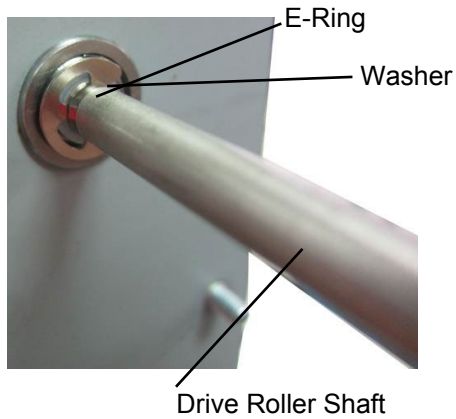

9. Remove the Drive Roller.



10. Remove the Bearing from the front of the machine.
11. Remove the Bearing from the rear of the machine.

Installation Procedure

1. Place the Drive Roller in position
2. Place the Bearing in position at the front of the machine.
3. Place the Bearing in position at the rear of the machine.
4. Place the Washer and the E-Ring in position the end of the Drive Roller Shaft at the front of the machine.
5. Place the Washer and the E-Ring in position the end of the Drive Roller Shaft at the rear of the machine.
6. Do ARP 2.24 to install the Pulley on the appropriate Drive Roller Shaft.
7. Do ARP 2.25 to install the Belt on the appropriate Drive Roller.
8. For all Drive Rollers (except N1 and N11), do ARP 3.1 to install the Punch Module.
9. Do ARP 1.6 to install the Rear Cover.
10. Close the Front Door.
11. Connect the Power Cord.

ARP 2.26.1 Drive Roller N5 Replacement

Do the following to remove and replace the Drive Roller for Nip N5.

Removal Procedure

1. Disconnect the Power Cord.
2. Do ARP 1.6 to remove the Rear Cover.
3. Do ARP 3.1 to remove the Punch Module.
4. Loosen the nuts (2) on the Tensioner of the M2 motor belt.

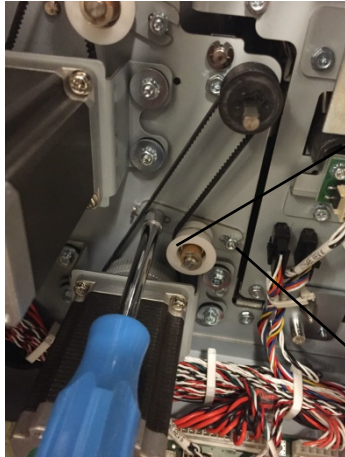

Tensioner

Nuts (2)

5. Remove the retaining ring from the shaft of roller N5.



6. Remove the Belt from the Motor Pulley

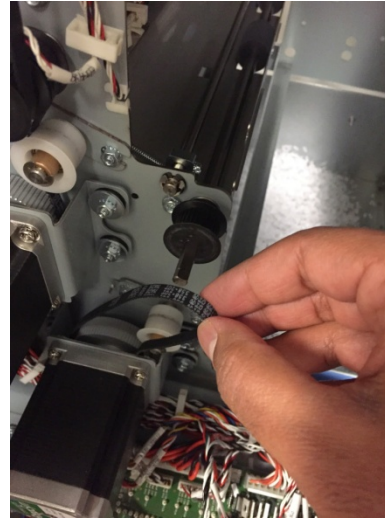

7. Slide the Pulley off the Roller Shaft.



(Cont.)

8. Remove the E-Ring and the Washer from the rear side of the Shaft.

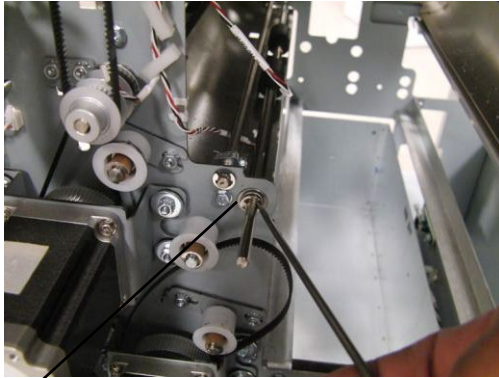

E-Ring and Washer

9. Remove the E-Ring at the front side of the Shaft.



E-Ring

10. Remove the Washer and Ball Bearing from the front side.

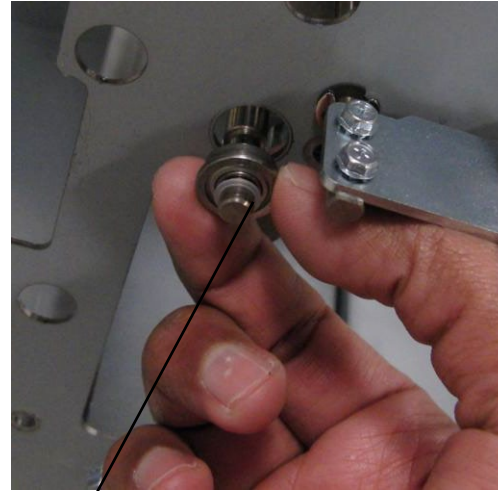

Washer and Ball Bearing

11. Remove the Ball Bearing from the rear side of the Shaft.

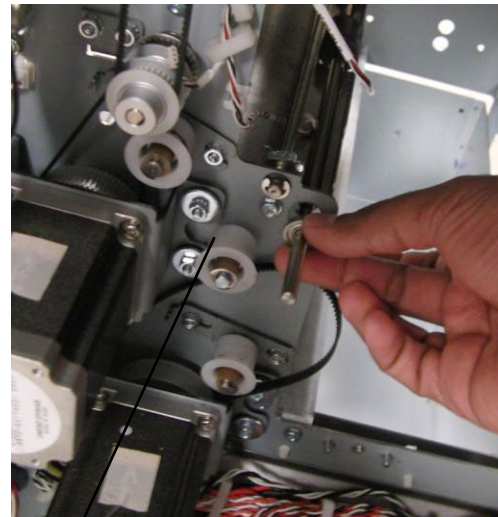

Ball Bearing

(Cont.)

12. Remove the Drive Roller.

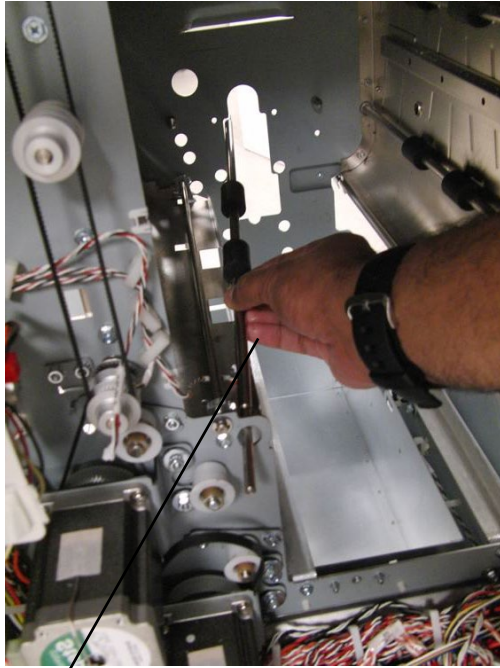

Drive Roller.

Installation Procedure

1. Place the Drive Roller in position.
2. Install the Ball Bearing at the rear side of the Shaft.
3. Install the Ball Bearing and the Washer at the front side of the Shaft.
4. Install the E-Ring at the front side of the Shaft
5. Install the Washer and the E-Ring at the rear side of the Shaft.
6. Slide the Pulley on to the Roller Shaft.
7. Place the Belt over the Pulley.
8. Install the retaining ring on the Drive Roller N5.
9. Move the Tensioner of the M2 motor belt into position and tighten the Screws (2).
10. Do ARP 3.1 to install the Punch Module.
11. Do ARP 1.6 to install the Rear Cover.
12. Close the Front Door.
13. Connect the Power Cord.

ARP 2.27 Stepper and Mount Assembly Replacement

PARTS LIST ON PL 2.6

Use this procedure to remove and install the Entrance Motor (M1), Accel Motor (M2), Exit Motor (M6), Decel Motor (M7), or Bypass Motor (M8).

WARNING

Do not perform Repair activities with the power on or electrical power supplied to the machine. Some machine components contain dangerous electrical voltages that can result in electrical shock and possible serious injury.

1. Disconnect the Power Cord.
2. Do ARP 1.6 to remove the Rear Cover.

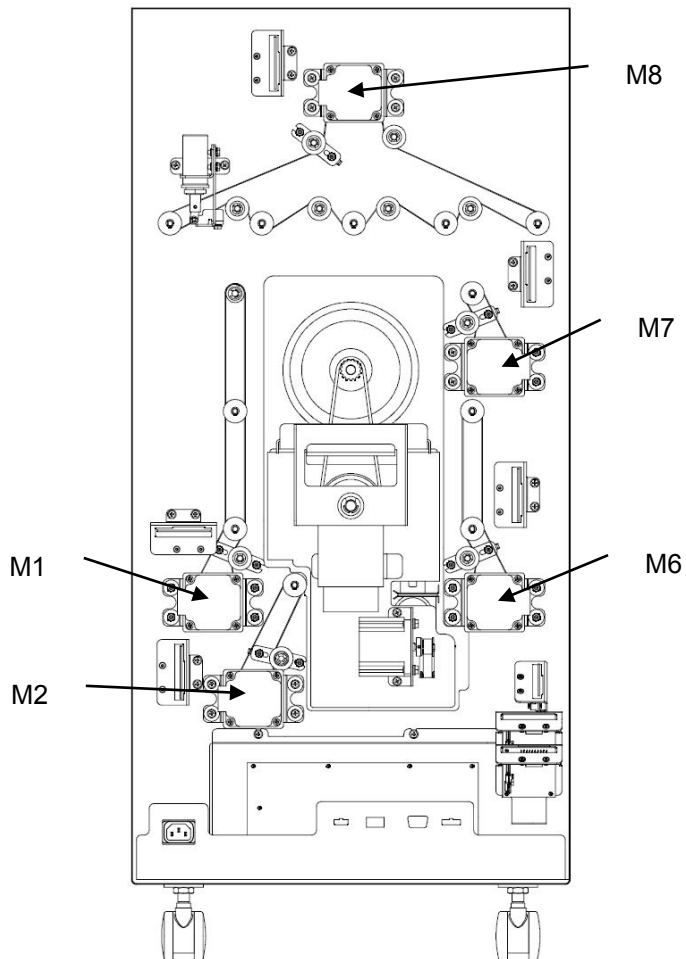

3. Locate the affected Motor (see PL 2.6).
4. Disconnect the Motor Connector from the corresponding Motor Driver (PL 2.6).
5. Loosen the corresponding Timing belt tensioner by loosening (2) M4 nuts.
6. Remove the M4 Screws or nuts and the flat washer (4) and the Stepper and Mount Assembly from the Rear Panel.

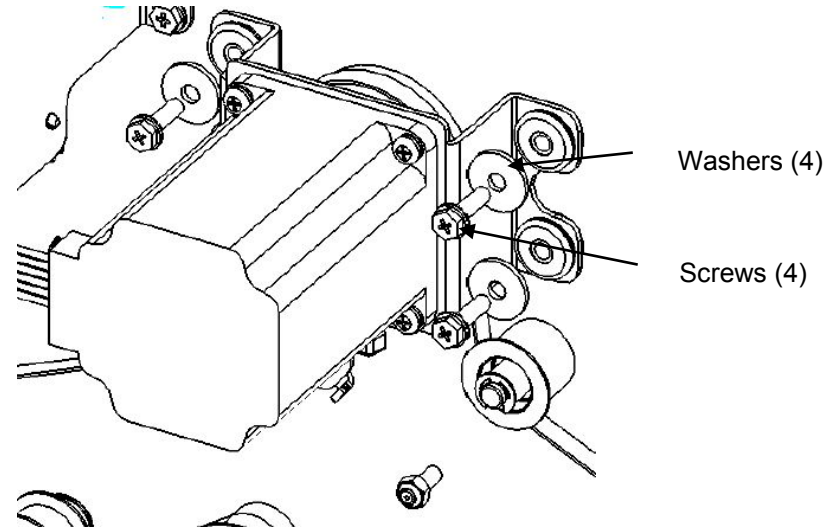

7. Place the Stepper and Mount Assembly in position and tighten the Screws (4).
8. Adjust the corresponding belt tension per ADJ 1.4 Timing belt adjustment procedure.
9. Connect the Motor Connector.
10. Do ARP 1.6 to install the Rear Cover.
11. Connect the Power Cord.

ARP 2.28 Paper Path Sensor Replacement

PARTS LIST ON PL PL 3.1, 3.2, PL 3.3, PL 3.4, PL 3.5, 4.2

Use the following procedures to remove and install the paper path sensors.

WARNING

Do not perform Repair activities with the power on or electrical power supplied to the machine. Some machine components contain dangerous electrical voltages that can result in electrical shock and possible serious injury.

Sensor #	ARP #	Sensor #	ARP #
S1	ARP 2.25.1	S15	ARP 2.25.7
S2	ARP 2.25.2	S16	ARP 2.25.8
S3	ARP 2.25.2	S17	ARP 2.25.8
S4	ARP 2.25.2	S18	ARP 2.25.5
S5	ARP 2.25.3	S19	ARP 2.25.5
S6	ARP 2.25.6	S20	ARP 2.25.5
S7	ARP 2.25.6	S21	ARP 2.25.5
S8	ARP 2.25.6	S22	ARP 2.25.2
S9	ARP 2.25.6	S23	ARP 2.25.2
S10	ARP 2.25.6	S24	ARP 2.25.2
S11	ARP 2.25.7	S25	ARP 2.25.1
S12	ARP 2.25.7	S26	ARP 2.25.1
S13	ARP 2.25.7	S28	ARP 2.25.4
S14	ARP 2.25.7		

ARP 2.28.1 Entrance Sensor (S1,) Exit Sensor (S25), and Bypass Middle Sensor (S26) Replacement

Use this procedure to remove and install the Sensor and Bracket Assembly for the Entrance Sensor, S1 and Exit Sensor, S25.

1. Disconnect the Power Cord.
2. Open the Front Door.

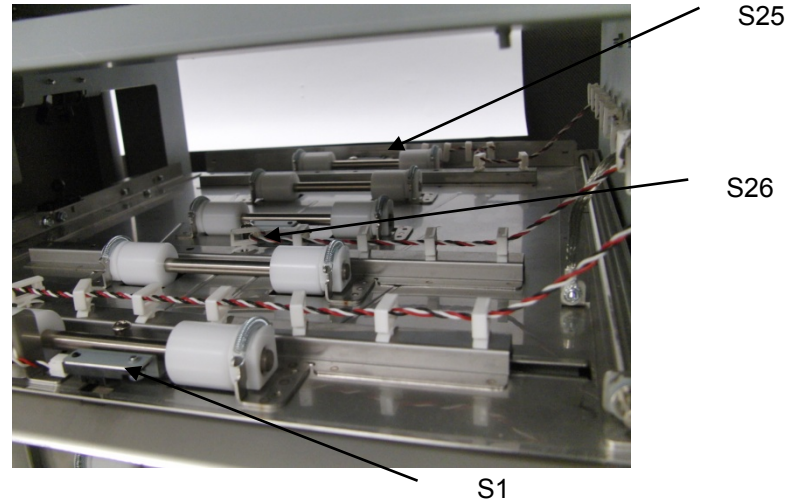

3. Disconnect the Sensor Connector at the Sensor.
4. Remove the Barrell screw that secures the Sensor to the sheet metal part.
5. Remove the old Sensor.
6. Place the new Sensor in position, then install the Barrell Screw.
7. Close the Front Door.
8. Connect the Power Cord.

ARP 2.28.2 Top, Middle, & Bottom Entrance Sensor (S2, S3, S4) and Top, Middle, & Bottom Exit Sensor (S22, S23, S24) Replacement

Use this procedure to remove and install the Sensor and Bracket Assembly for the Top, Middle, & Bottom Entrance Sensor (S2, S3, S4) and Exit Sensor (S22, S23, S24).

1. Disconnect the Power Cord.
2. Do GP 6.3 to undock the Punch from the upstream and downstream equipment.
3. Remove the docking bracket as needed to access the Sensor
4. Disconnect the sensor wire and the Sensor.
5. Remove the Barrel Screw that secures the Sensor to the sheet metal part.

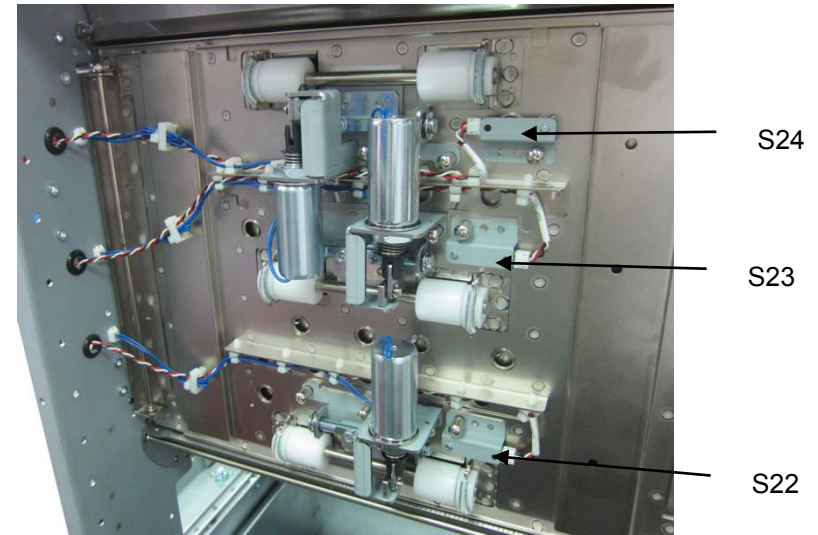
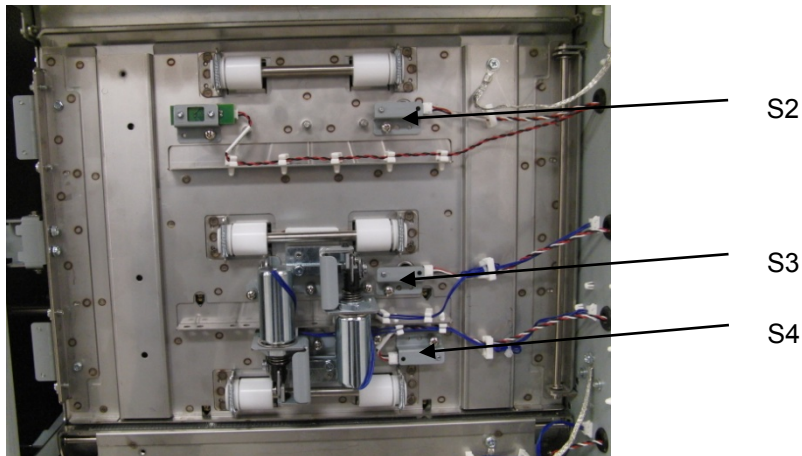

6. Remove the old Sensor.
7. Place the new Sensor in position, then install the Barrell Screw.
8. Do GP 6.4 to dock the Punch to the upstream and downstream equipment.
9. Connect the Power Cord.

ARP 2.28.3 **Accel Sensor (S5) Replacement**

Use this procedure to remove and install the Sensor and Bracket Assembly for the Accel Sensor (S5).

1. Disconnect the Power Cord.
2. Do GP 6.3 to undock the Punch from the upstream and downstream equipment.
3. Disconnect the sensor connector at the Sensor.
4. Remove the Barrel Screw that secures the Sensor to the sheet metal part.

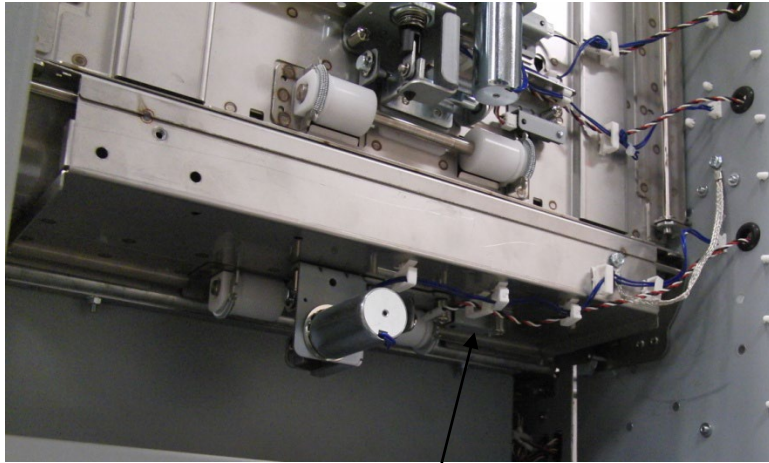

Accel Sensor (S5)

5. Remove the old Sensor.
6. Place the new Sensor in position, then install the Barrell Screw.
7. Do GP 6.4 to dock the Punch to the upstream and downstream equipment.
8. Connect the Power Cord.

ARP 2.28.4 **Align Home Sensor (S28) Replacement**

Use this procedure to remove and install the Sensor and Bracket Assembly for the Align Home Sensor (S28).

1. Disconnect the Power Cord.
2. Do GP 6.3 to undock the Punch from the upstream and downstream equipment.
3. Disconnect the Sensor Wire Connector from the Sensor.

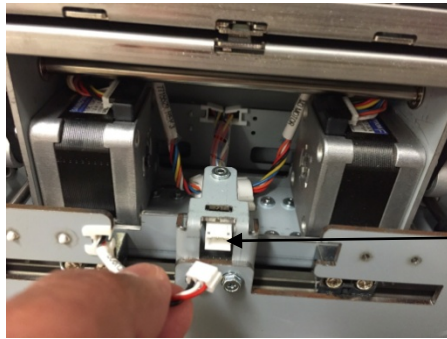

Sensor Wire Connector

4. Remove the M3 Screws (2) that secure the Sensor to the Bracket.

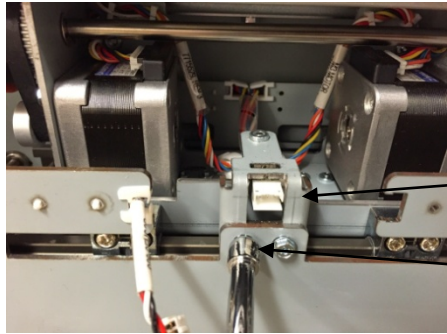

Sensor Bracket
Screws (2)

5. Remove the Sensor Sub-assembly.

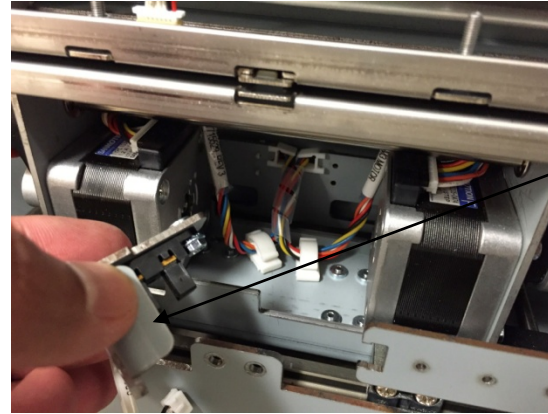

Sensor Sub-assembly

6. Place the new Sensor in position.
7. Tighten the M3 Screws (2) that secure the Sensor to the Bracket.
8. Connect the Sensor Connector to the Sensor.
9. Do GP 6.4 to dock the Punch to the upstream and downstream equipment.
10. Connect the AC power cord

ARP 2.28.5 **Backage Sensor Board Assembly (S18, S19) and Backage Sensor Board Assembly (S20, S21) Replacement**

Use this procedure to remove and install the Backage Sensor Board (S18, S19) or the Backage Sensor Board (S20, S21).

WARNING

Do not perform Repair activities with the power on or electrical power supplied to the machine. Some machine components contain dangerous electrical voltages that can result in electrical shock and possible serious injury.

1. Disconnect the Power Cord.
2. Do ARP 1.6 to remove the Rear Cover.
3. Do ARP 3.1 to remove the Punch Module.
4. Locate the Drive Entrance Panel
 - The upper board is the Backage Sensor Board (S20, S21).

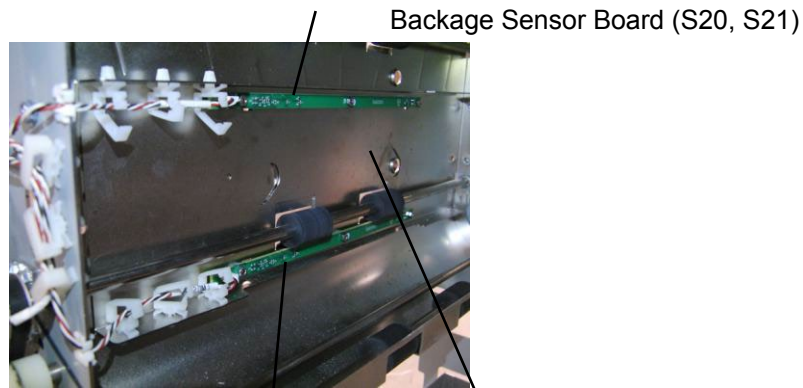

Backage Sensor Board (S18, S19)

Drive Entrance Panel

- The lower board is the Backage Sensor Board (S18, S19).

5. Disconnect the Sensor Board Connectors (2).

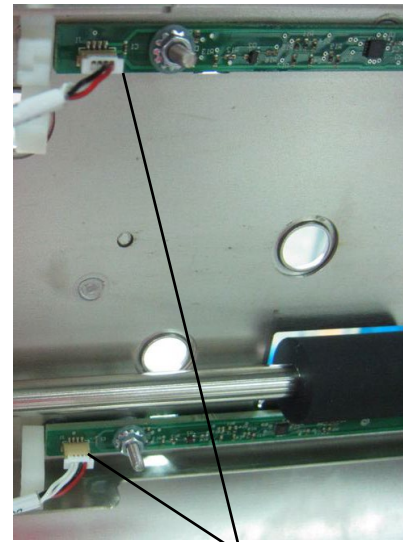

Sensor Board Connector (2)

6. Remove the Nuts (3) and Washers (3).
7. Remove the old Backage Sensor Board.
8. Place the new Punch Sensor Board in position.
9. Place the Washers (3) in position and tighten the Nuts (3).
10. Connect the Sensor Board Connector.
11. Do ARP 3.1 to install the Punch Module.
12. Do ARP 1.6 to install the Rear Cover.
13. Connect the Power Cord.

ARP 2.28.6 **Skew Sensor Board (S6 – S10) Replacement**

Use this procedure to remove and install the Skew Sensor Board (S6, S7, S8, S9, S10).

1. Disconnect the Power Cord.
2. Do ARP 1.6 to remove the Rear Cover.
3. Do ARP 3.1 to remove the Punch Module.

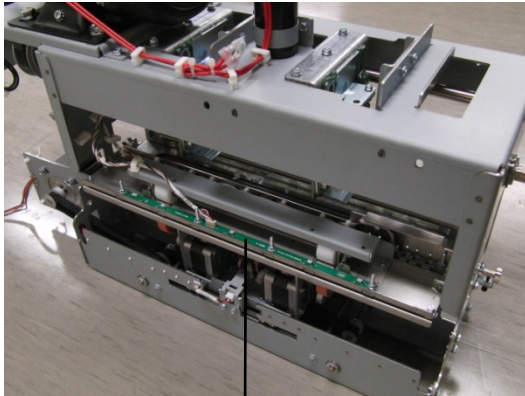

Skew Sensor Board

4. Disconnect the Skew Sensor Board Connector.

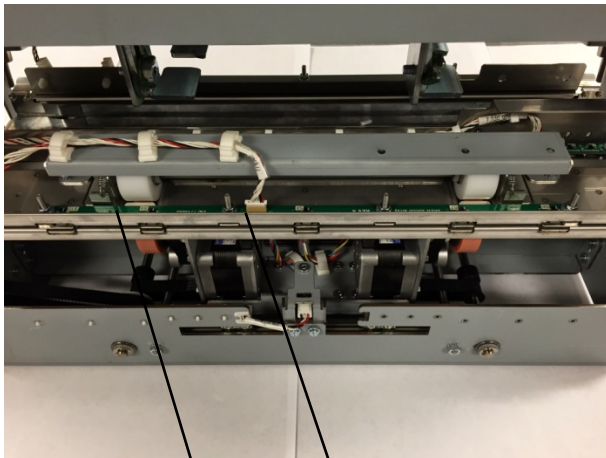

Skew Sensor Board Connector

Skew Sensor Board

5. Remove the Nuts (4), Washers (4), and the Skew Sensor Board. (do not remove the washers under the sensor board)

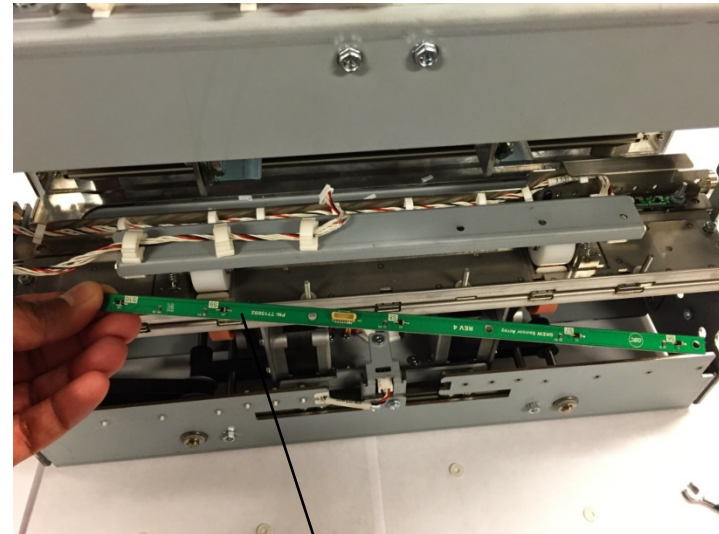

Skew Sensor Board

6. Place the new Skew Sensor Board in position.
7. Install the Washers (4) and tighten the Nuts (4). (Make sure there are (4) washers below the sensor board).
8. Connect the Sensor Board Connector.
9. Do ARP 3.1 to install the Punch Module.
10. Do ARP 1.6 to install the Rear Cover.
11. Connect the Power Cord.

ARP 2.28.7 Alignment Sensor Board (S11 – S15) Replacement

Use this procedure to remove and install the Alignment Sensor Board (S11, S12, S13, S4, S15).

1. Disconnect the Power Cord.
2. Do ARP 1.6 to remove the Rear Cover.
3. Do ARP 3.1 to remove the Punch Module.
4. Disconnect the Skew Sensor Board Connector.

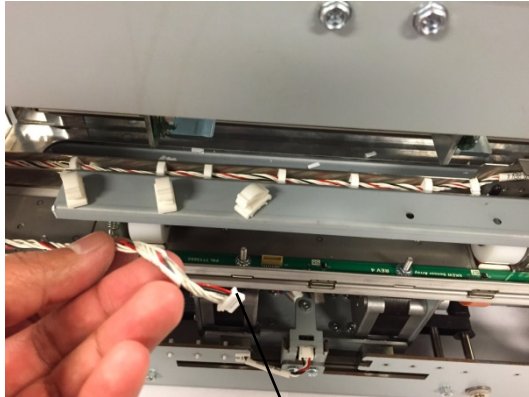

Skew Sensor Board Connector

5. Release the Cable Clamp and move the Cable out of the way.
6. Remove the M4 Nuts (2) and remove the steering idler roller cover.

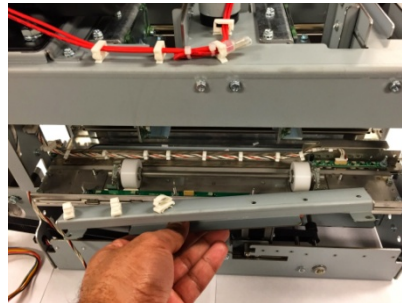
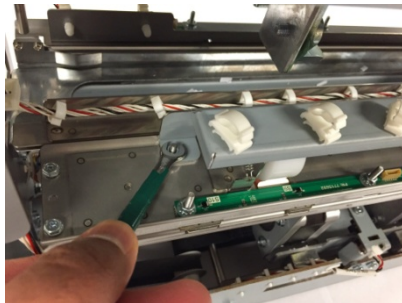

7. Remove the sleeve from the threaded stud.

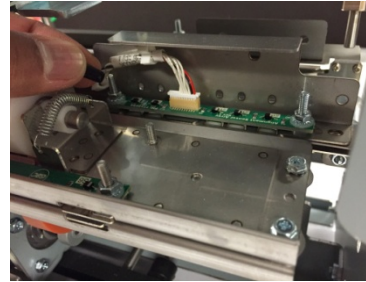

8. Disconnect the Alignment sensor board connector.

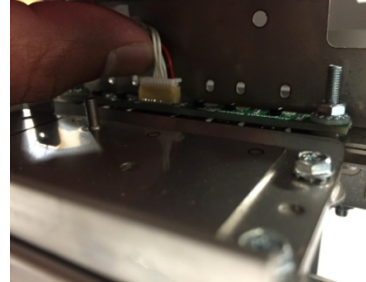

9. Release the Cable Clamp and move the Cable out of the way.

10. Remove the M4 Nuts (2) and Washers (2),

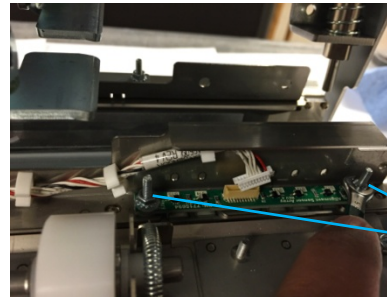

M4 nuts (2)
Washers (2)

11. Remove the Alignment Sensor Board.

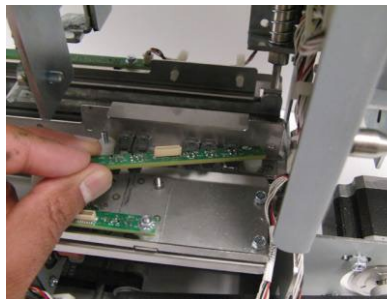

12. Place the new Alignment Sensor Board in position.
13. Install the Washers (2) and tighten the Nuts (2) (make sure there are washers below the board).
14. Install the sleeve removed at step 7.
15. Place the Alignment Sensor Board Cable into the Cable Clamps and close the Cable Clamps.
16. Connect the Alignment Sensor Board Connector.
17. Place the Roller Cover in position.
18. Place the Skew Sensor Board Cable into the Cable Clamps and close the Cable Clamps.
19. Connect the Skew Sensor Board Connector.
20. Do ARP 3.1 to install the Punch Module.
21. Do ARP 1.6 to install the Rear Cover.
22. Connect the Power Cord.

ARP 2.28.8 **Backage Sensor Board (S16, S17) Replacement**

Use this procedure to remove and install the Backage Sensor Board (S16, S17) or the Backage Sensor Bracket.

1. Disconnect the Power Cord.
2. Do ARP 1.6 to remove the Rear Cover.
3. Do ARP 3.1 to remove the Punch Module.

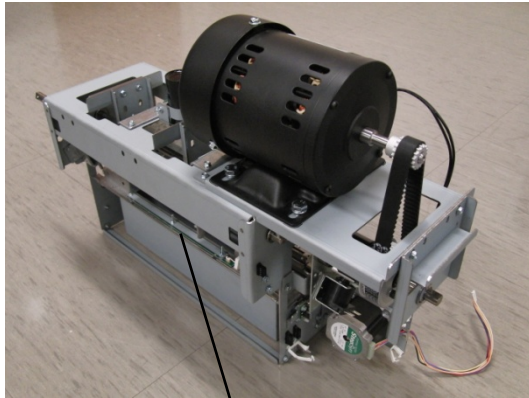

Backage Sensor Board

4. Disconnect the Sensor Board Connector at the Board.

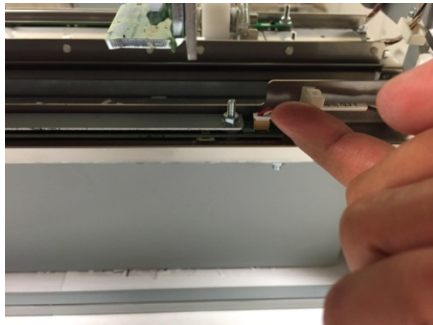

5. Remove the Nuts (3), Washers (3), and the Backage Sensor Board.

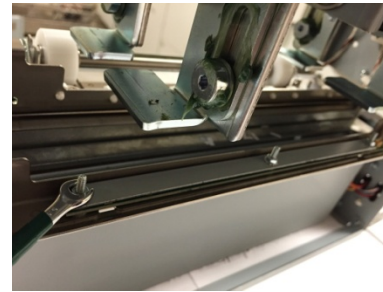

6. Place the new Backage Sensor Board in position.
7. Install the Washers (3) and tighten the Nuts (3)
8. Connect the Sensor Board Connector.
9. Do ARP 3.1 to install the Punch Module.
10. Do ARP 1.6 to install the Rear Cover.
11. Connect the Power Cord.

ARP 2.29 Motor Driver (Stepper Board) Replacement

PARTS LIST ON PL 2.6

Use this procedure to remove and install a Motor Driver (Stepper Board) - DRV M1, DRV M2, DRV M3, DRV M4, DRV M5, DRV M6, DRV M7, or DRV M8.

WARNING

Do not perform Repair activities with the power on or electrical power supplied to the machine. Some machine components contain dangerous electrical voltages that can result in electrical shock and possible serious injury.

1. Disconnect the Power Cord.
2. Do ARP 1.6 to remove the Rear Cover.
3. Locate the appropriate Motor Driver (see PL 2.6).
4. Disconnect the Connectors (3)

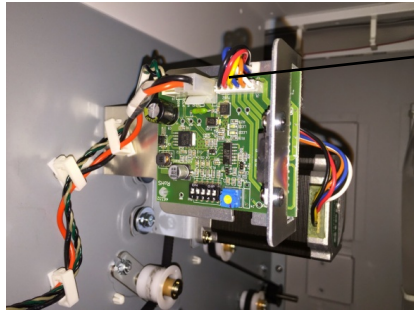

Connectors (3)

5. Remove the M4 Screws (2) and the Driver and Bracket Assembly.



Screws (2)

6. Disconnect the Cables from the Motor Driver Board.
7. Set the Dip switches (6) on the new Motor Driver in accordance with the table below.

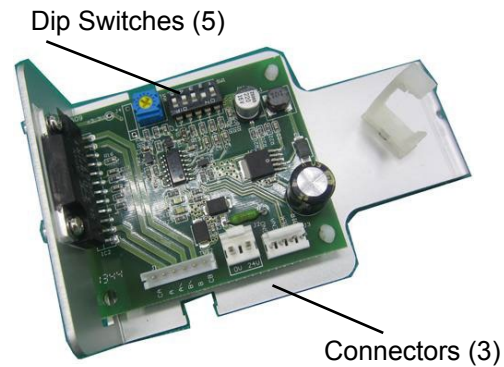

M1 Motor Driver		M2 Motor Driver		M3 Motor Drive	
1	Off	1	Off	1	Off
2	On	2	On	2	Off
3	Off	3	Off	3	On
4	On	4	On	4	Off
5	Off	5	Off	5	On
M4 Motor Driver				M5 Motor Drive	
1	Off			1	Off
2	Off			2	Off
3	On			3	On
4	Off			4	Off
5	On			5	Off
M6 Motor Driver		M7 Motor Driver		M8 Motor Driver	
1	Off	1	Off	1	Off
2	On	2	On	2	On
3	Off	3	Off	3	Off
4	On	4	On	4	Off
5	Off	5	Off	5	Off

8. Place the Driver and Bracket Assembly in position and tighten the M4 Screws (2).
9. Connect the Connectors (3).
10. Do ARP 1.6 to install the Rear Cover.
11. Connect the Power Cord.

ARP 2.30 Solenoid Replacement

PARTS LIST ON PL 2.8 PL 3.2, PL 3.3, PL 3.4

Use this procedure to remove and install the Solenoids in these assemblies:

Solenoid	Solenoid #	ARP #
Diverter Subassembly	SOL 1	ARP 2.30.1
Punch Clutch	SOL 2	ARP 3.7
Entrance Idler Solenoid, Middle	SOL 3	ARP 2.30.2
Entrance Idler Solenoid, Bottom	SOL 4	ARP 2.30.2
Acceleration Roller Idler Solenoid	SOL 5	ARP 2.30.3
Exit Idler Solenoid, Bottom	SOL 6	ARP 2.30.4
Exit Idler Solenoid, Middle	SOL 7	ARP 2.30.4
Exit Idler Solenoid, Top	SOL 8	ARP 2.30.4

WARNING

Do not perform Repair activities with the power on or electrical power supplied to the machine. Some machine components contain dangerous electrical voltages that can result in electrical shock and possible serious injury.

ARP 2.30.1 Diverter Solenoid Replacement

PARTS LIST ON PL 2.3

Use this procedure to remove and install the Diverter Solenoid Assembly (SOL 1).

WARNING

Do not perform Repair activities with the power on or electrical power supplied to the machine. Some machine components contain dangerous electrical voltages that can result in electrical shock and possible serious injury.

Removal Procedure

1. Disconnect the Power Cord.
2. Do ARP 1.6 to remove the Rear Cover.
3. Do ARP 1.16 to remove the Exhaust Fan Bracket.
4. Remove the M4 (2) screws from the Diverter Shaft.

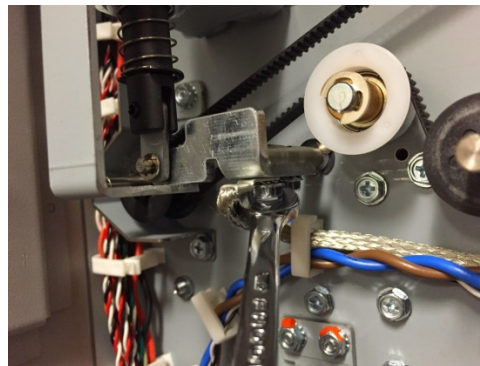

5. Disconnect the inline Connector for the Diverter Solenoid sub-assembly.

6. Remove Screws (2) from the diverter solenoid sub assembly.

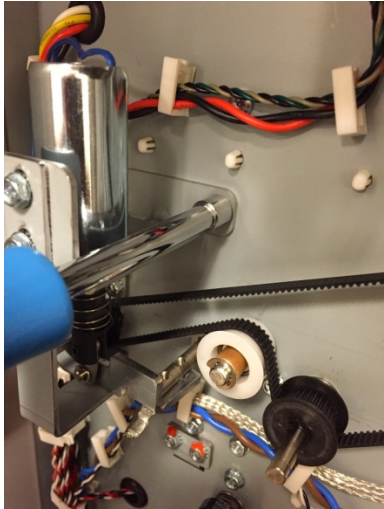

7. Remove the Diverter Solenoid Sub-assembly.

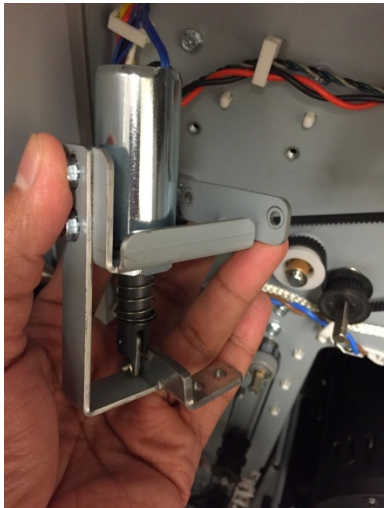

3. Place the the Cable into the Cable Clamps and close the Cable Clamps
4. Do ADJ 1.2 Diverter solenoid adjustment.
5. Do ARP 1.16 to install the Exhaust Fan Bracket
6. Do ARP 1.6 to install the Rear Cover.
7. Connect the Power Cord.

Installation Procedure

1. Place the new Solenoid in position and tighten the Screws (2) to the rear frame and two screws to the diverter shaft
2. Connect the inline Connector for the Diverter Solenoid.

ARP 2.30.2 **Entrance Idler Solenoid Replacement**

Use this procedure to remove and install the Entrance Idler Solenoids (SOL 3 & SOL 4).

1. Disconnect the Power Cord.
2. Do GP 6.3 Undock the Punch.
3. Open the Front Door.
4. Disconnect the Solenoid Connector for the Solenoid being replaced.

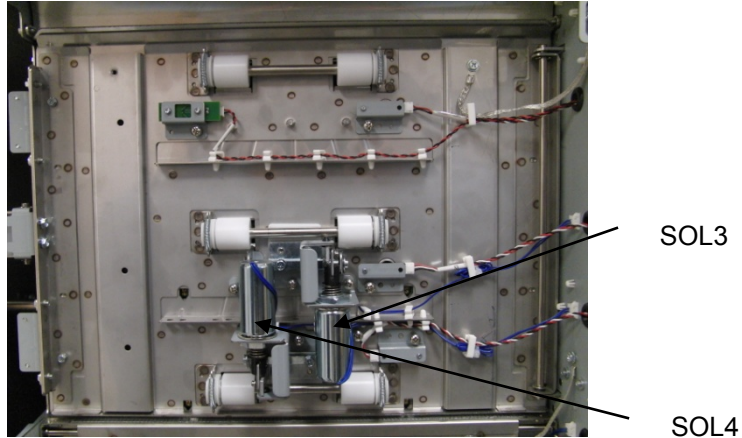

5. Open the Cable Clamps and remove the Cable.
6. Remove the M4 Barrel Screws (3) and the Solenoid assembly.
7. Place the new Solenoid assembly in position and tighten the barrel Screws (3).
8. Connect the Solenoid Connector.
9. Place the the Cable into the Cable Clamps and close the Cable Clamps
10. Close the Front Door.
11. Do GP 6.4 Dock the Punch.
12. Connect the Power Cord.

ARP 2.30.3 **Acceleration Roller Idler Solenoid Replacement**

Use this procedure to remove and install the Acceleration Roller Idler Solenoid (SOL 5).

1. Disconnect the Power Cord.
2. Do GP 6.3 Undock the Punch.
3. Open the Front Door.
4. Disconnect the Solenoid Connector.

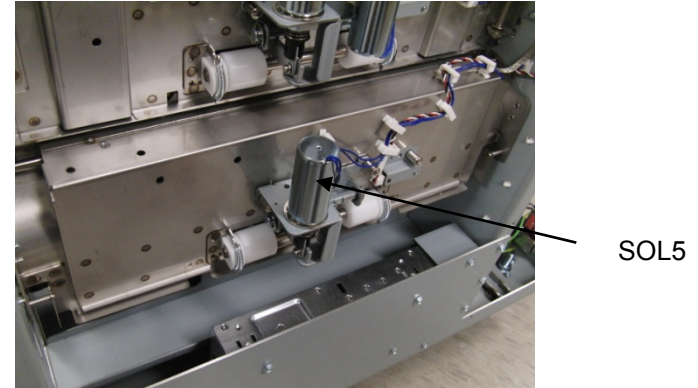

5. Open the Cable Clamps and remove the Cable.
6. Remove the M4 Barrel Screws (3) and the Solenoid.
7. Place the new Solenoid in position and tighten the barrel Screws (3).
8. Connect the Solenoid Connector.
9. Place the the Cable into the Cable Clamps and close the Cable Clamps
10. Close the Front Door.
11. Do GP 6.4 Dock the Punch.
12. Connect the Power Cord.

ARP 2.30.4 *Exit Idler Solenoid Replacement*

Use this procedure to remove and install the Exit Idler Solenoids (SOL 6, SOL 7, & SOL 8)

1. Disconnect the Power Cord.
2. Do GP 6.3 Undock the Punch.
3. Do ARP 1.18 to remove the Downstream side cover.
4. Open the Front Door.
5. Disconnect the Solenoid Connector.

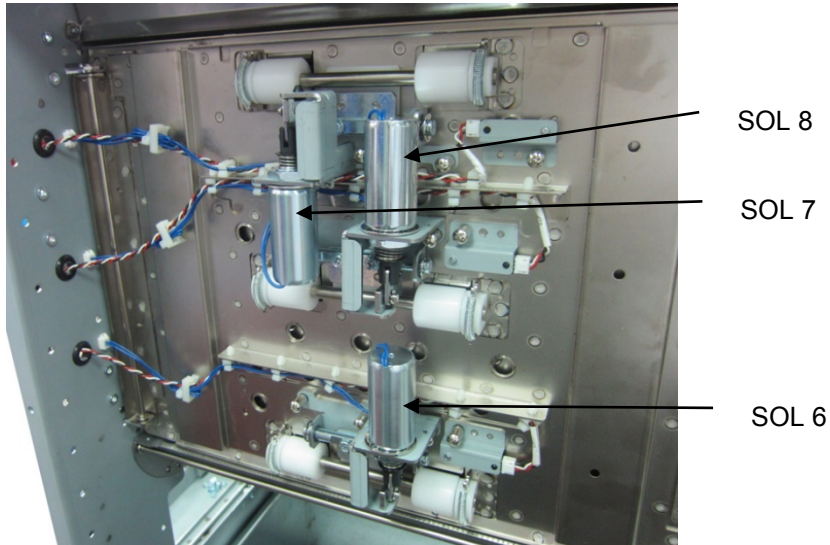

6. Open the Cable Clamps and remove the Cable.
7. Remove the M4 Barrel Screws (3) and the Solenoid.
8. Place the new Solenoid in position and tighten the Screws (3).
9. Connect the Solenoid Connector.
10. Place the the Cable into the Cable Clamps and close the Cable Clamps
11. Close the Front Door.
12. Do GP 6.4 Dock the Punch.
13. Connect the Power Cord.

ARP 2.31 Upper Bypass Panel Anti-Static Brush Replacement

PARTS LIST ON PL 3.5

Use this procedure to replace the Anti-Static Brush on the Upper Bypass Panel.

WARNING

Do not perform Repair activities with the power on or electrical power supplied to the machine. Some machine components contain dangerous electrical voltages that can result in electrical shock and possible serious injury.

1. Disconnect the Power Cord.
2. Do GP 6.3 to undock the Punch from the downstream equipment.

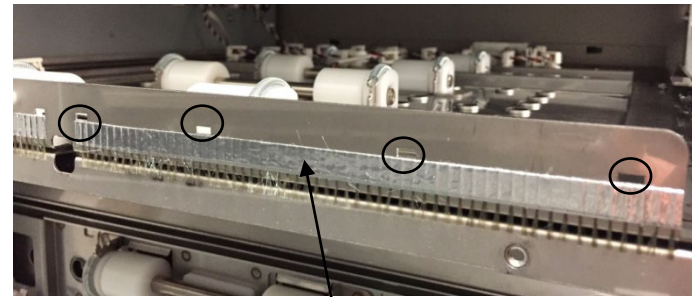

Anti-Static Brush

3. Peel off the old Anti-Static Brush.
4. Clean the surface with some rubbing alcohol
5. Affix the new brush inside referencing the cut-outs as shown above.
6. Do GP 6.4 to dock the Punch from the downstream equipment.
7. Connect the Power Cord.

3. Punch Module

ARP 3.1 Punch Module Replacement

PARTS LIST ON PL 4.1

Use this procedure to remove and install the Punch Module.

ARP 3.1.1 *Punch Module Removal*

WARNING

Do not perform Repair activities with the power on or electrical power supplied to the machine. Some machine components contain dangerous electrical voltages that can result in electrical shock and possible serious injury.

1. Disconnect the Power Cord.
2. Do ARP 1.6 to remove the Rear Cover.
3. Open the Front Door.
4. If a die set is installed, remove it and store it in the die storage rack.



5. Use the levers (blue) to open the Acceleration Roller Idler Panel and the Exit panel.

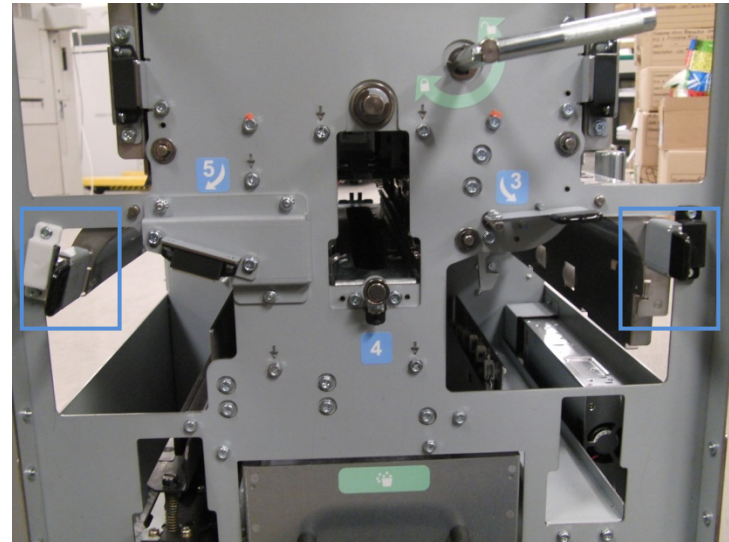

6. Remove the M4 X 10 Phillips Head Screw and the Die Lock Handle.

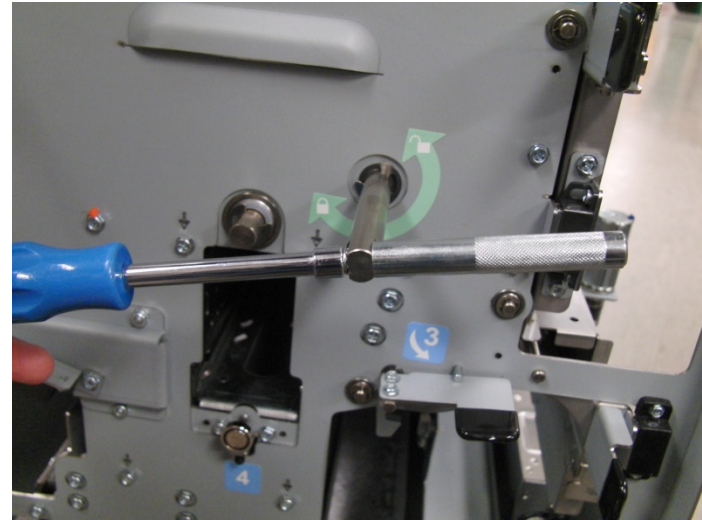

7. Remove the M4 Screws (5) from the Front Frame. The screws to be removed are marked with a downward arrow (↓).



8. Go to the rear of the Punch.
9. Disconnect the Connectors (2) for Sensors S6-S10 and S11-S15.

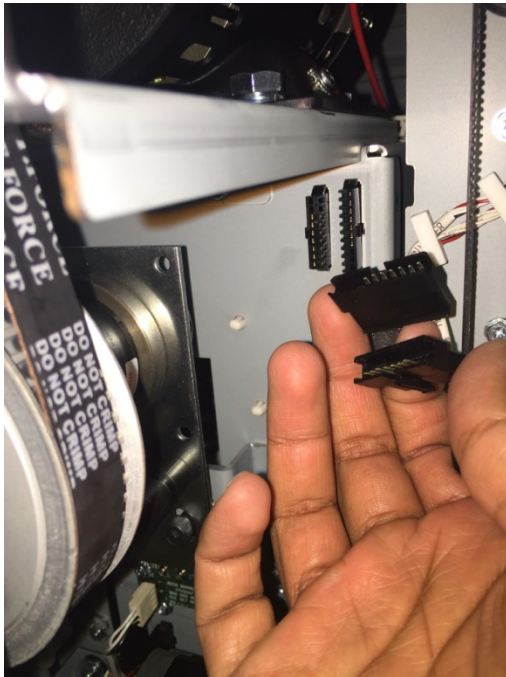

(Cont.)

10. Disconnect the Connector for Sensor S28.

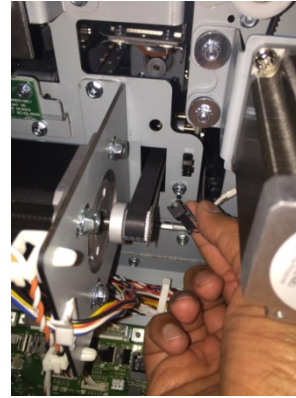

11. Disconnect the Connector for Solenoid SOL2.

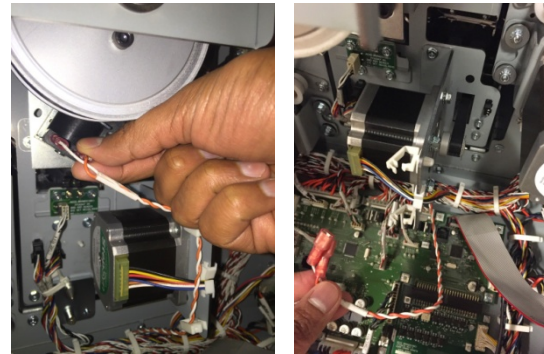

12. Disconnect the Connector for the M5 Motor Driver.

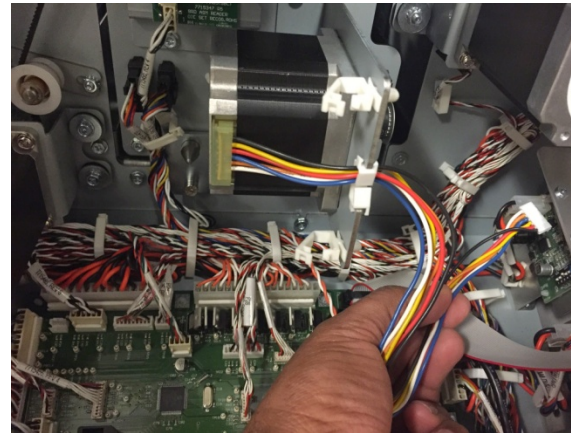

(Cont.)

13. Disconnect the Connectors (2) for the M3 Header and the M4 Header.

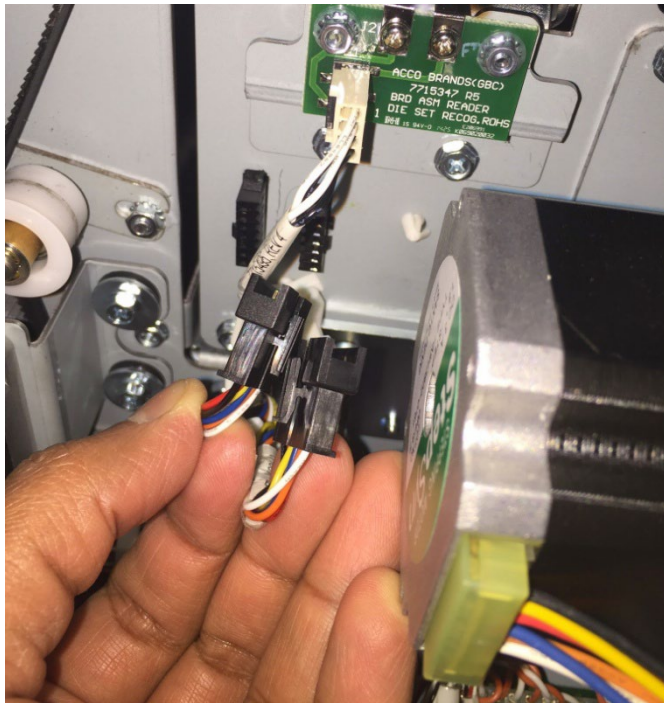

14. Disconnect the Die Set Recognition Connector.



15. Disconnect the Connector for Sensors S16 and S17.



16. Disconnect the Connector for Punch Motor M10.

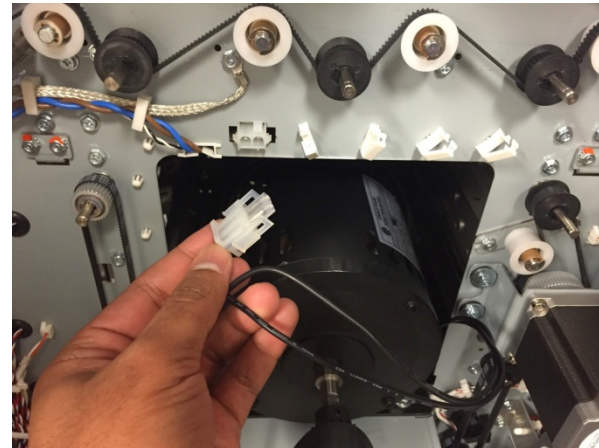

(Cont.)

17. Do the following to remove the Punch Module Mount Bracket (Lock Plates).

- Use a Phillips Head Screwdriver to remove the Screw from the right Punch Module Mount Bracket.
- Remove the right Punch Module Mount Bracket.

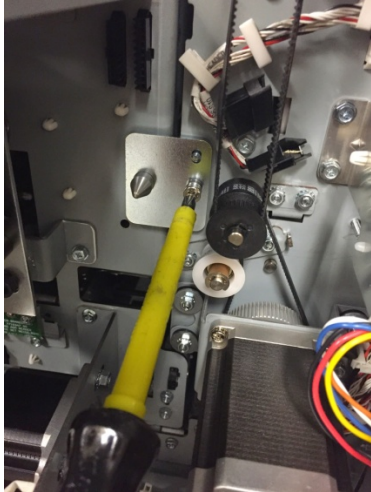

- Use a Phillips Head Screwdriver to remove the Screw from the right Punch Module Mount Bracket.
- Remove the right Punch Module Mount Bracket.



18. Do the following to remove the Punch Module

- Grasp the handle and slowly pull the punch module out for about 100mm.

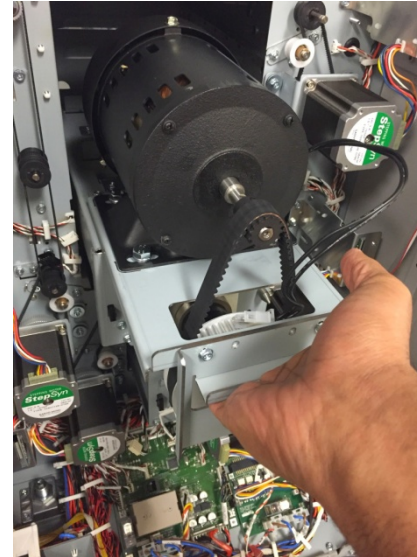

- Reach in and grasp the rear handle and continue to slide the punch. Lift the punch off the rail- DO NOT let it drop on the control board.

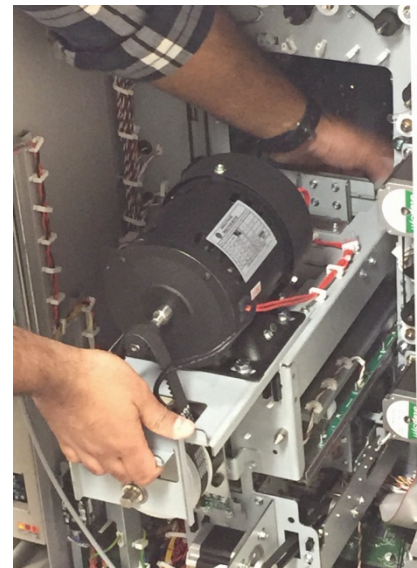

- Place the Punch Module on a flat surface.

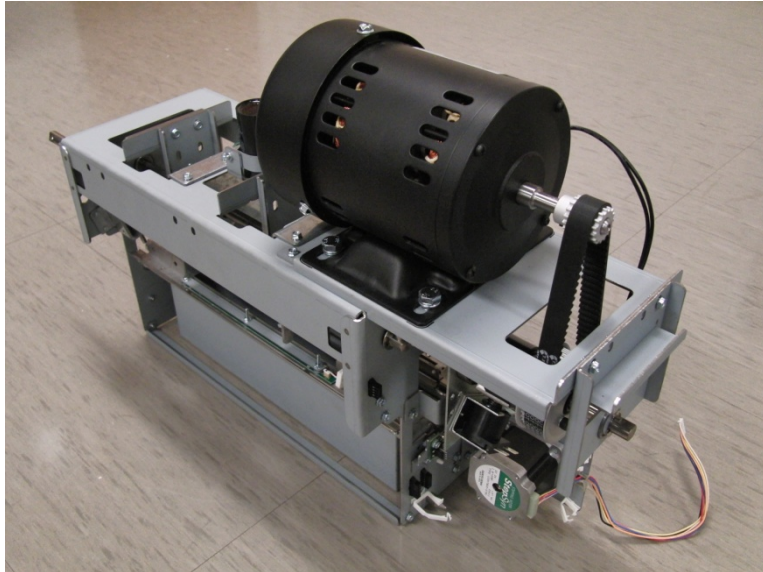

ARP 3.1.2 **Punch Module Installation**

Use this procedure to install the Punch Module.

1. Slide the Punch Module into the slot at the rear of the machine.
2. Install the punch module lock plates and tighten the captive screws.
3. Connect all electrical connectors for the below 10 components.
 - Connector for Punch Motor M10.
 - Connector for Sensors S16 and S17.
 - Die Set Recognition Connector (2 terminals)
 - Connectors (2) for the M3 Header and the M4 Header.
 - Connector for the M5 Motor Driver
 - Connector Solenoid SOL2.
 - Connector for Sensor S28.
 - Connectors (2) for Sensors S6-S10 and S11-S15.
4. Go to the front of the Punch
5. Tighten the M4 Screws (5) into the Front Frame.
6. Install the Die Lock Handle and tighten the M4 X 10 Phillips Head Screw.
7. Install the Die Set (see *Operation Instructions Manual*).
8. Close the Front Door.
9. Do ARP 1.6 to install the Rear Cover.
10. Connect the Power Cord.

ARP 3.2 Chip Tray Home Switch Replacement

PARTS LIST ON PL 2.5

Use this procedure to remove and install the Chip Tray Home Switch (SW2).

1. Open the Front Door.

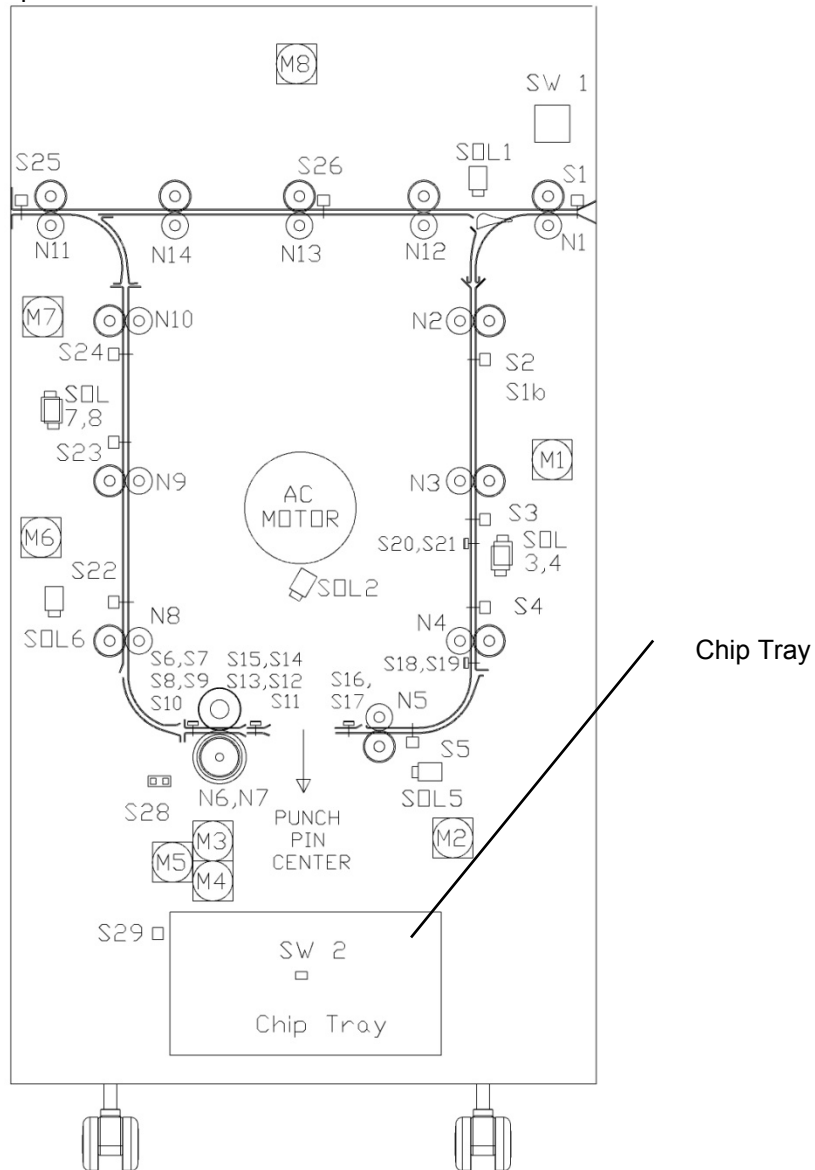

2. Remove the Chip Tray.
3. Disconnect Cable 7715485 at the Chip Tray Home Switch.

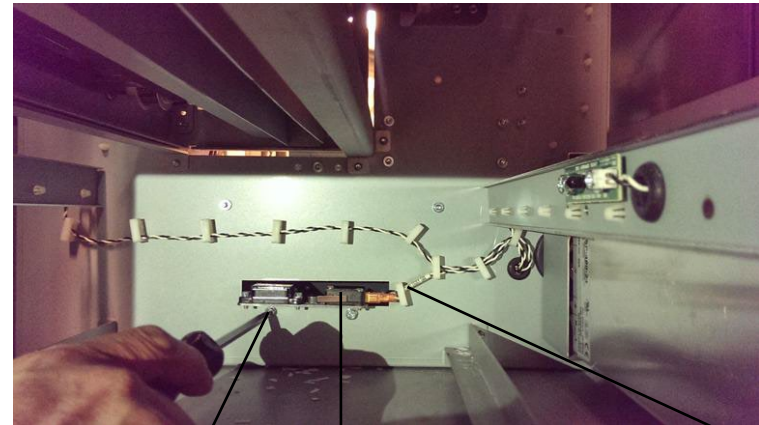

Screws (2) Chip Tray Home Switch Cable

4. Remove the Screws (2) and the old Chip Tray Home Switch Bracket.
5. Place the new Chip Tray Home Switch Bracket in position and tighten the Screws (2).
6. Connect Cable 7715485 at the Chip Tray Home Switch.
7. Put the Chip Tray in position and push the Chip Tray Assembly in firmly until it latches.
8. Close the Front Door.
9. Connect the Power Cord.

ARP 3.3 Chip Level Emitter Replacement

PARTS LIST ON PL 2.5

Use this procedure to remove and install the Chip Level Emitter Assembly.

WARNING

Do not perform Repair activities with the power on or electrical power supplied to the machine. Some machine components contain dangerous electrical voltages that can result in electrical shock and possible serious injury.

1. Disconnect the Power Cord.
2. Open the Front Door.
3. Remove the Chip Tray.
4. Locate the Chip Level Emitter on the Frame at the left (downstream) side of the Chip Tray compartment.
5. Disconnect Cable 7715485 at the Chip Level Emitter.

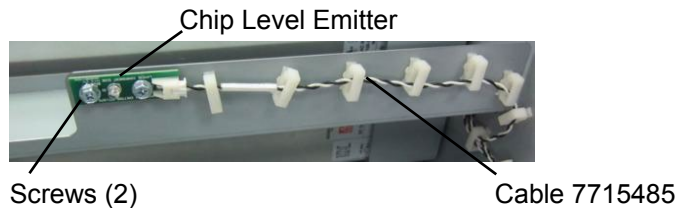

6. Remove the Screws (2) and the old Chip Level Emitter.
There will be Washers (4) between the Sensor and the sheet metal Bracket.
7. Place the new Chip Level Emitter, and the Washers (4), in position and tighten the Screws (2).
8. Connect Cable 7715485 at the Chip Level Emitter.
9. Put the Chip Tray in position and push the Chip Tray Assembly in firmly until it latches.
10. Close the Front Door.
11. Connect the Power Cord.

ARP 3.4 Chip Level Receiver Replacement

PARTS LIST ON PL 2.5

Use this procedure to remove and install the Chip Level Receiver Assembly.

WARNING

Do not perform Repair activities with the power on or electrical power supplied to the machine. Some machine components contain dangerous electrical voltages that can result in electrical shock and possible serious injury.

1. Disconnect the Power Cord.
2. Open the Front Door.
3. Remove the Chip Tray.
4. Locate the Chip Level Receiver on the Frame at the right (upstream) side of the Chip Tray compartment.
5. Disconnect Cable 7715485 at the Chip Level Receiver.

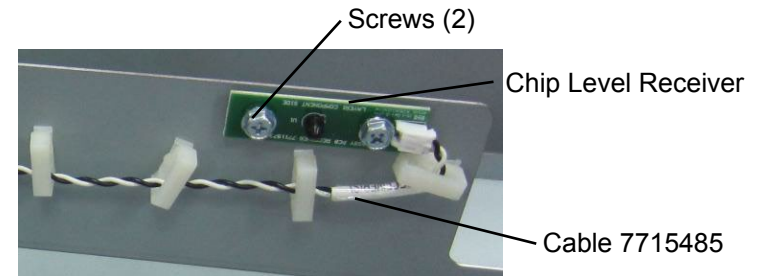

6. Remove the Screws (2) and the old Chip Level Receiver.
There will be Washers (4) between the Sensor and the sheet metal Bracket.
7. Place the new Chip Level Receiver, and the Washers (4), in position and tighten the Screws (2).
8. Connect Cable 7715485 at the Chip Level Receiver.
9. Put the Chip Tray in position and push the Chip Tray Assembly in firmly until it latches.
10. Close the Front Door.
11. Connect the Power Cord.

ARP 3.5 Punch Motor Replacement

PARTS LIST ON PL 4.11

Use this procedure to remove and install the Punch Motor (M10).

Removal Procedure

WARNING

Do not perform Repair activities with the power on or electrical power supplied to the machine. Some machine components contain dangerous electrical voltages that can result in electrical shock and possible serious injury.

1. Disconnect the Power Cord.
2. Do ARP 1.6 to remove the Rear Cover.
3. Do ARP 3.1 to remove the Punch Module.

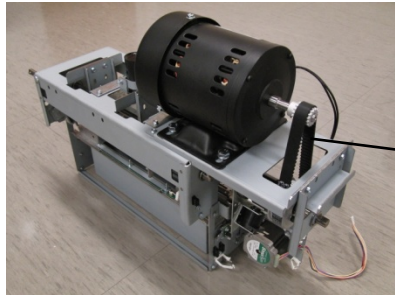

Punch Motor
Belt

4. Do ARP 3.6 Punch Motor Belt Replacement (Timing Belt) to remove the Punch Motor Belt.

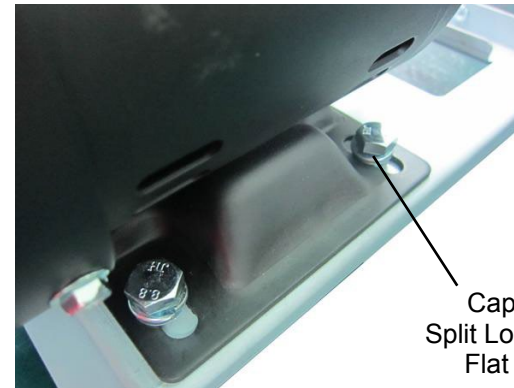
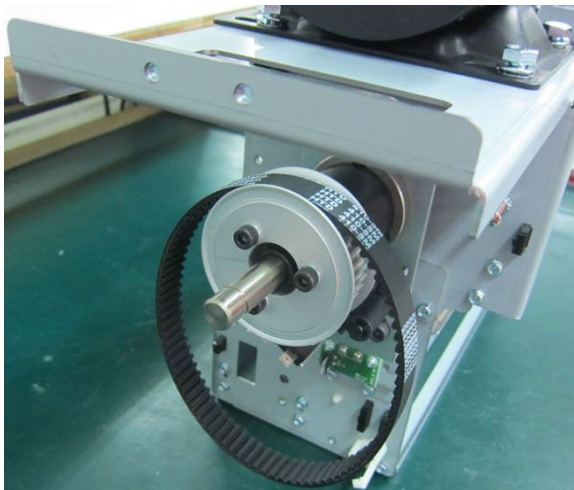

Cap Screws (4),
Split Lock Washers (4),
Flat Washers (4)

5. Remove the M8 Hex Cap Screws (4), the M8 Split Lock Washers (4), and the Flat Washers (4).
6. Remove the old Punch Motor.

Installation Procedure

1. Using the position marks on the Bracket, place the new Punch Motor in position.



Mark

2. Place the Flat Washers (4) and the M8 Split Lock Washers (4) in position.
3. Tighten the M8 Hex Cap Screws (4).
4. Do ARP 3.6 Punch Motor Belt Replacement (Timing Belt) to install the Punch Motor Belt.
5. Do ARP 3.1 to install the Punch Module.
6. Do ARP 1.6 to install the Rear Cover.
7. Connect the Power Cord.

ARP 3.6 Punch Motor Belt Replacement (Timing Belt)

PARTS LIST ON PL 4.1

Use this procedure to remove and install the Punch Motor Belt.

- (Belt, Timing, Punch Pulley, 115V)
- Belt, Timing, Punch Pulley, 230V

WARNING

Do not perform Repair activities with the power on or electrical power supplied to the machine. Some machine components contain dangerous electrical voltages that can result in electrical shock and possible serious injury.

1. Disconnect the Power Cord.
2. Do ARP 1.6 to remove the Rear Cover.
3. There is no need to uninstall the punch module, however for ease of operation it is a good idea to uninstall it using ARP 3.1
4. Remove the JE-10 E-Ring.



5. Remove the Nylon Washer.
6. Remove the Ball Bearing.
7. Remove the Screws (2) and the Bearing Bracket.

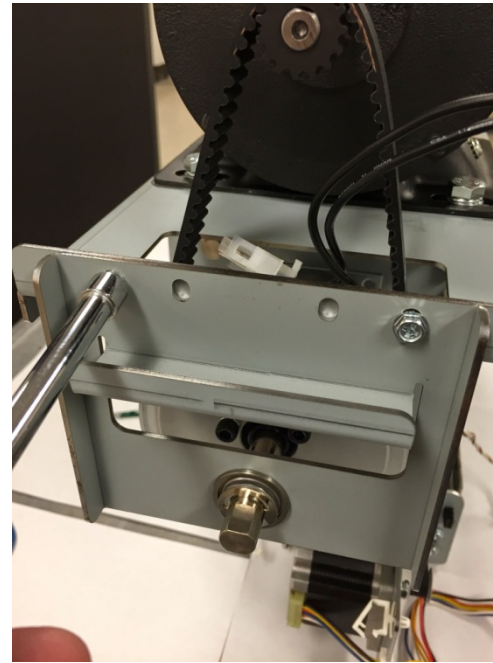

8. Remove the old Belt.

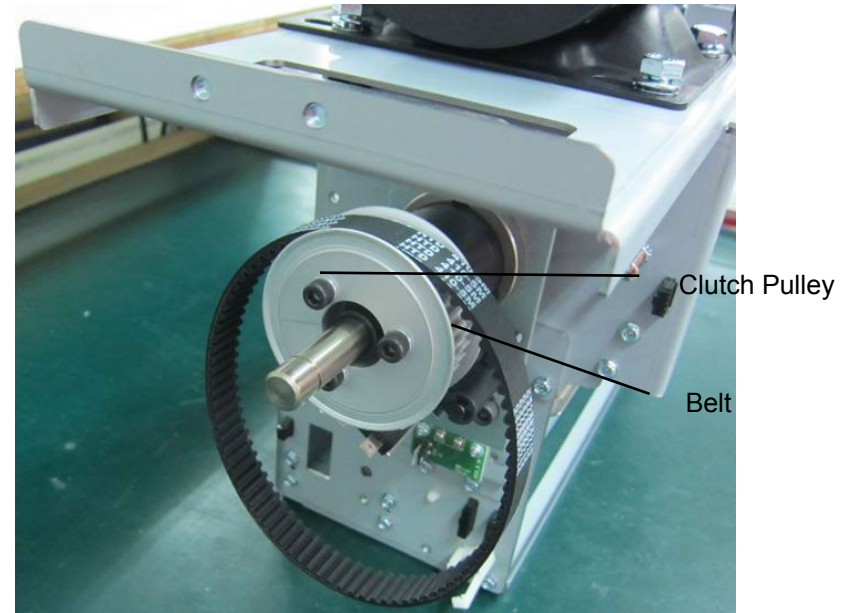

9. Place the new Belt around the Timing Pulley on the Punch Motor and the Clutch pulley.

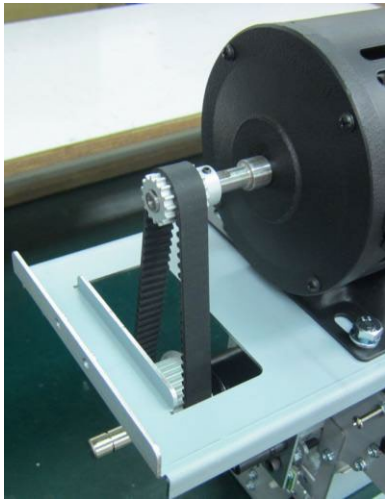

10. Place the Bearing Bracket in position and tighten the Screws (2).
 11. Place the Ball Bearing in position.
 12. Place the Nylon Washer in position.
 13. Place the E-Ring in position.
- NOTE: The tension on the Belt is set using the reference marks on the punch motor bracket (see ARP 3.5).



14. Do ARP 1.6 to install the Rear Cover.
15. Connect the Power Cord.

ARP 3.7 Clutch or Clutch Pulley Replacement

PARTS LIST ON PL 4.8

Use this procedure to remove and install the Clutch or the Clutch Pulley in the Punch Module.

Removal Procedure

WARNING

Do not perform Repair activities with the power on or electrical power supplied to the machine. Some machine components contain dangerous electrical voltages that can result in electrical shock and possible serious injury.

1. Disconnect the Power Cord.
2. Do ARP 1.6 to remove the Rear Cover.
3. Do ARP 3.1.1 Punch Module Removal.
4. Do ARP 3.6 to remove the Punch Motor Belt.
5. To remove the Clutch Pulley
 - Remove the M5X18 Screws (3) and Split Lock Washer (3)
 - Remove the Pulley and Flange.

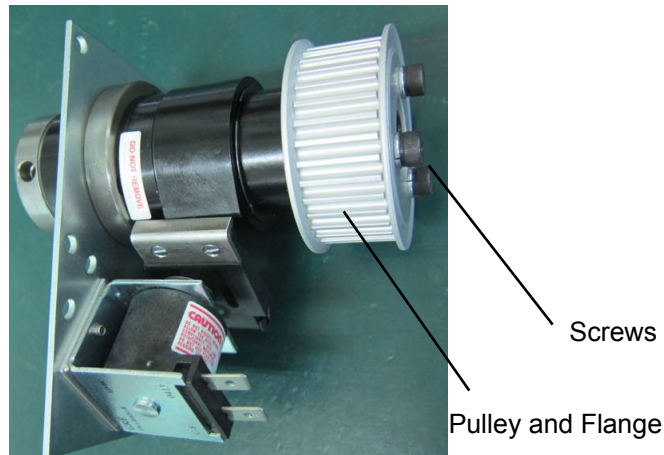

6. Remove the Lock Nut and the long M6 Screw.

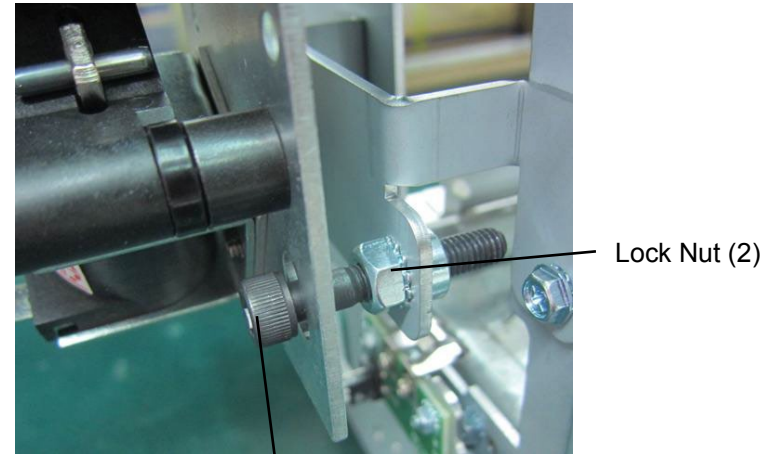

(Cont.)

7. Loosen the Set Screws (2) from the Clutch.

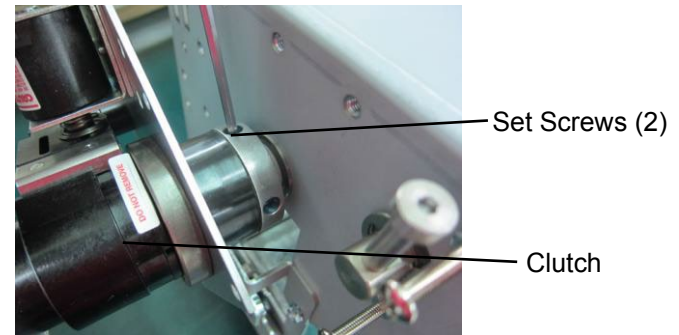

You can press down on the actuator and turn the punch shaft to orient the set screw in any direction for easy access.

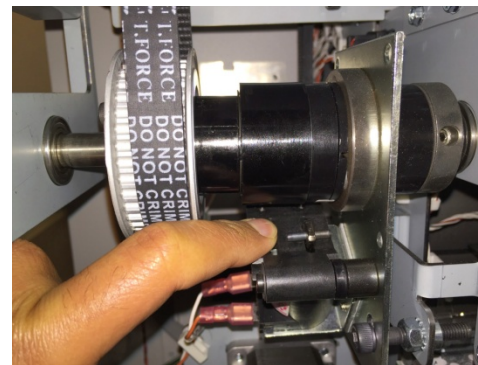

8. Remove the Clutch from the Shaft.

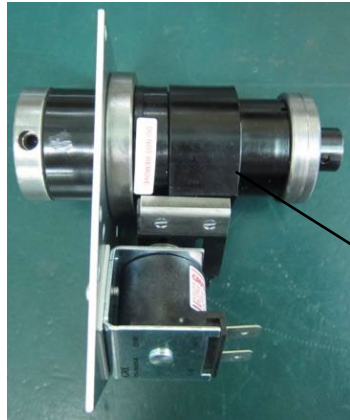

Clutch

Installation Procedure

1. Loosen the Set Screws (2) from the new Clutch.
2. Place the new Clutch in position on the Shaft.
3. Rotate the Clutch until the holes for the Set Screws line up with the notches on the Shaft.

The Cone point set screw should be properly seated in the notch of the Punch shaft.

4. Put a drop of Loctite on each Set Screw.
5. Tighten the Set Screws (2).
6. Place the long M6 Screw and the Lock Nuts (2) in position.

7. Use a shim of thickness between 3 and 5mm to set the gap between the head of the Screw and the Clutch Bracket.

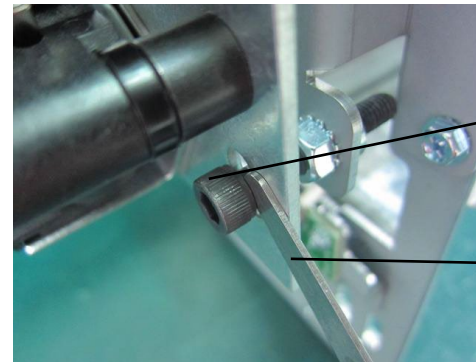

Long Screw

Shim

8. Use a 10 mm wrench and a 6mm Allen Wrench to tighten the Lock Nuts (2).

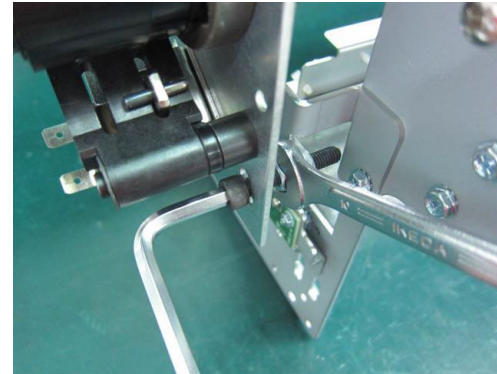

9. Recheck the gap.
(Cont.)

10. To replace the Clutch Pulley

- Place the Pulley and Flange in position.
- Tighten the M5X18 Screws (3) with the Split Lock Washers (3).

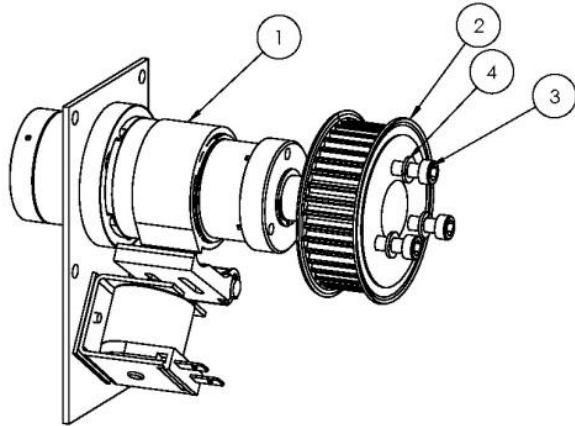

11. Place the Punch Shaft Bearing Bracket in position and tighten the Screws (2).
12. Do ARP 3.6 to install the Punch Motor Belt.
13. Do ARP 3.19 Ball Bearing Replacement to install the Ball Bearing.
14. Do ADJ 1.5 Punch Cam Indexing.
15. Do ARP 3.1.2 Punch Module Installation.
16. Do ARP 1.6 to install the Rear Cover.
17. Connect the Power Cord.

ARP 3.8 Punch Alignment Stepper Motor and Pulley Replacement, and Alignment Stepper Bracket Replacement

PARTS LIST ON PL 4.7

Use this procedure to remove and install the Punch Alignment Stepper Motor (M5) and Pulley, or the Alignment Stepper Mount Bracket.

Removal Procedure

WARNING

Do not perform Repair activities with the power on or electrical power supplied to the machine. Some machine components contain dangerous electrical voltages that can result in electrical shock and possible serious injury.

1. Disconnect the Power Cord.
2. Do ARP 1.6 to remove the Rear Cover.
3. Do ARP 3.1 to remove the Punch Module. (This step is optional; it is possible to replace the Alignment stepper bracket without removing the punch module.

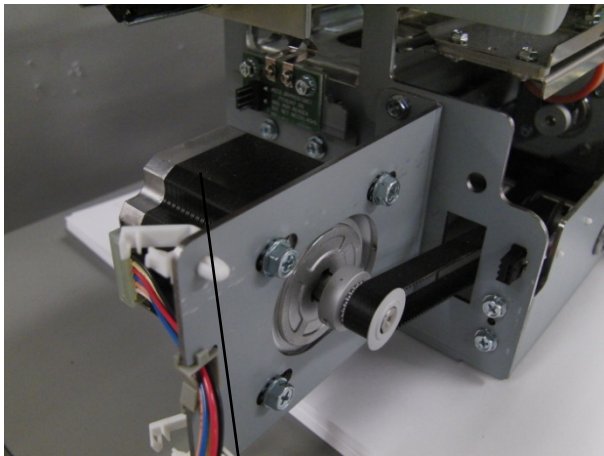

Punch Alignment Stepper Motor (M5)

4. Remove the Phillips Screws (4) and remove the timing belt.

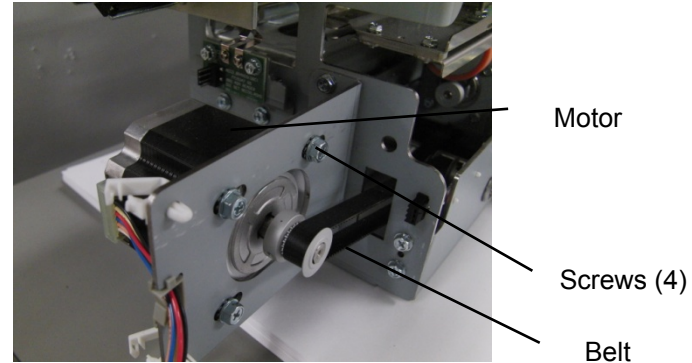

5. To replace the Alignment Stepper Mount Bracket
 - Remove the Screws (2) and the old Bracket.
 - Place the new Bracket in position and tighten the Screws (2).
6. Remove the Punch Alignment Stepper Motor and Pulley.
7. Place the timing Belt around the Pulley.
8. Do ADJ 1.4 to adjust the tension on the Belt.
9. Tighten the Phillips Screws (4).
10. Do ARP 3.1 to install the Punch Module if necessary
11. Close the Front Door.
12. Do ARP 1.6 to install the Rear Cover.
13. Connect the Power Cord.

ARP 3.9 Steering Module Replacement

PARTS LIST ON PL 4.1

Use this procedure to remove and install the Steering Module Sub Assembly.

Removal Procedure

WARNING

Do not perform Repair activities with the power on or electrical power supplied to the machine. Some machine components contain dangerous electrical voltages that can result in electrical shock and possible serious injury.

1. Disconnect the Power Cord.
2. Do ARP 1.6 to remove the Rear Cover.
3. Do ARP 3.1 to remove the Punch Module.

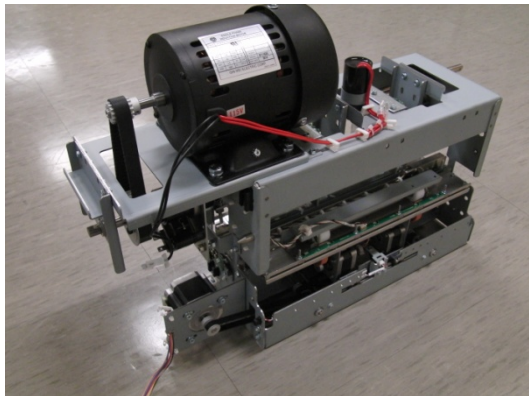

4. Disconnect the Skew Sensor Board Connector.

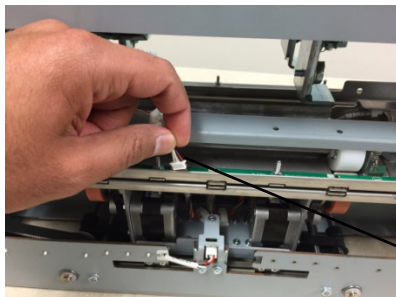

Skew Sensor Board Connector

5. Do the following to take the Alignment stepper belt off the pulley.

- Loosen the Phillips Screws (2).

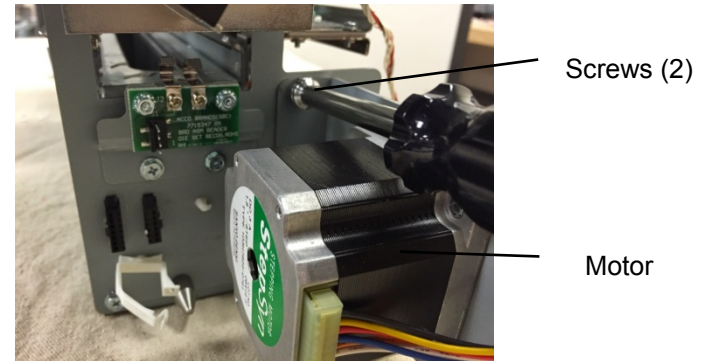

- Remove the Alignment stepper Belt from the Pulley.

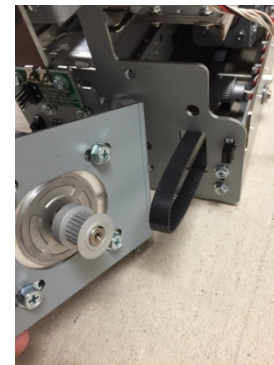

6. Pull the Alignment stepper belt in through the hole in the Frame.

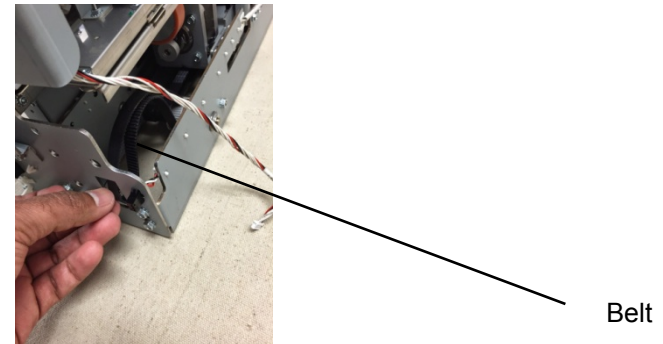

7. Disconnect the Left/Right Steering Stepper Connectors at the Punch Frame. One of the Connectors has 6 pins the other has 7 pins.

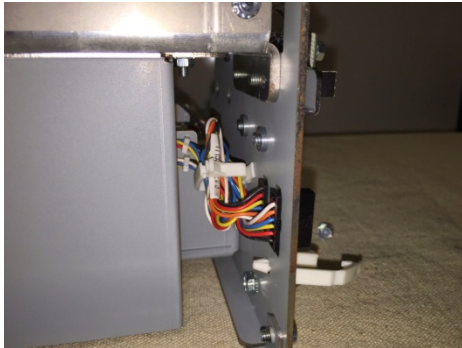

- Push the connector towards the outside of the frame.

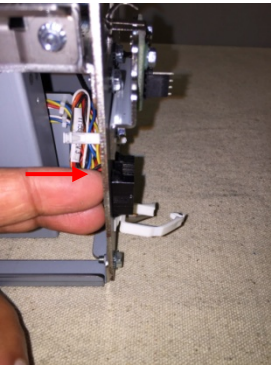

- Press down on the top tab to remove it from the top side. Then press the bottom tab to release the connector fully.

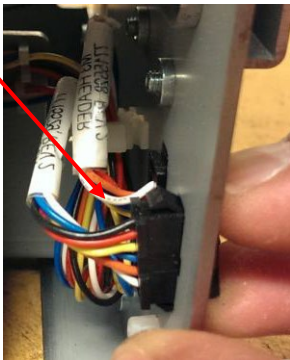

8. Release the Cable Clamp

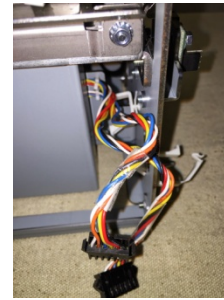

9. Similarly remove the Alignment home sensor connector.



10. Remove the Phillips Screws (8)- (4) from front side and (4) from rear side

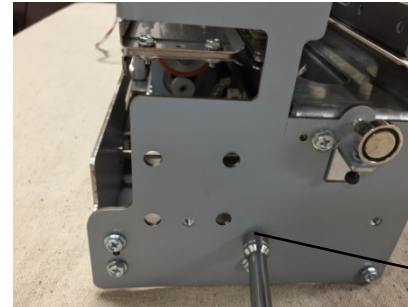

Screws (8)

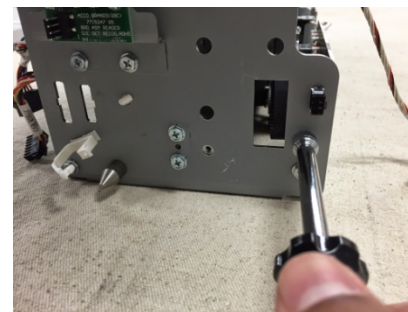

11. Remove the Steering Module from the Punch Module, by tilting the Steering Module as shown. This is to ensure the back side clears the self-clinching nut.

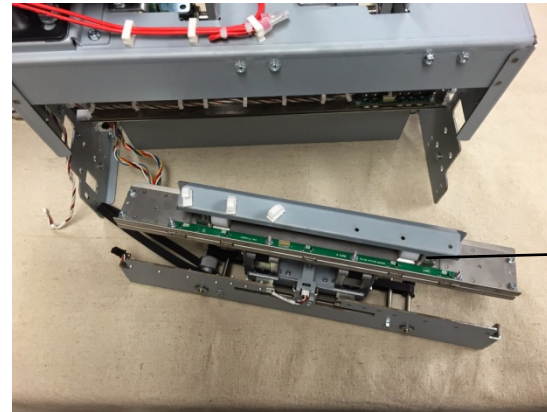
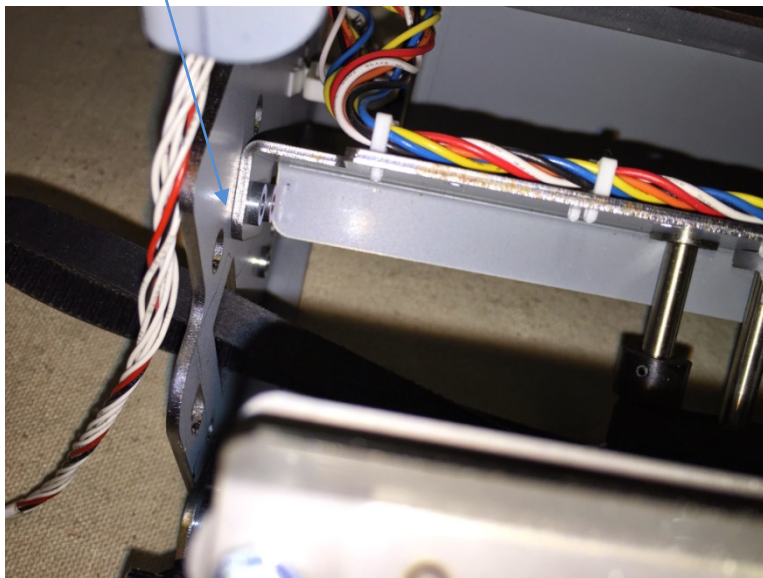

Steering Module

Installation Procedure

1. Place the Steering Module into the Punch Module.
2. Push the Steering Belt out through the hole in the Frame.
3. Install the Phillips Screws (8).
4. Connect the Align Home Sensor and the Left/Right Steering Motor Connectors.
5. Place the Alignment Stepper motor Belt around the Pulley.
6. Tighten the Phillips Screws (2).
7. Do ARP 3.1 to install the Punch Module.
8. Close the Front Door.
9. Do ARP 1.6 to install the Rear Cover.
10. Connect the Power Cord.

ARP 3.10 Ground Strap Replacement

PARTS LIST ON PL 4.3

Removal Procedure

Use this procedure to remove and install the Steering Carriage Ground Strap.

WARNING

Do not perform Repair activities with the power on or electrical power supplied to the machine. Some machine components contain dangerous electrical voltages that can result in electrical shock and possible serious injury.

1. Disconnect the Power Cord.
2. Do ARP 1.6 to remove the Rear Cover.
3. Do ARP 3.1 to remove the Punch Module.
4. Do ARP 3.9 to remove the Steering Module.

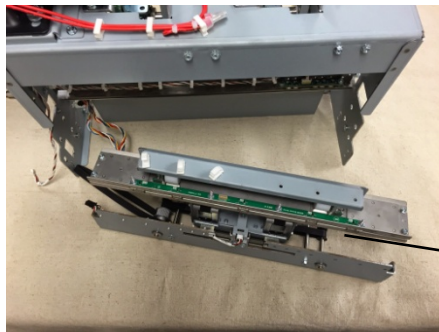

Steering Module

5. Remove the Phillips Screw from the Motor Bracket on the Drive Panel Steering Sub Assembly.

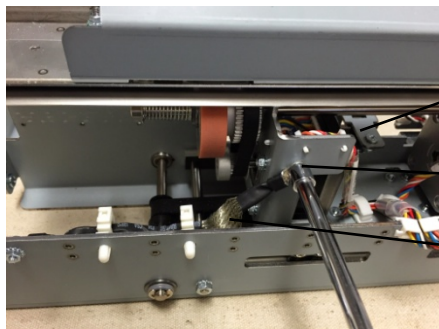

Motor Bracket

Screw

Ground Strap

6. Remove the Phillips Screw and Nut from the Ground Strap at the Alignment Carriage Sub Assembly.

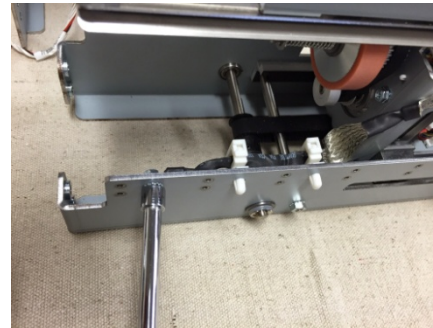

7. Remove the Ground Strap from the Wire Saddles.

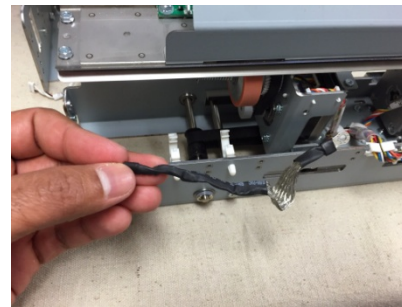

8. Remove the Steering Carriage Ground Strap.

Installation Procedure

1. Place the Steering Carriage Ground Strap in position.
2. Insert the Phillips Screw through the Ground Strap loop at the Alignment Carriage Sub Assembly; then tighten the Screw.
3. Insert the Phillips Screw through the Ground Strap loop and the Nut at the Motor Bracket; then tighten the Screw.
4. Place the Ground Strap into the Wire Saddles.
5. Do ARP 3.9 to install the Steering Module.
6. Do ARP 3.1 to install the Punch Module.
7. Do ARP 1.6 to install the Rear Cover.
8. Connect the Power Cord.

ARP 3.11 Alignment Carriage Sub Assembly Replacement

PARTS LIST ON PL 4.3

Use this procedure to remove and install the Alignment Carriage Sub Assembly.

Removal Procedure

WARNING

Do not perform Repair activities with the power on or electrical power supplied to the machine. Some machine components contain dangerous electrical voltages that can result in electrical shock and possible serious injury.

1. Disconnect the Power Cord.
2. Do ARP 1.6 to remove the Rear Cover.
3. Do ARP 3.1.1 to remove the Punch Module.
4. Do ARP 3.9 to remove the Steering module.

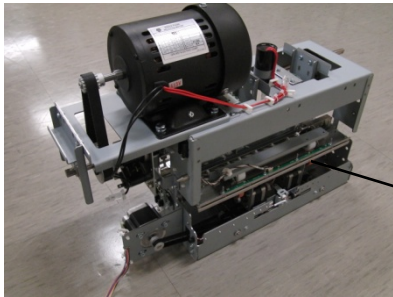

Steering Module

5. Remove the Steering Idler and Drive Panel assemblies by removing the M3 Nuts (4)

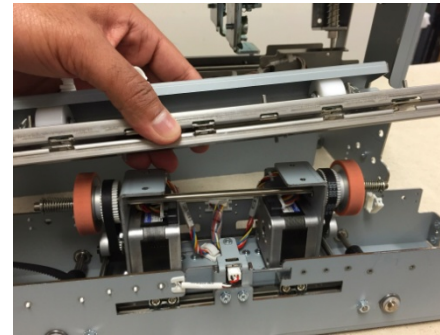
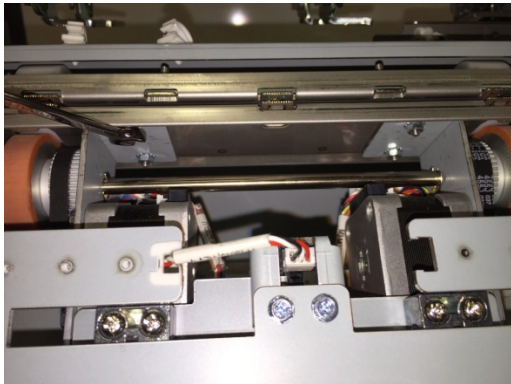

6. Remove (4) E-clips from steering drive roller shaft.

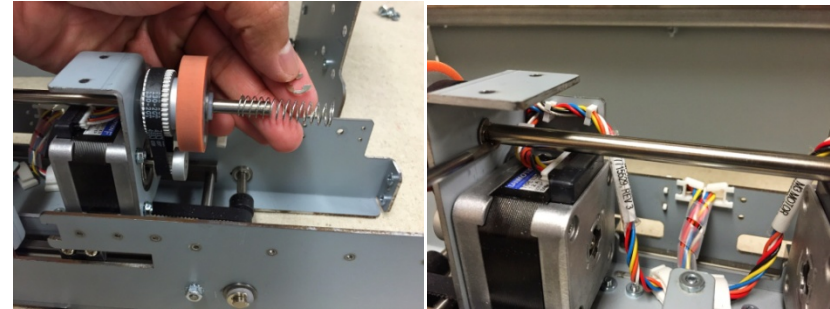

7. Remove the drive roller shaft and all the components on the drive shaft. (4 plastic washers; 2 springs; 2 drive rollers; 2 belts; 4 e-clips)

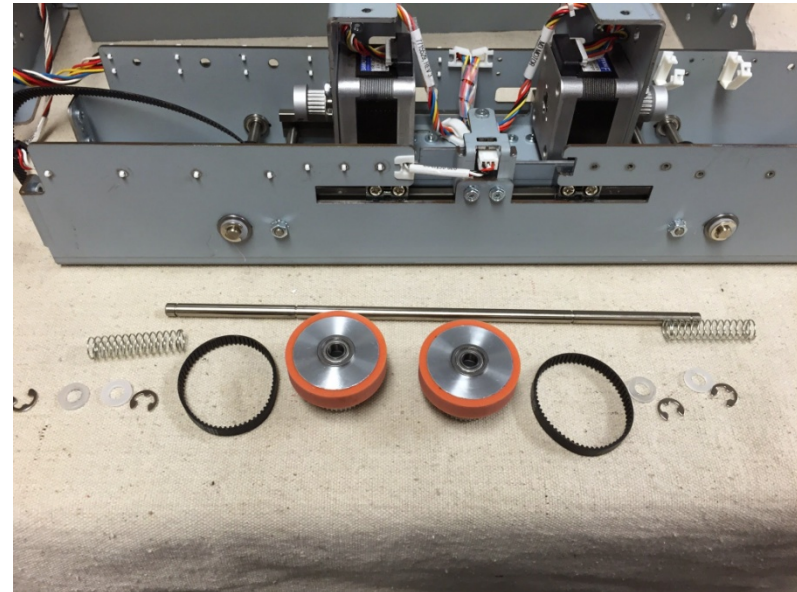

8. Remove Align Home Sensor Bracket sub assembly by removing the screws (2) and its cable.

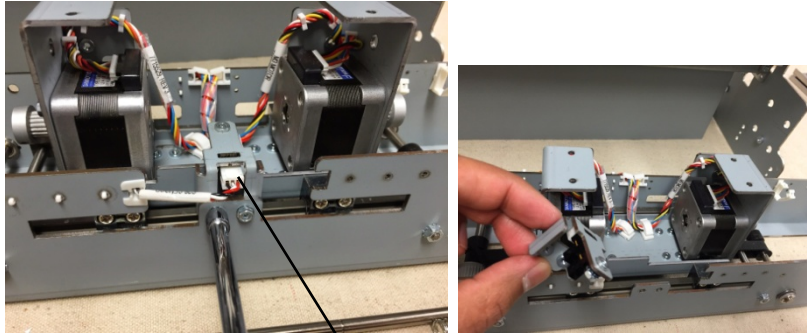

Align Home Sensor Bracket

9. Remove Left and Right Steering Stepper Motors along with their corresponding cables, by removing the Screws (8).

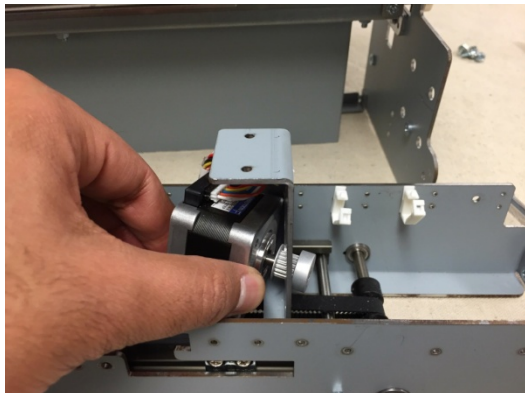
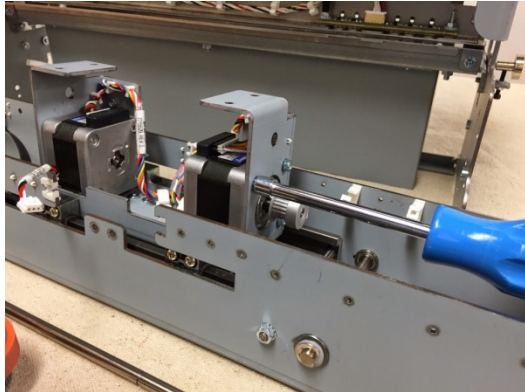

Installation Procedure

1. Install the parts that were removed in the new Alignment Carriage Sub assembly.

Installation tip:

Look at the images for selecting the proper cable for the motors:

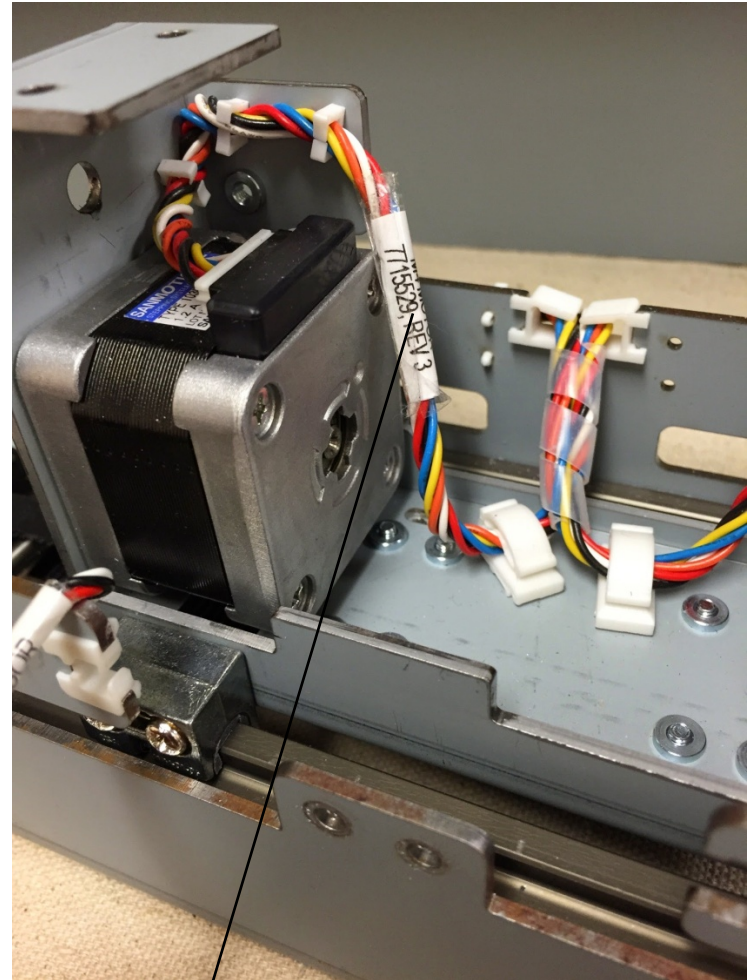

7715529

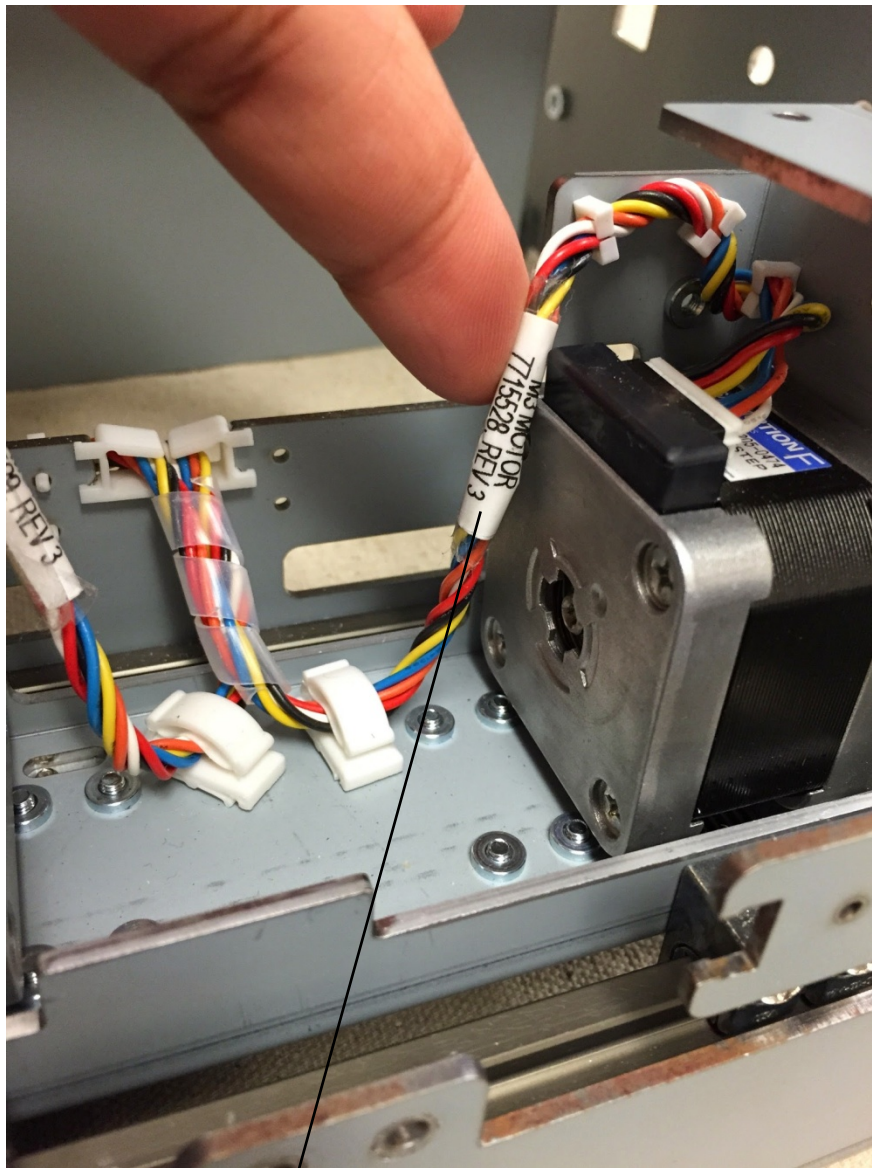

7715528

2. Do ARP 3.9 to install the Steering module.
3. Do ARP 3.1.2 to install the Punch Module.
4. Do ARP 1.6 to install the Rear Cover.
5. Connect the Power Cord.

ARP 3.12 Steering Stepper Motor Replacement

PARTS LIST ON PL 4.5

Use this procedure to remove and install the Front/Left Stepper Motor (M3) or the Rear/Right Stepper Motor (M4).

Removal Procedure

WARNING

Do not perform Repair activities with the power on or electrical power supplied to the machine. Some machine components contain dangerous electrical voltages that can result in electrical shock and possible serious injury.

1. Disconnect the Power Cord.
2. Do ARP 1.6 to remove the Rear Cover.
3. Do ARP 3.1 to remove the Punch Module.
4. Do ARP 3.9 to remove the Steering Module.

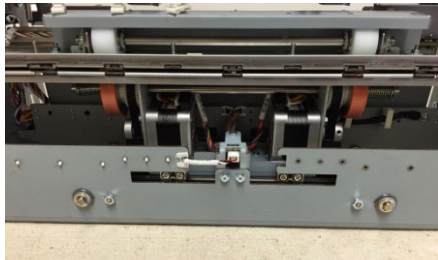

Note: There is no need to remove the Steering module if you have a screwdriver or a 5.5mm nut driver that will reach the (4) screws through the opening in the punch frame.

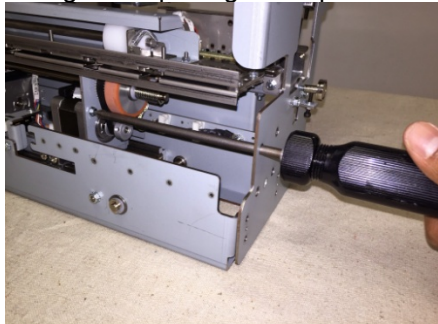

However to remove the rear side steering motor, Alignment stepper motor sub-assembly needs to be removed- ARP 3.8

5. Disconnect the Steering Motor Cable at the Motor and at the Header,

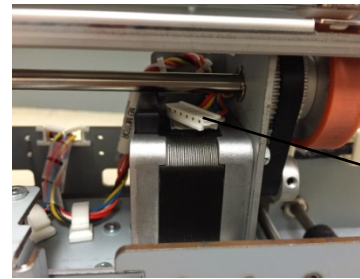

Steering Motor Cable

6. Remove the M3 Screws (2) and the Align Home Sensor Bracket to create more room.

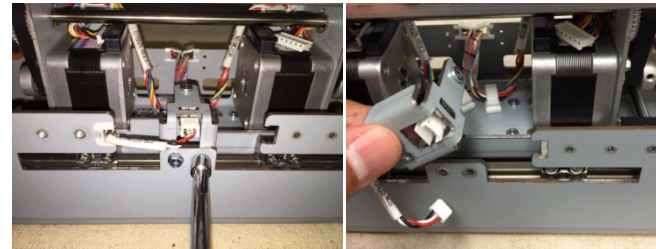

7. Remove the M3 Phillips Head Screws (4).

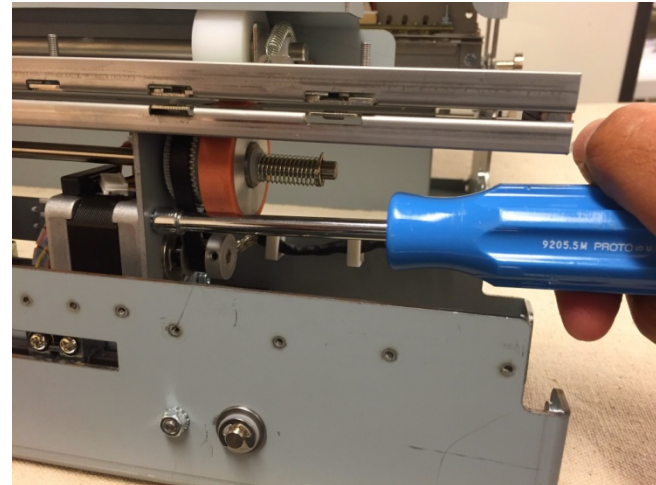

8. Remove the Motor.

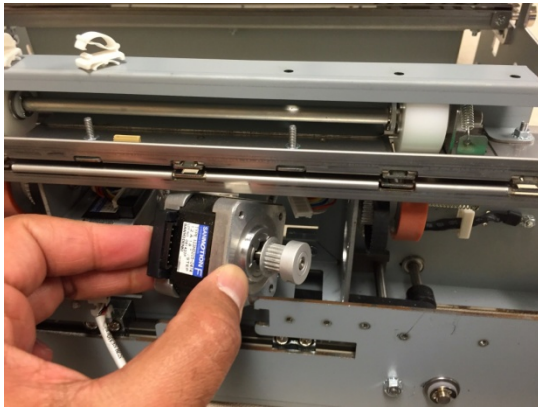

Installation Procedure

1. Place the new Motor in positions and tighten the Screws (4).
2. Connect the Steering Motor Cable at the Motor and at the Header.
3. Install the Screws (4) and tighten with the Belt in place making the belt tension uniform between both sides.
4. Install the Align Home Sensor Bracket and tighten the M3 Screws (2).
5. Do ARP 3.9 to install the Steering Module.
6. Do ARP 3.1 to install the Punch Module.
7. Do ARP 1.6 to install the Rear Cover.
8. Connect the Power Cord.

ARP 3.13 Steering Motor Belt (65 Groove) Replacement

PARTS LIST ON PL 4.5

Use this procedure to remove and install a 65 Groove Steering Belt, the Steering Drive Roller Assembly or the Steering Drive Roller Spring.

Removal Procedure

WARNING

Do not perform Repair activities with the power on or electrical power supplied to the machine. Some machine components contain dangerous electrical voltages that can result in electrical shock and possible serious injury.

1. Disconnect the Power Cord.
2. Do ARP 1.6 to remove the Rear Cover.
3. Do ARP 3.1 to remove the Punch Module.

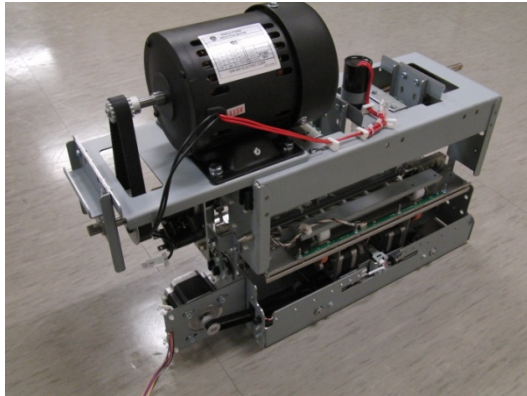

4. Remove the E-Ring from the Steering Drive Roller shaft from the side that needs to be replaced and the two e-rings in side the bracket.

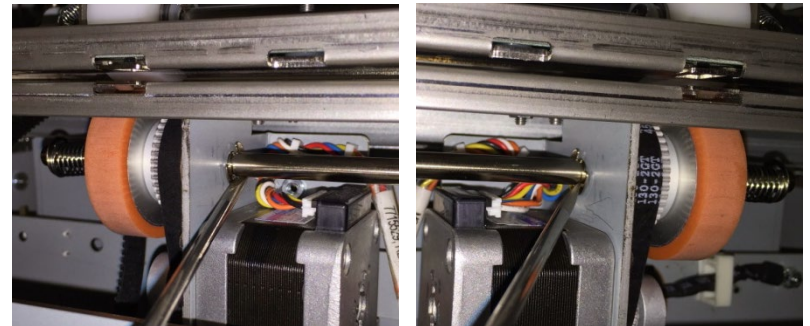
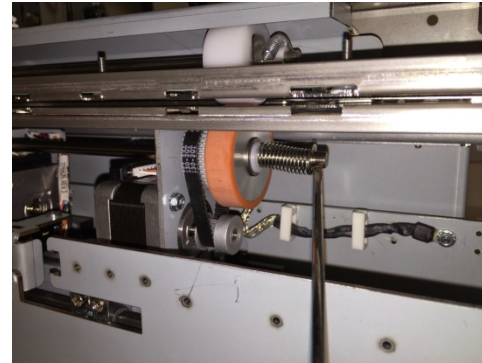

5. Slide the Shaft in the opposite direction so that the Steering Drive Roller Spring, (2) plastic washers and Steering Drive Roller can be removed (from the side that needs the part replaced).

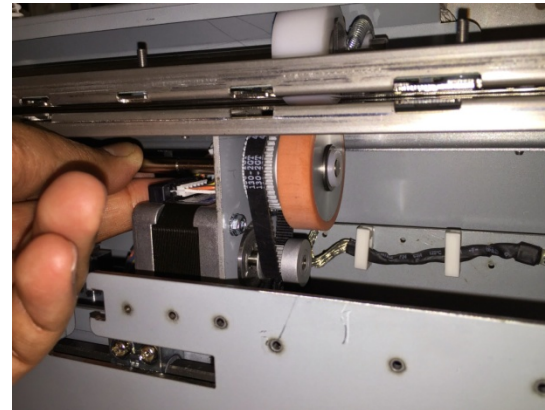

With the above parts removed, one or more of the below parts can be replaced:

- 65 Groove Steering Belt
- Steering Drive Roller
- Steering Drive Roller Spring.

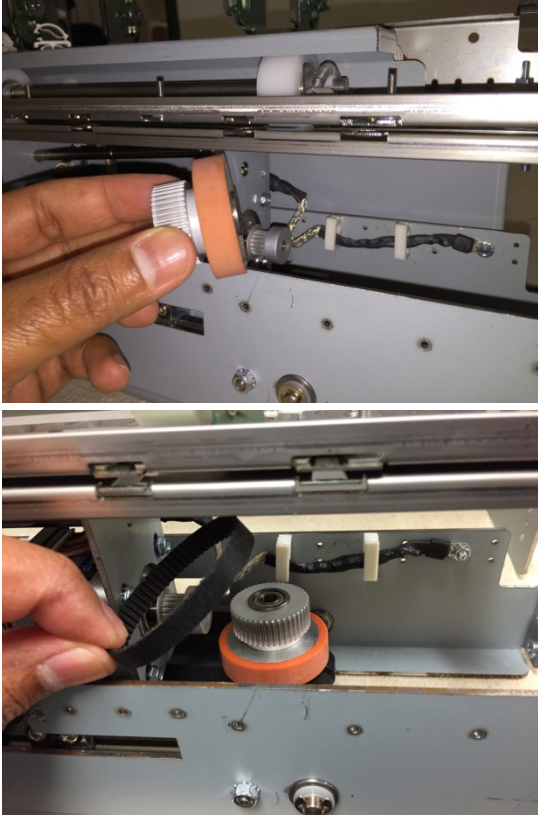

Intallation Procedure

1. Place the belt around the Timing Pulley.
2. Install the Steering Drive Roller and the Flat Washers (2), and the Spring on the end of the Shaft.
3. Install the E-Rings on the Steering Drive Roller Shaft.
4. Do ARP 3.1 to install the Punch Module.
5. Do ARP 1.6 to install the Rear Cover.
6. Connect the Power Cord.

ARP 3.14 Steering Drive Roller Shaft Replacement

PARTS LIST ON PL 4.5

Use this procedure to remove and install the Steering Drive Roller Shaft.

WARNING

Do not perform Repair activities with the power on or electrical power supplied to the machine. Some machine components contain dangerous electrical voltages that can result in electrical shock and possible serious injury.

1. Disconnect the Power Cord.
2. Do ARP 1.6 to remove the Rear Cover.
3. Do ARP 3.1 to remove the Punch Module.

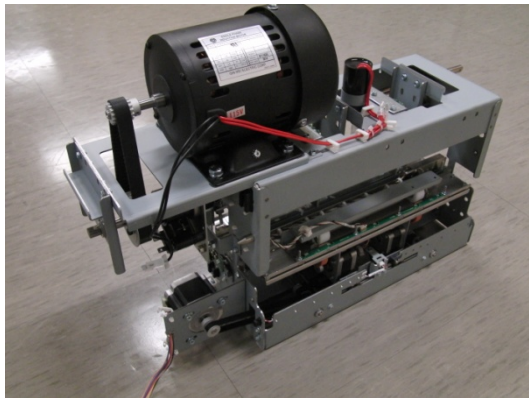

4. Do ARP 3.9 to remove the Steering Module.

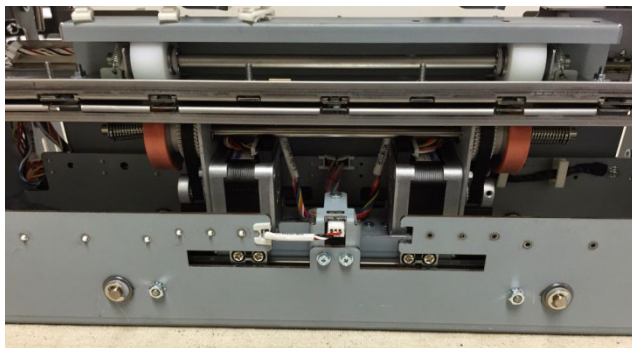

5. Remove the E-Rings (2), the Spring, the Steering Drive Roller and the Flat Washers (2) from each end of the Shaft.

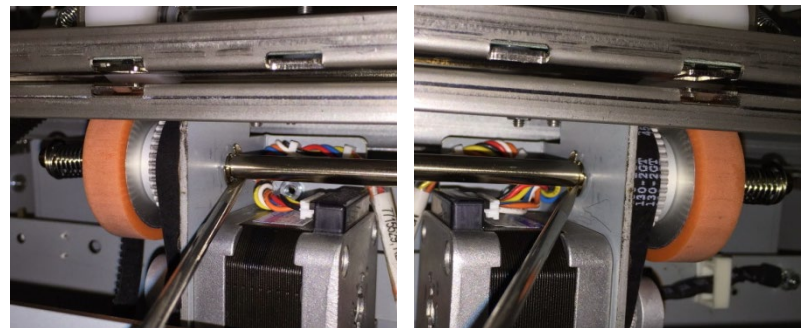
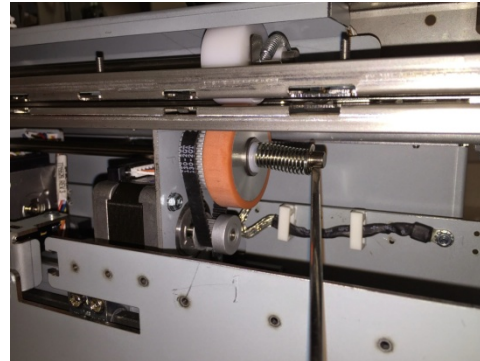

6. Remove the Shaft from the Drive Panel Steering Sub Assembly.

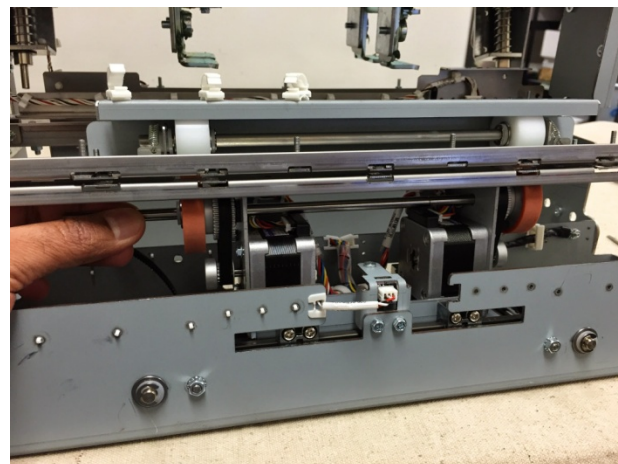

7. Place the new Shaft into the Drive Panel Steering Sub Assembly.
8. Install the E-Rings (2), Spring, Steering Drive Roller and the Flat Washers (2) on each end of the Shaft.
9. Do ARP 3.9 to install the Steering Module.
10. Do ARP 3.1 to install the Punch Module.
11. Do ARP 1.6 to install the Rear Cover.
12. Connect the Power Cord.

ARP 3.15 Steering Idler Panel Weldment Replacement

PARTS LIST ON PL 4.4

Use this procedure to remove and install a Steering Idler Panel Weldment.

Removal Procedure

WARNING

Do not perform Repair activities with the power on or electrical power supplied to the machine. Some machine components contain dangerous electrical voltages that can result in electrical shock and possible serious injury.

1. Disconnect the Power Cord.
2. Do ARP 1.6 to remove the Rear Cover.
3. Do ARP 3.1 to remove the Punch Module.

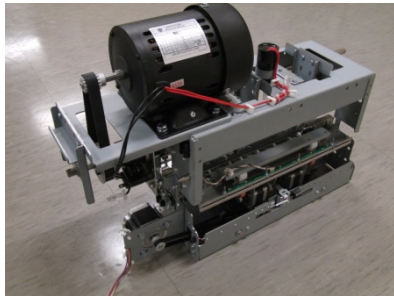

4. Unplug the Skew Sensor and release the Cable Clamp.

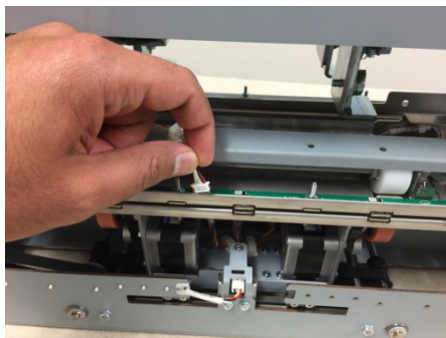

5. Remove the Screws (4) that hold the Steering Idler Panel Sub Assembly to the Drive Panel Steering Sub Assembly.

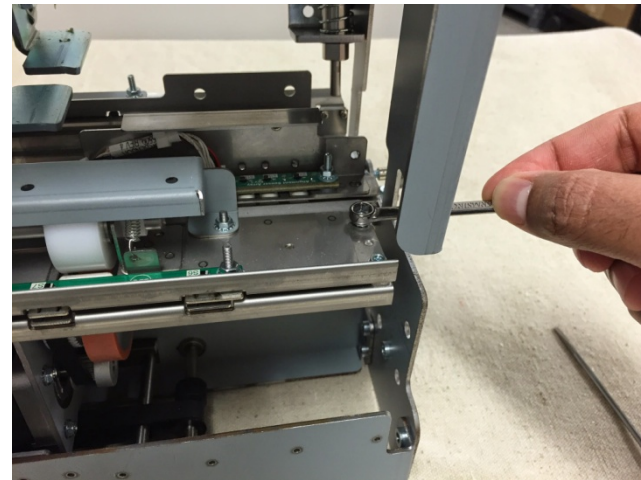

6. Remove the Steering Idler Panel Sub Assembly.

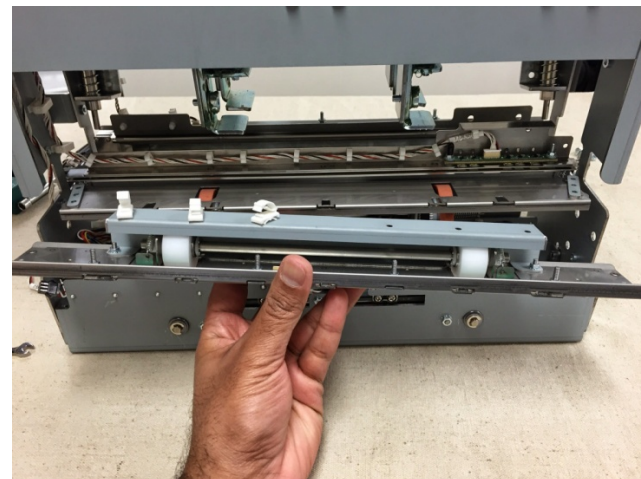

7. Be sure not to lose the spacers on either end of the drive panel.

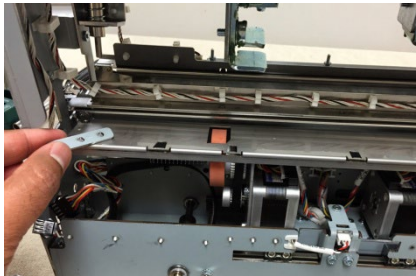

8. Transfer the Skew Sensor, Steering Idler Roller, Idler roller Cover, and all fasteners to the new Weldment.

Note: There is one nylon washer below and above the sensor board at each of the four locations.

Installation Procedure

1. Make sure the Spacers (2) are in position on the Steering Drive Panel Weldment (use semi perfs for placement).
2. Place the Steering Idler Panel Sub Assembly in position on the Drive Panel Steering Sub Assembly.
3. Install the Screws (4).
4. Do ARP 3.1 to install the Punch Module.
5. Do ARP 1.6 to install the Rear Cover.
6. Connect the Power Cord.

ARP 3.16 Steering Idler Roller Assembly Replacement

PARTS LIST ON PL 4.4

Use this procedure to remove and install a Steering Idler Roller Assembly.

Removal Procedure

WARNING

Do not perform Repair activities with the power on or electrical power supplied to the machine. Some machine components contain dangerous electrical voltages that can result in electrical shock and possible serious injury.

1. Disconnect the Power Cord.
2. Do ARP 1.6 to remove the Rear Cover.
3. Do ARP 3.1 to remove the Punch Module.

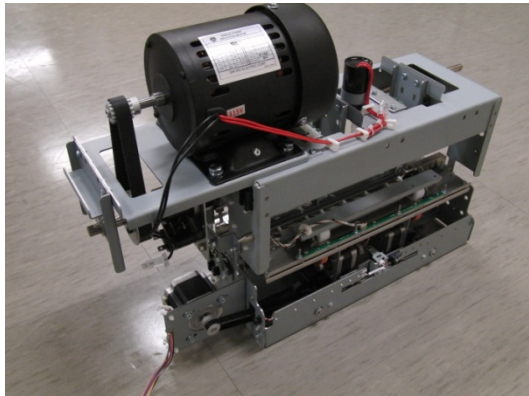

4. Disconnect the Skew Sensor Board Connector.

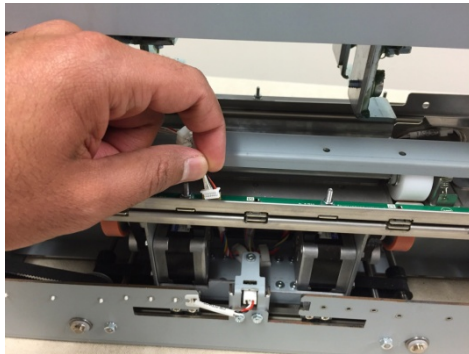

5. Release the Cable Clamp and move the Cable out of the way.
6. Remove the M4 Nuts (2).

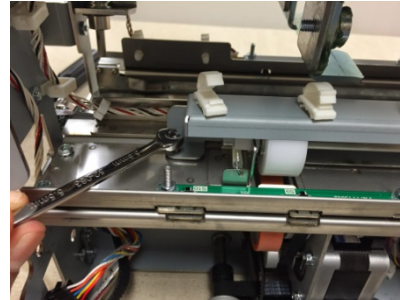

7. Remove the Roller Cover.

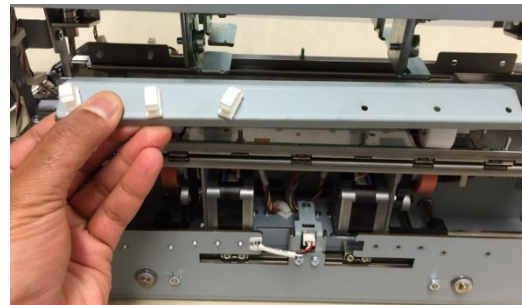

8. Gently move the Springs (2) off the ends of the Roller.

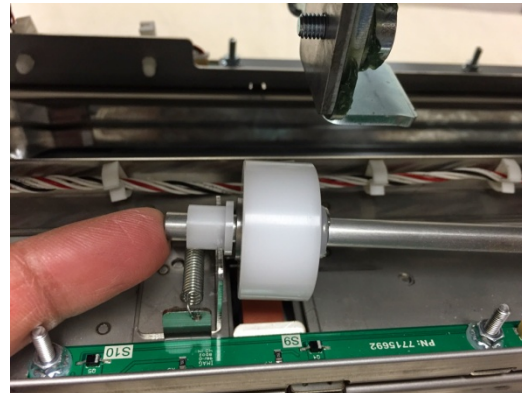

9. Remove the Roller Assembly.

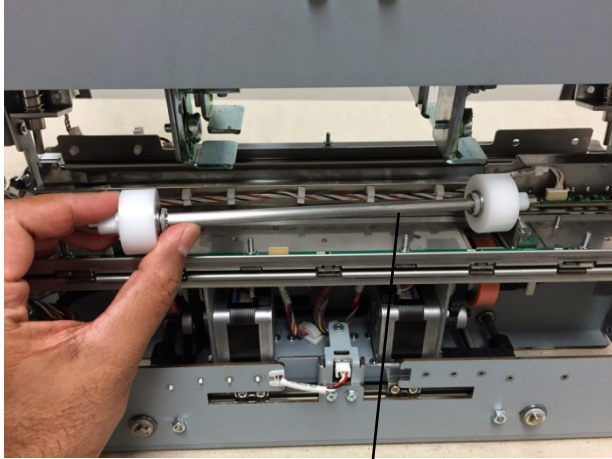

Steering Idler Roller Assembly

Installation Procedure

1. Place the new Roller Assembly in position.
2. Gently move the Springs (2) on to the ends of the Roller.

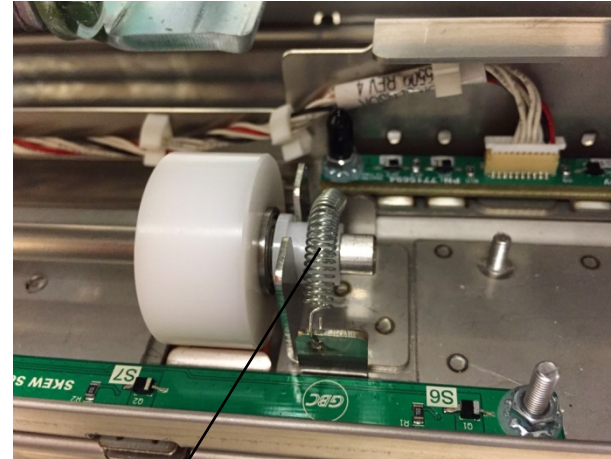

Spring

3. Ensure the Springs (2) are over the white Roller Bushings (2).
4. Place the Roller Cover in position.
5. Install and tighten the M4 Nuts (2).
6. Place the Skew Sensor Board Cable in the Cable Clamp and close the Cable Clamp.
7. Connect the Skew Sensor Board Connector.
8. Do ARP 3.1 to install the Punch Module.
9. Do ARP 1.6 to install the Rear Cover.
10. Connect the Power Cord.

ARP 3.16.1 **Steering Idler Roller Bearing Replacement**

PARTS LIST ON PL 4.4

Use this procedure to remove and install a Steering Idler Roller Double "D" Flange Bearing.

WARNING

Do not perform Repair activities with the power on or electrical power supplied to the machine. Some machine components contain dangerous electrical voltages that can result in electrical shock and possible serious injury.

1. Do ARP 3.16 Steering Idler Roller Replacement to remove the Steering Idler Roller.

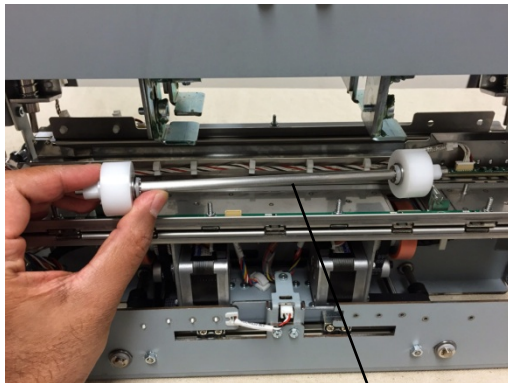

Steering Idler Roller Assembly

2. Remove the Steering Idler Roller Bearing (2) from the ends of Shaft on the Steering Idler Roller Assembly.

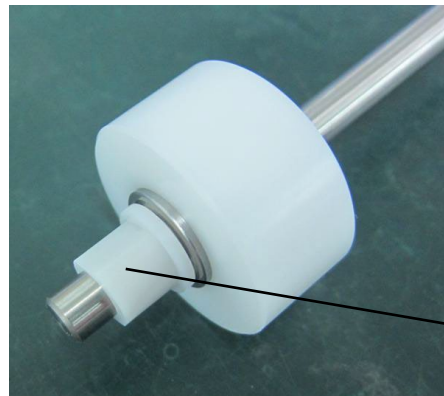

Steering Idler Roller Bearing

3. Place the new Steering Idler Roller Bearing (2) on to the ends of Shaft on the Steering Idler Roller Assembly.
4. Do ARP 3.16 Steering Idler Roller Replacement to install the Steering Idler Roller.

ARP 3.17 Steering Drive Panel Weldment Replacement

PARTS LIST ON PL 4.5

Use this procedure to remove and install the Steering Drive Panel Weldment.

WARNING

Do not perform Repair activities with the power on or electrical power supplied to the machine. Some machine components contain dangerous electrical voltages that can result in electrical shock and possible serious injury.

Removal Procedure

1. Disconnect the Power Cord.
2. Do ARP 1.6 to remove the Rear Cover.
3. Do ARP 3.15 (through step 6) to remove the Steering Idler Panel Sub Assembly.

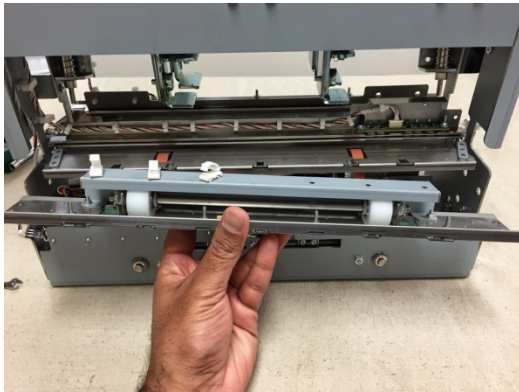

4. Remove the Spacers (2).

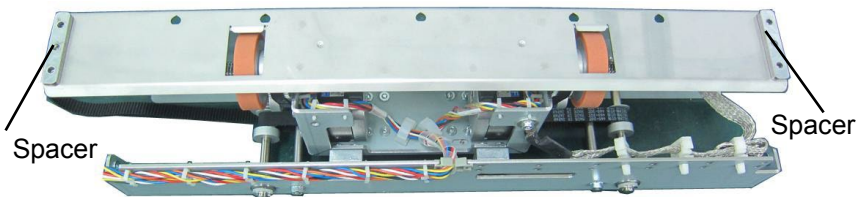

5. Remove the Nuts (4) holding the Steering Drive Panel Weldment.

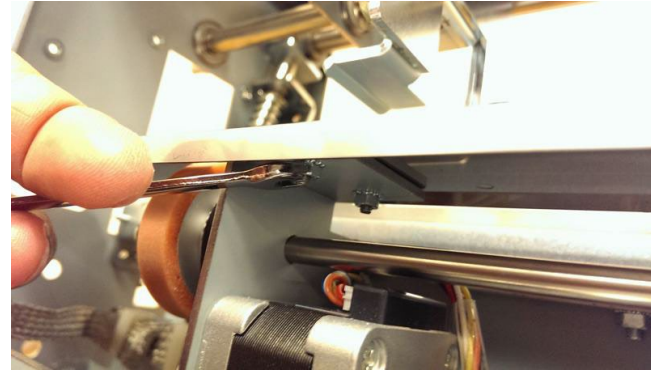

6. Replace with new part

Installation Procedure

1. Place the Steering Drive Panel Weldment in place.
2. Tighten the Nuts (4) that hold the Steering Drive Panel Weldment.
3. Install the Spacers (2).
4. Do ARP 3.15 to install the Steering Idler Panel Sub Assembly.
5. Do ARP 1.6 to install the Rear Cover.
6. Connect the Power Cord.

ARP 3.18 Die Lock Plunger and Stripper Assembly Replacement

PARTS LIST ON PL 4.1

Use this procedure to remove and install the Die Lock Plunger and Stripper Assembly or the Die Lock Bracket.

Removal Procedure

WARNING

Do not perform Repair activities with the power on or electrical power supplied to the machine. Some machine components contain dangerous electrical voltages that can result in electrical shock and possible serious injury.

1. Disconnect the Power Cord.
2. Do ARP 1.6 to remove the Rear Cover.
3. Do ARP 3.1 to remove the Punch Module.

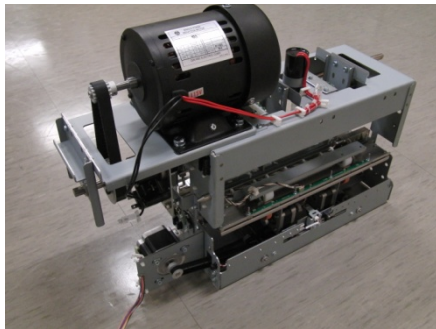

4. Remove the left or right Die Lock Bracket Screws (2).

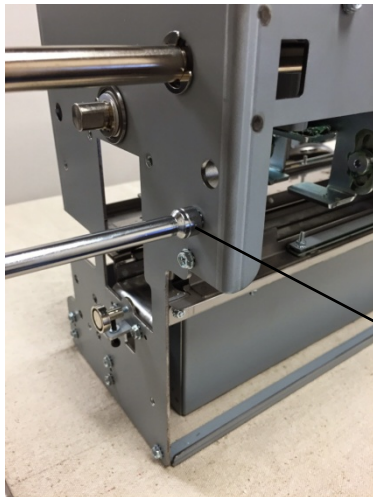

Screws (2)

5. Note the orientation of the Stripper Pad.

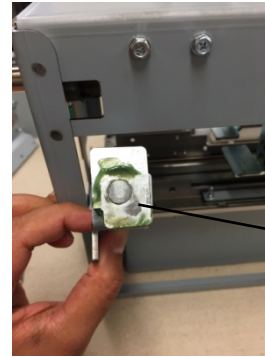

Stripper Pad

6. To replace the components in the Die Lock Plunger and Stripper,

- Remove the E-Clip



E-Clip

- Pull the Die Lock Plunger and Stripper out.

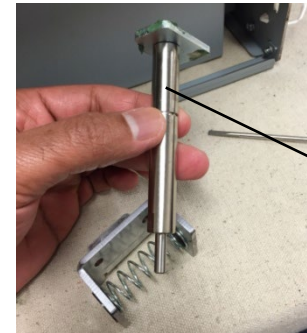

Die Lock
Plunger
and
Stripper

7. Install the Plunger and Stripper Assy.
8. Do ARP 3.1 to install the Punch Module.
9. Do ARP 1.6 to install the Rear Cover.
10. Connect the Power Cord.

ARP 3.19 Punch shaft Ball Bearing Replacement

PARTS LIST ON PL 4.1

Use this procedure to remove and install the Ball Bearing on the punch shaft

WARNING

Do not perform Repair activities with the power on or electrical power supplied to the machine. Some machine components contain dangerous electrical voltages that can result in electrical shock and possible serious injury.

1. Disconnect the Power Cord.
2. Do ARP 1.6 to remove the Rear Cover.



Ball Bearing
Nylon Washer
E-Ring

3. Remove the E-Ring.
4. Remove the Nylon Washer.
5. Remove the Ball Bearing.
6. Place the new Ball Bearing in position.
7. Place the Nylon Washer in position.
8. Place the E-Ring in position.
9. Do ARP 1.6 to install the Rear Cover.
10. Connect the Power Cord.

ARP 3.20 Die Stop Magnet Replacement

PARTS LIST ON PL 4.1

Use this procedure to remove and install the Die Set Magnet.

1. Disconnect the Power Cord.
2. Loosen the Nut and Lock Screw.



3. Rotate the Die Set Magnet counterclockwise and remove it from the Shaft.



4. Place the new Die Set Magnet on the Shaft and rotate it clockwise.
5. Do ADJ 1.3 Die Stop Magnet Adjustment
6. Connect the Power Cord.

ARP 3.21 Die Lock Handle Replacement

PARTS LIST ON PL 4.1

Use this procedure to remove and install the Die Stop Handle.

1. Disconnect the Power Cord.
2. Open the Front Door.

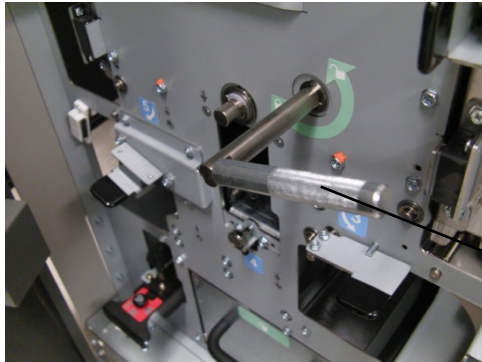

Die Lock Handle

3. Remove the Phillips Screw and the Die Stop Handle.
4. Place the new Die Stop Handle in position and tighten the Phillips Screw.
5. Close the front Door.
6. Connect the Power Cord.

ARP 3.22 Die Lock Shaft Replacement

PARTS LIST ON PL 4.1

Use this procedure to remove and install the Die Lock Shaft.

Removal Procedure

WARNING

Do not perform Repair activities with the power on or electrical power supplied to the machine. Some machine components contain dangerous electrical voltages that can result in electrical shock and possible serious injury.

1. Remove the Die Set (see Operator Manual).
2. Press the Power Switch to the off position.
3. Disconnect the Power Cord.
4. Do ARP 1.6 to remove the Rear Cover.
5. Do ARP 3.1 to remove the Punch Module.

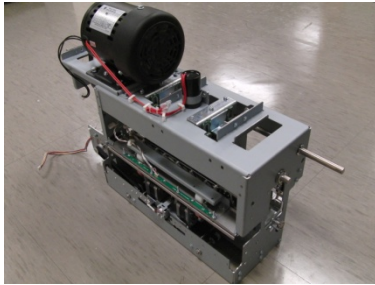

6. Remove the Shoulder Screw from the hole in the Shaft at the rear of the Punch Module.

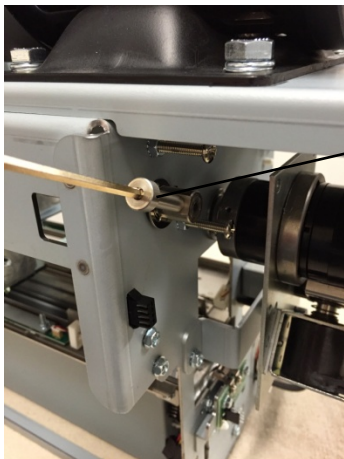

Shoulder Screw

7. Remove the Socket Head Cap Screw and Split Lock Washer from the Cam and the Shaft at the rear of the Punch Module.

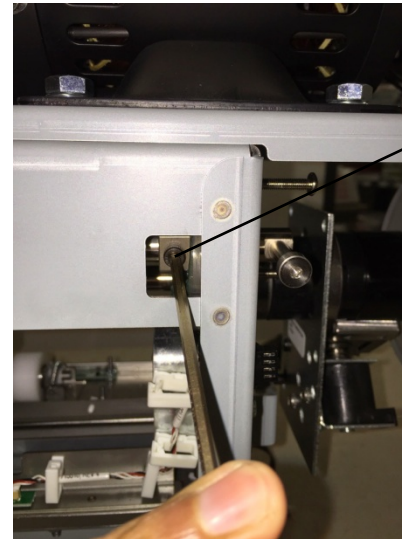

Screw

8. Remove the Socket Head Cap Screw and Split Lock Washer from the Cam and the Shaft at the front of the Punch Module.

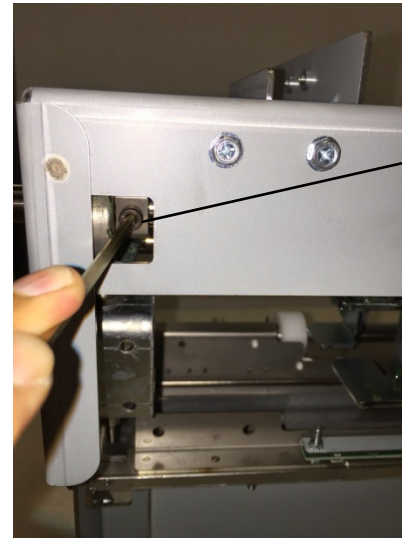

Screw

9. Remove the E-Ring from the Shaft at the rear of the Punch Module.



E-Ring

10. Remove the E-Ring from the Shaft at the front of the Punch Module.



E-Ring

11. Pull the Shaft out through the Cams (2) and out of the Punch Module.

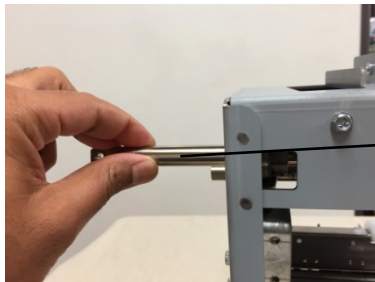

Shaft

3. Push the Shaft through the Punch Module, through the hole in the other Cam, and out through the hole in the rear of the front of the Punch Module (cam portin against side Frame)
4. Insert the E-Ring on the Shaft at the front of the Punch Module.
5. Insert the E-Ring on the Shaft at the rear of the Punch Module.
6. Insert the Socket Head Cap Screw and Split Lock Washer into the Cam and the Shaft at the front of the Punch Module.
7. Insert the Phillips Screw into the Cam and the Shaft at the rear of the Punch Module.
8. Insert the Shoulder Screw the hole in the Shaft at the rear of the Punch Module. Make sure it is in the correct phase (Shoulder Screw facing down as well as Cam Screws facing down).

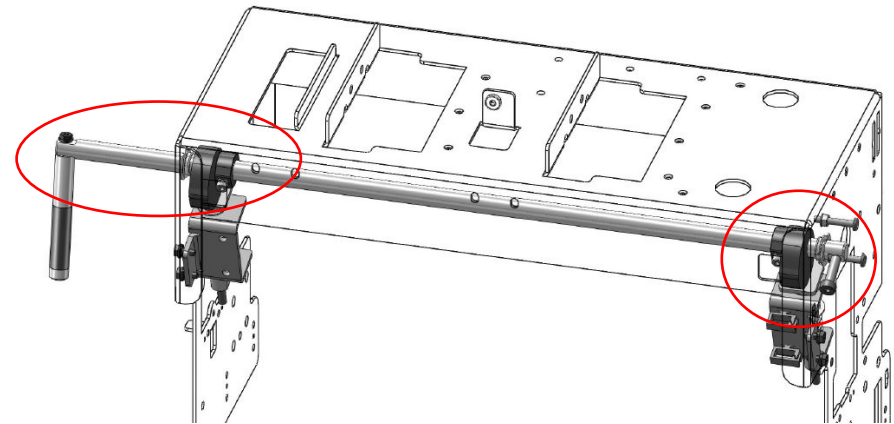

9. Do ARP 3.1 to install the Punch Module.
10. Insert the Die Lock Handle into the Shaft at the front of the Punch Module, and tighten the Screw.
11. Do ARP 1.6 to install the Rear Cover.
12. Connect the Power Cord.

Installation Procedure

1. Place a Die Lock Cam inside the Punch Module by the hole at the front of the Punch Module (cam portion against side Frame).
2. Insert the Die Lock Shaft through the hole at the front of the Punch Module and through the hole in the Cam.

ARP 3.23 Die Rail Assembly and Die Rail Springs Replacement PARTS LIST ON PL 4.10

Removal Procedure

Use this procedure to remove and install the Die Rail Assembly and Die Rail Springs

WARNING Do not perform Repair activities with the power on or electrical power supplied to the machine. Some machine components contain dangerous electrical voltages that can result in electrical shock and possible serious injury.

1. Disconnect the Power Cord.
2. Do ARP 1.6 to remove the Rear Cover.
3. Do ARP 3.1 to remove the Punch Module.
4. Do ARP 3.24 to remove the Alignment sensor bracket and Alignment Sensor bottom guide.
5. Unplug Back Gage Sensor Board and release the wires from cable clamps.

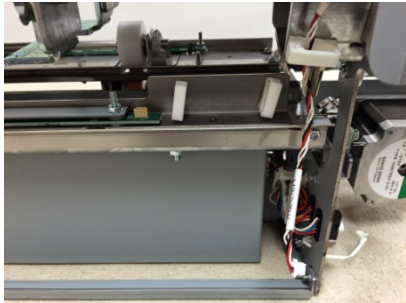

6. Remove the Screws (2) that hold the Dieset Recognition Bracket.

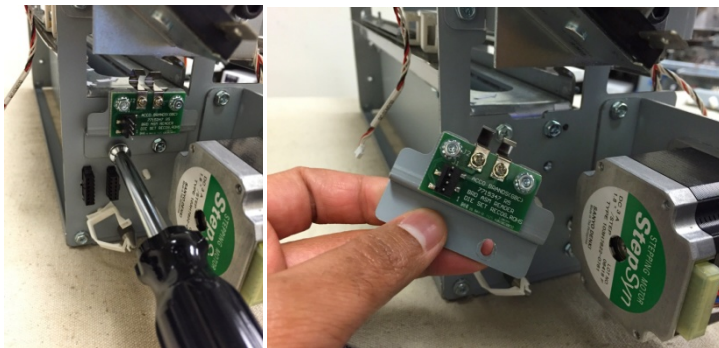

7. Remove the (2) Screws from the front and (2) screws from the back that hold that Die Rail Assembly.

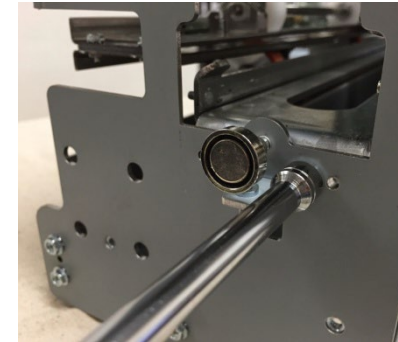

8. Remove the Die Rail Assembly.

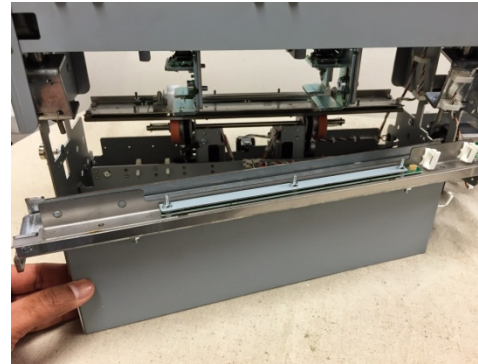

9. Die rail springs can be replaced at this point by unscrewing M2 screws (4) and M2 lockwashers (4). If you are replacing only the springs, go to Installation procedure.



10. Remove the backgage sensor upper and lower brackets.

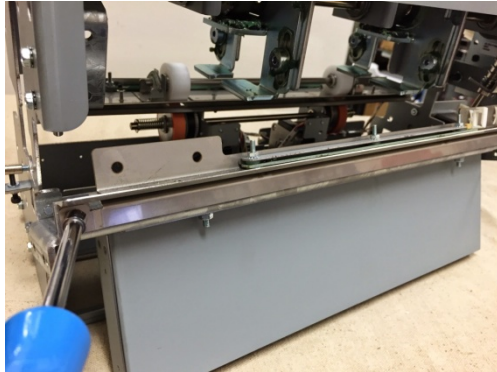

11. Remove Nuts (3) and the Chip Chute.



12. Remove the old Die Rail.

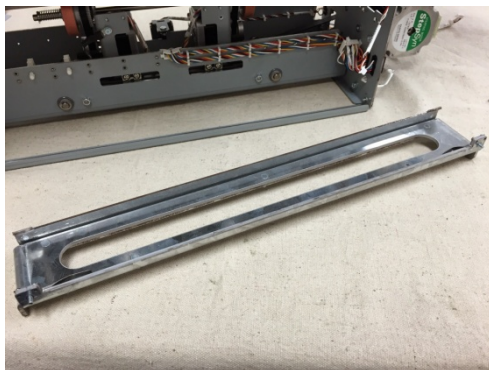

Installation Procedure

1. Place the new Die Rail Assembly in position.
2. Place the Chip Chute in position and tighten the Nuts (3).
3. Place the Springs (2) in position, install the M2 Lock Washers (4), and tighten the the M2 Screws (4).
4. Install the backgage upper and lower brackets
5. Place the the Die Rail Assembly in position.
6. Install and tighten the Screws (4) that hold that Die Rail Assembly.
When installing (4) screws that hold the die rail, use 3mm reference holes for positioning the part. A 3mm pin can be inserted to hold the part in position while the screw is tightened.

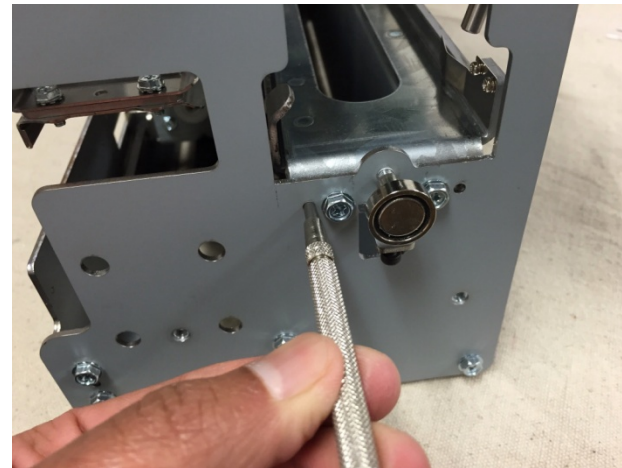

7. Tighten the Screws (2) that hold the Dieset Recognition Bracket.
8. Install the upper and lower Alignment sensor brackets.
9. Connect the Back Gage Sensor Board and place the wires in the Cable Clamps.
10. Do ARP 3.1 to install the Punch Module.
11. Do ADJ 1.6 Die set recognition board adjustment.
12. Do ARP 1.6 to install the Rear Cover.
13. Connect the Power Cord.

ARP 3.24 Alignment Sensor Bracket and Alignment Sensor Bottom Guide Replacement

PARTS LIST ON PL 4.10

Removal Procedure

Use this procedure to remove and install the Alignment Sensor Bracket and the Alignment Sensor Bottom Guide.

WARNING

Do not perform Repair activities with the power on or electrical power supplied to the machine. Some machine components contain dangerous electrical voltages that can result in electrical shock and possible serious injury.

1. Disconnect the Power Cord.
2. Do ARP 1.6 to remove the Rear Cover.
3. Do ARP 3.1 to remove the Punch Module.
4. Unplug the Skew Sensor Connector and release the Cable from the Cable Clamps.

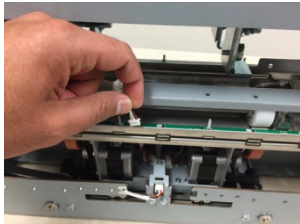

5. Remove the Steering Idler Roller Cover.

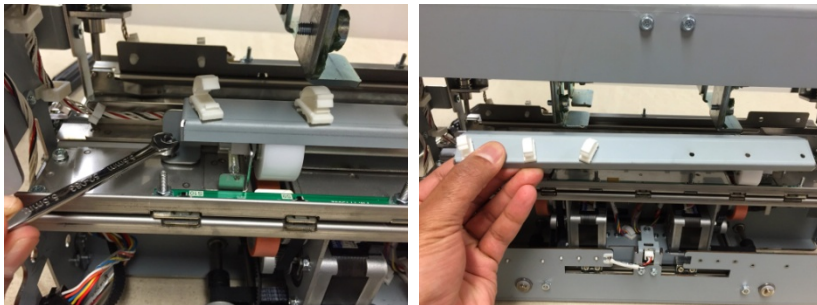

6. Unplug the Alignment Sensor Connector

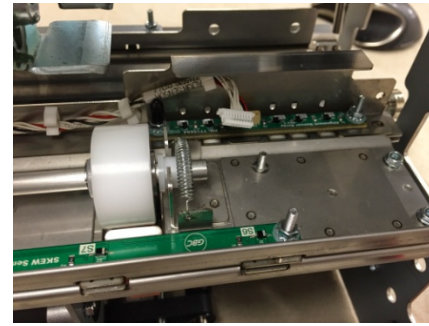

7. Remove M3 Nuts (2) that hold the Brackets.

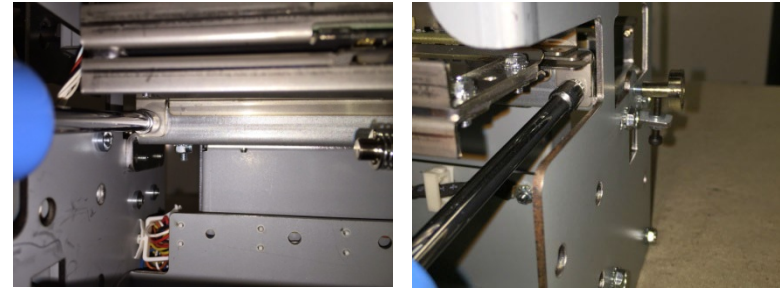

8. Remove both upper and lower brackets as shown, do not pull on the Align sensor wires.

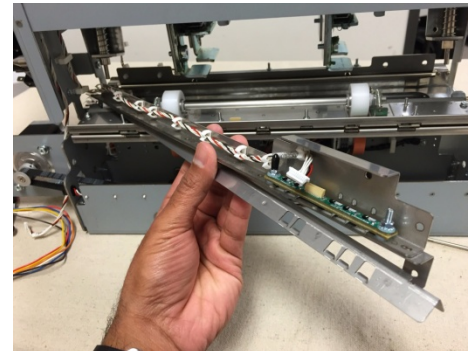

9. The lower bracket can be replaced at this time.

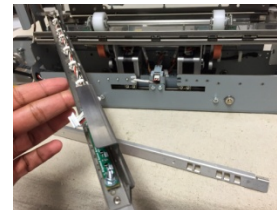

10. To replace the upper bracket, remove the cable clamps, cable, Alignment sensors, washers, nuts from the old bracket and transfer them to the new bracket.

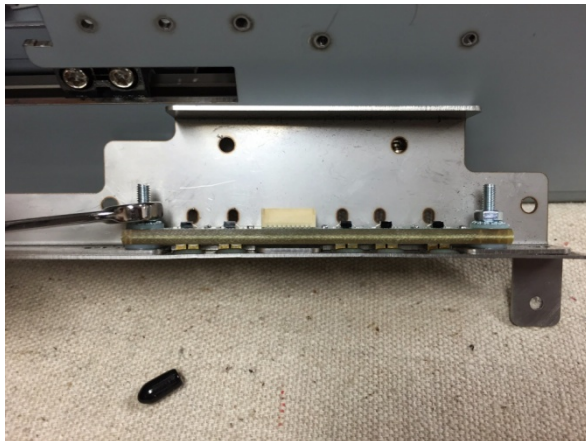
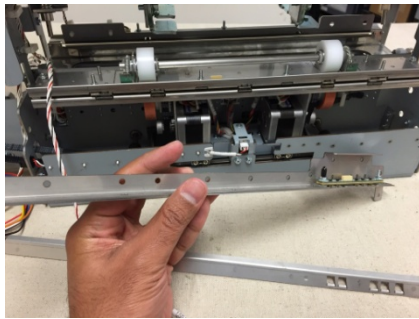
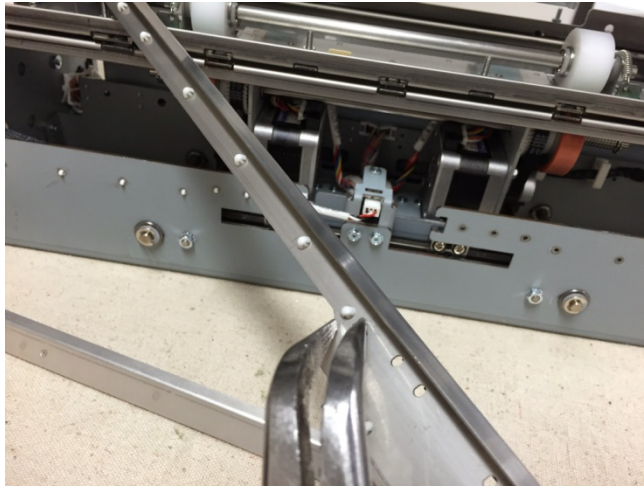

Installation Procedure

1. Replace the bracket so the lower bracket (Alignment Sensor bottom guide) will overlap the top bracket when assembled.
2. Insert both Brackets and position them.
3. Install and tighten the M3 Nuts (2) that hold the Brackets.
4. Connect the Alignment Sensor Connector, and place the Cable in the Cable Clamps.
5. Install the Steering Idler Roller Cover.
6. Connect the Skew Sensor Connector and place the Cable in the Cable Clamps.
7. Do ARP 3.1 to install the Punch Module.
8. Do ARP 1.6 to install the Rear Cover.
9. Connect the Power Cord.

ARP 3.25 Punch Module Mount Pin Replacement

PARTS LIST ON PL 4.1

Use this procedure to remove and install the Punch Module Mount Pins.

WARNING

Do not perform Repair activities with the power on or electrical power supplied to the machine. Some machine components contain dangerous electrical voltages that can result in electrical shock and possible serious injury.

1. Disconnect the Power Cord.
2. Do ARP 1.6 to remove the Rear Cover.
3. Do ARP 3.1 to remove the Punch Module.
4. Remove the Screw and the Mount Pin.

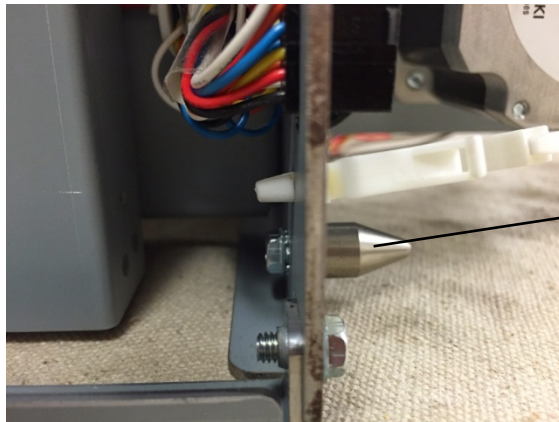

Mount Pin

5. Place the new Mount Pin in position and tighten the Screw.
6. Do ARP 3.1 to install the Punch Module.
7. Close the Front Door.
8. Do ARP 1.6 to install the Rear Cover.
9. Connect the Power Cord.

ARP 3.26 Backgage Sensor Bracket Weldment and Backgage Sensor Lower Bracket Replacement

PARTS LIST ON PL 4.10

Use this procedure to remove and install the Backgage Sensor Bracket Weldment and Backgage Sensor Lower Bracket.

WARNING

Do not perform Repair activities with the power on or electrical power supplied to the machine. Some machine components contain dangerous electrical voltages that can result in electrical shock and possible serious injury.

Removal Procedure

1. Disconnect the Power Cord.
2. Do ARP 1.6 to remove the Rear Cover.
3. Do ARP 3.1 to remove the Punch Module.
4. Remove the M3 Nuts (2) that hold both the Brackets.

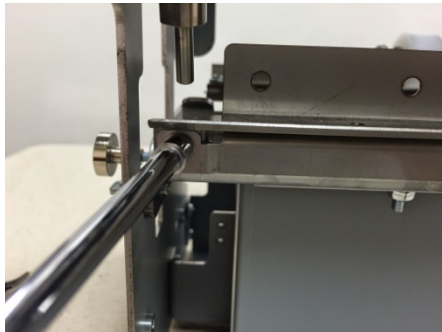

5. If replacing only the lower bracket, replace the Bracket then go to the installation procedure.
6. Unplug the Backgage Sensor and release the wires from the Cable Clamps.

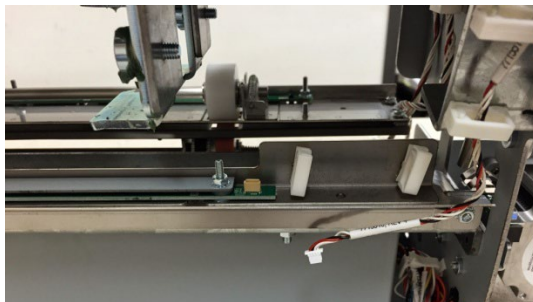

7. Transfer the Backgage Sensor and all fasteners to the new part.

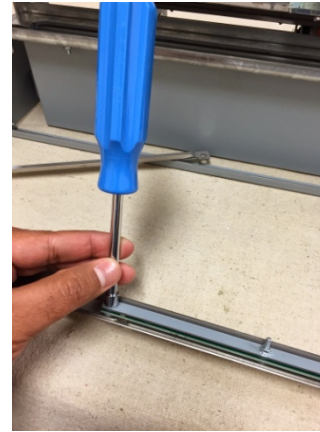

Installation Procedure

1. Place the Brackets in position so the lower bracket overlaps the upper bracket.
2. Connect the Backgage Sensor and place the wires in the Cable Clamps.
3. Tighten the M3 Nuts (2) that hold both the Brackets.
4. Do ARP 3.1 to install the Punch Module.
5. Do ARP 1.6 to install the Rear Cover.
6. Connect the Power Cord.

ARP 3.27 Die Set Recognition Replacement

PARTS LIST ON PL 4.9

Use this procedure to remove and install the Die Set Recognition Assembly.

Removal Procedure

WARNING

Do not perform Repair activities with the power on or electrical power supplied to the machine. Some machine components contain dangerous electrical voltages that can result in electrical shock and possible serious injury.

1. Disconnect the Power Cord.
2. Do ARP 1.6 to remove the Rear Cover.
3. Disconnect the Die Set Recognition Cable.

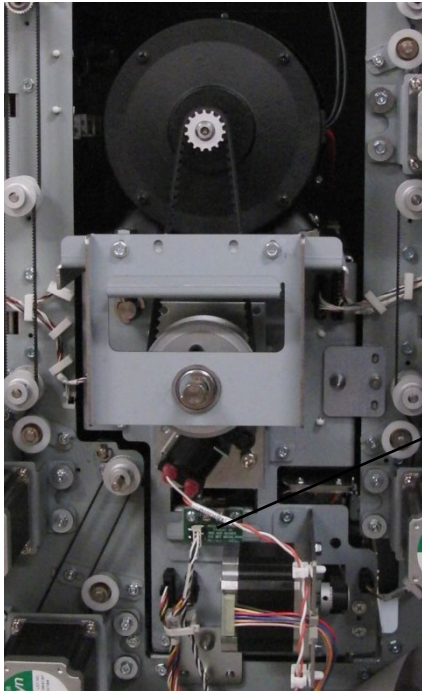

Die Set
Recognition Cable

(Cont.)

4. Remove the Screws (2) and the Die Set Recognition Board Mount Bracket.



Screws (2)

Die Set Recognition
Bracket

5. Place the new Die Set Recognition Board Mount Bracket in position and tighten the Screws (2).
6. Connect the Die Set Recognition Cable.
7. Do ARP 1.6 to install the Rear Cover.
8. Do ADJ 1.6 Die Set Recognition board adjustment procedure.
9. Connect the Power Cord.

4. Power Supply

ARP 4.1 24V Power Supply Replacement

PARTS LIST ON PL 2.5

Use this procedure to remove and install the 24V Power Supply Assembly.

Removal Procedure

WARNING

Do not perform Repair activities with the power on or electrical power supplied to the machine. Some machine components contain dangerous electrical voltages that can result in electrical shock and possible serious injury.

1. Disconnect the Power Cord.
2. Do ARP 1.6 to remove the Rear Cover.
3. Disconnect Connectors J1 and J3 from the Main Control Board.

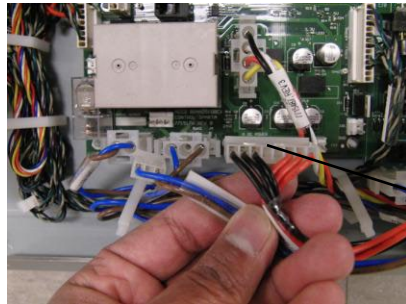

Connector

4. Remove the M4 Screw (1) and remove the Ground Cable from the Power Supply.

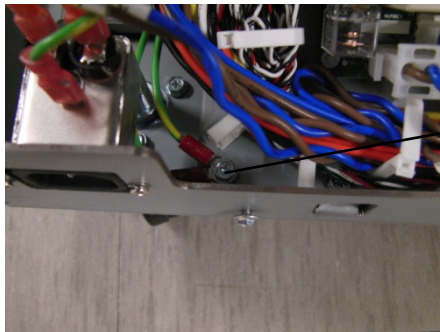

Screw

5. Remove the M4 Screws (4) from the side of the Base Frame.

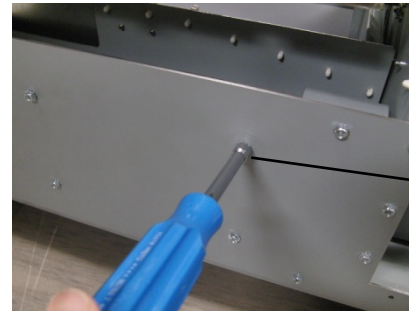

Screws (4)

6. Remove the power supply and the cables through the opening on top. Assist the connectors to get through the grommet while removing. Cable clamps should also be released to free up the cables.



Grommet

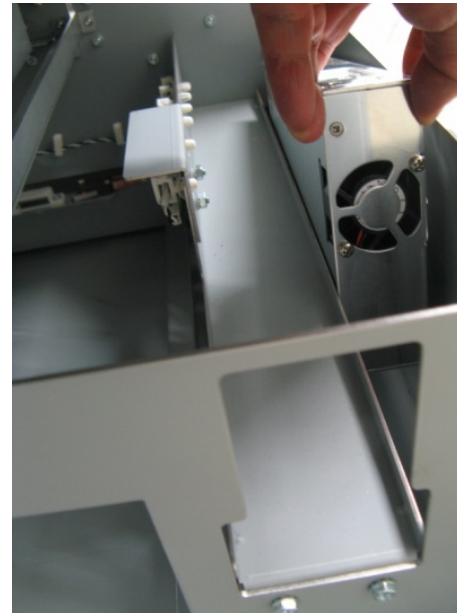

7. Transfer all wires to the new Power Supply.



Installation Procedure

1. Tilt the Power Supply and insert it through the Chip Tray opening.
2. Tighten the M4 Screws (4) on the side of the Base Frame.
3. Place the Ground Cable in position on the Power Supply and tighten the M4 Screw (1).
4. Connect Connectors J1 and J3 to the Main Control Board.
5. Do ARP 1.6 to install the Rear Cover.
6. Connect the Power Cord.

ARP 4.2 AC Filter Replacement

PARTS LIST ON PL 6.1

Use this procedure to remove and install the AC Filter Assembly.

Removal Procedure

WARNING

Do not perform Repair activities with the power on or electrical power supplied to the machine. Some machine components contain dangerous electrical voltages that can result in electrical shock and possible serious injury.

1. Disconnect the Power Cord.
2. Do ARP 1.6 to remove the Rear Cover.
3. Remove the Phillips head Screws (2) and the AC Filter-USB Mount Bracket.

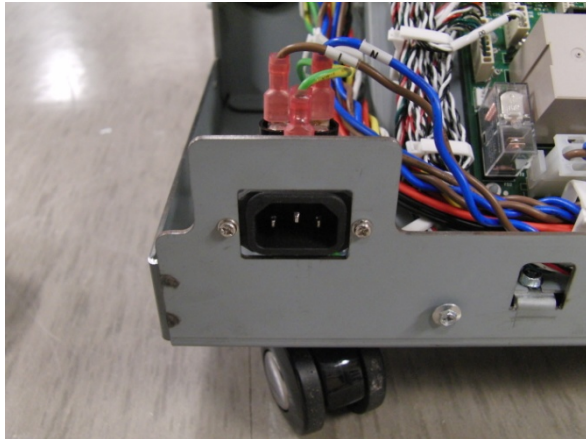

4. Note the location of the wires (3).



5. Remove the Wires (3) and the AC Filter.
6. Place the new AC Filter in position and tighten the Screws (2).
7. Do ARP 1.6 to install the Rear Cover.
8. Connect the Power Cord.

5. Electronics and Control

ARP 5.1 Main Control Board Replacement

PARTS LIST ON PL 6.1

Use this procedure to remove and install the Main Control Board. Before ARPlacing the Main Control board, attempt to retrieve the number of Punch cycles, do GP 6.1.9 Punch Cycles Procedure.

Removal Procedure

WARNING

Do not perform Repair activities with the power on or electrical power supplied to the machine. Some machine components contain dangerous electrical voltages that can result in electrical shock and possible serious injury.

1. Disconnect the Power Cord.
2. Do ARP 1.6 to remove the Rear Cover.
3. Remove the M3 Screws from the Main Control Board and the the Comm Board.

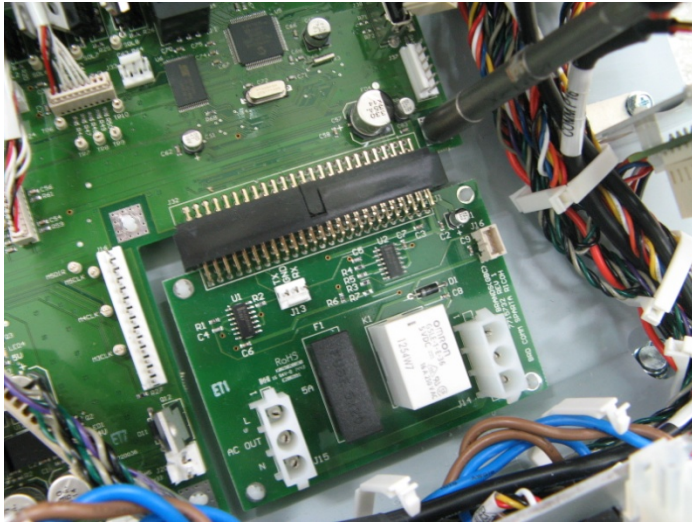

4. Disconnect the Cable Connectors from Main and Comm boards.
5. Remove the old Main Control Board and Comm Board.

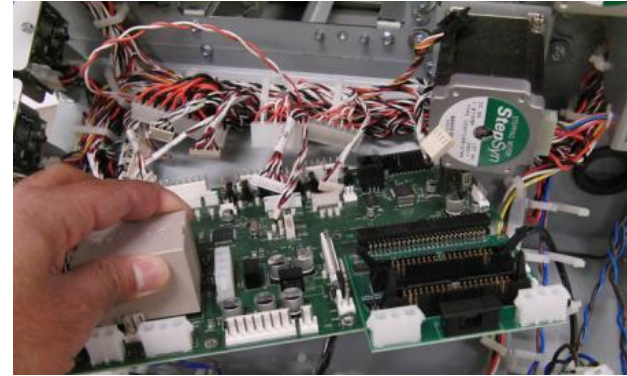

6. Disconnect the plug-in Connector and remove the Comm Board.

Installation Procedure

1. Install the the Comm Board on the Main Control Board using the plug-in connector.
2. Place the new Main Control Board and Comm Board in position
3. Press the Control boards on the plastic standoffs so that it snaps in place (13).
4. Tighten the M3 Screw in the Main Control Board.
5. Connect the Connectors (29).

Refer to the Section 7 Wiring.

The following table lists the connectors starting at the top right and going counterclockwise.

Cable/Wire #	Connector #
771523	J36
7715455	J23
7715467	J19
7715466	J18
7715536	J29
7715451	J21
7715485	J27
7715477	J17
7715473	J15
7715453	J22
7715495	J9
7715468	J14
7715457	J25
7715456	J24
7715476	J2
7715493	J3
7715494	J4
7715487	J8
7715492	J1

Cable/Wire #	Connector #
7715459	J28
7715458	J26
7715267	J20
7715470	J16
775538	J37
7715490	USB Connector
7715537	J12
7715494	J15 COMM Board
7715498	J14 COMM Board
7715726	J16 COMM Board

6. Do ARP 1.6 to install the Rear Cover.
7. Connect the Power Cord.

ARP 5.2 Comm Board Replacement

PARTS LIST ON PL 6.1

Use this procedure to remove and install the Comm Board.

WARNING

Do not perform Repair activities with the power on or electrical power supplied to the machine. Some machine components contain dangerous electrical voltages that can result in electrical shock and possible serious injury.

Removal Procedure

1. Disconnect the Power Cord.
2. Do ARP 1.6 to remove the Rear Cover.
3. Disconnect the Cable Connectors
4. Remove the M3 screws securing the Comm Board. Slide the Comm Board toward the rear of the machine to disconnect it from the Main Board.

Installation Procedure

1. Place the new Comm Board in position by inserting the plug-in connector to the main board and pressing on (4) standoffs until it snaps in place.
2. Connect the Connectors (3).

Cable/Wire #	Connector #
7715498	J14 COMM Board
7715494	J15 COMM Board
7715726	J16 COMM Board

3. Do ARP 1.6 to install the Rear Cover.
4. Connect the Power Cord.

ARP 5.3 Dieset Recognition Reader Board Replacement

PARTS LIST ON PL 4.9

Use this procedure to remove and install the Dieset Recognition Reader Board

WARNING

Do not perform Repair activities with the power on or electrical power supplied to the machine. Some machine components contain dangerous electrical voltages that can result in electrical shock and possible serious injury.

1. Disconnect the Power Cord.
2. Do ARP 1.6 to remove the Rear Cover.
3. Disconnect the Connector at the Dieset Recognition Reader Board.
4. Remove the Screws (2) and the Dieset Recognition Reader Board.

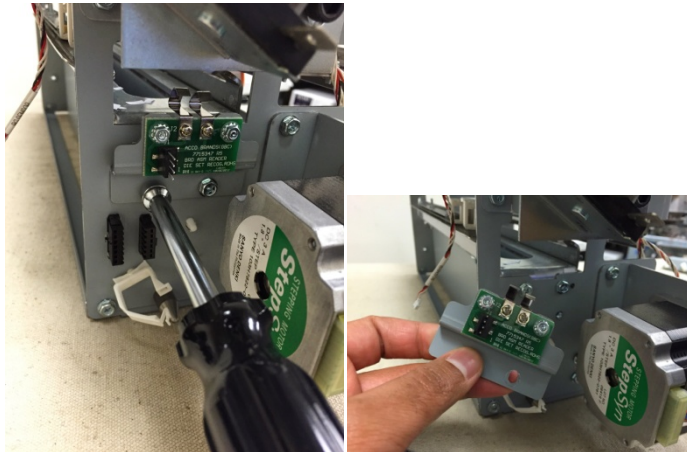

5. Place the Dieset Recognition Reader Board in position and tighten the Screws (2).
6. Connect the Connector to the Dieset Recognition Reader Board.
7. Do ADJ 1.6 *Dieset Recognition Board Adjustment* to set the Dieset Recognition Reader Board.
8. Do ARP 1.6 to install the Rear Cover.
9. Connect the Power Cord.

6. Adjustments

ADJ 1.1 Door Latch Adjustment

PARTS LIST ON PL 1.2

Do the following to ensure the door latch holds the door closed and that the activating bracket tab [1] depresses the door switch[2]. The tab should press the switch button just so that it is close to bottoming out.



WARNING

Do not perform Repair activities with the power on or electrical power supplied to the machine. Some machine components contain dangerous electrical voltages that can result in electrical shock and possible serious injury.

1. Disconnect the Power Cord.
2. Open the Front Door.

3. Loosen the Adjustment Screws (2) on the door latch.

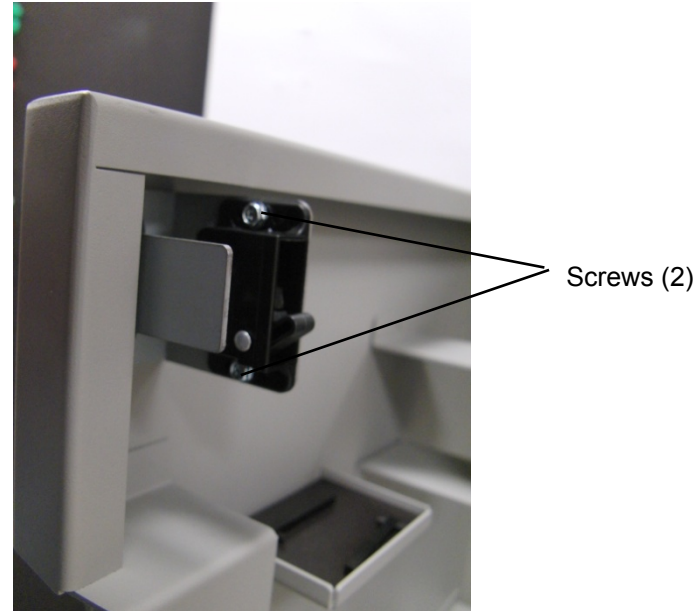

4. Do one of the following:
 - To move the door in, move the latch towards the front of the door.
 - To move the door out, move the latch away from the front of the door.
5. Tighten the Adjustment Screws (2).
6. Close the Front Door.
7. Connect the Power Cord.
8. Test the Door Latch operation.

ADJ 1.2 Diverter Solenoid Adjustment

PARTS LIST ON PL 2.3

Use this procedure to adjust the position of the Diverter Solenoid Assembly.

1. Open the Front Door.
2. Do ARP 1.6 to remove the Rear Cover.
3. With the Interlock cheater inserted, do GP 6.2.6 to actuate SOL1 (L1-Diverter Solenoid). This will switch the diverter gate to punch mode. The Diverter gate will rise and hit the upper bypass panel.

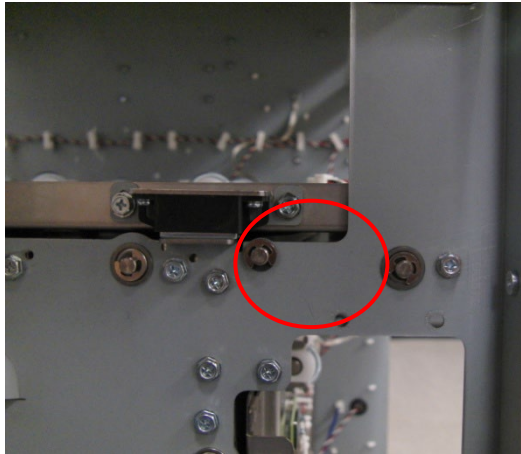

4. When the solenoid is not actuated, it needs to rest on the Diverter limiter bracket. To properly adjust the position of the limiter bracket do the following:

- a. Loosen the Screws (2) that hold the Limiter Bracket.

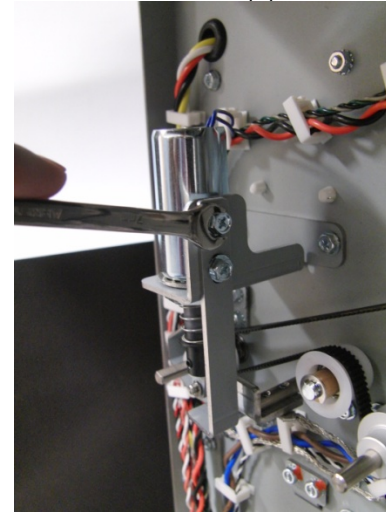

- b. Insert a 0.25 to 0.5mm shim between the Diverter and the Lower Entrance Panel.

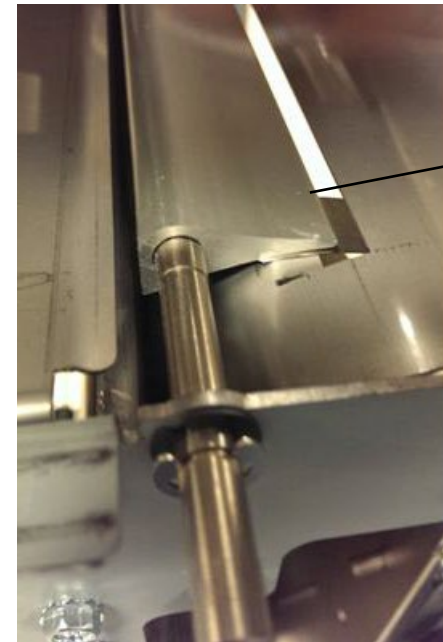

Shim (0.25 to 0.5mm)

- c. Raise the Limiter Bracket so that it just touches the Diverter Link and tighten the Screws (2).

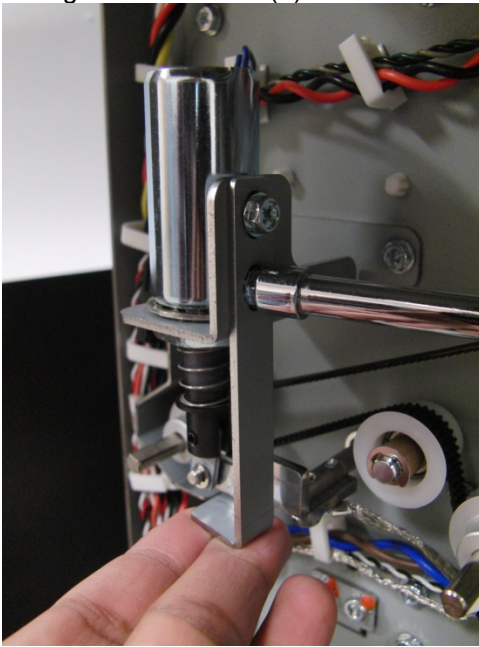

NOTE: Raising the Limiter Bracket too high will position the diverter gate higher, which will obstruct the paper flow and cause jams.

- 5. Check the clearance between the Diverter and the cutout in the Lower Entrance Panel at both sides.

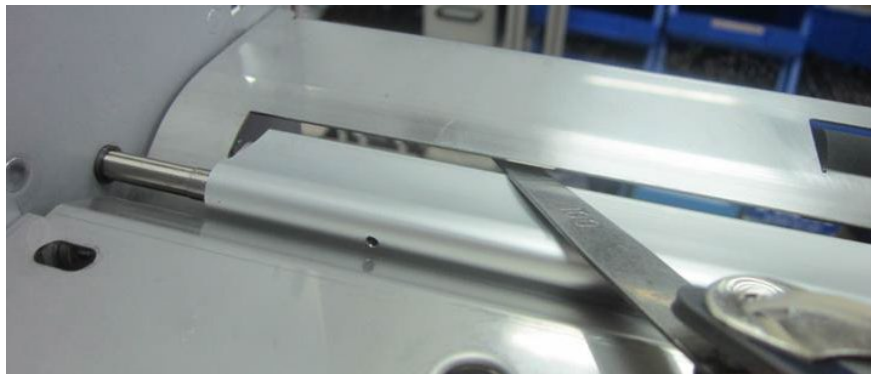

The clearance should be minimum 1.0 mm.

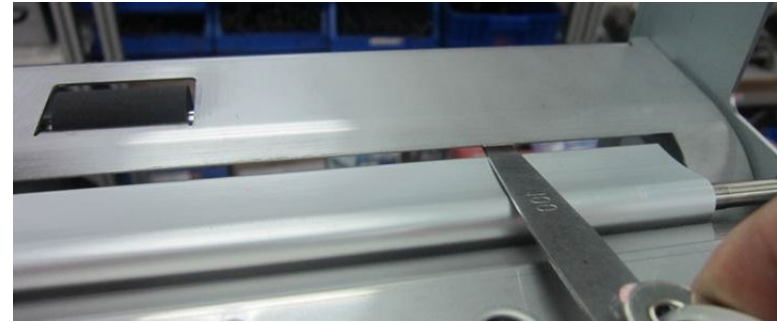

ADJ 1.3 Die Stop Magnet Adjustment

PARTS LIST ON PL 4.1

If the ALIGNMENT MODE Procedure (GP 6.1.2) does not move the inboard/outboard position of the punch holes far enough, use this procedure to adjust the Die Stop Magnet to move the holes inboard/outboard,

Note: The nominal position of the Die stop magnet face is 18.3mm from the face of the Punch module frame

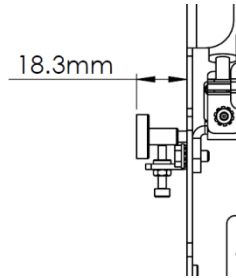

1. Open the Front Door.
2. Remove the Die Set (see Operator Manual).

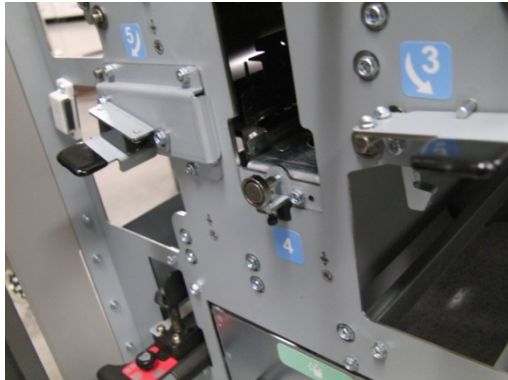

3. Loosen the Nut and Lock Screw.



4. Rotate the Die Set Magnet to adjust the position of the Die Set Stop

- Rotate the Die Set Magnet clockwise to move the hole toward the rear of the Punch.
- Rotate the Die Set Magnet counterclockwise to move the hole toward the front of the Punch.



5. Tighten the Nut and Lock Screw.
6. Run some sheets of paper through the Punch Cycle.
7. Check the Alignment of the holes.
8. If necessary, repeat steps 3-6 until the alignment is centered (iterative process).
9. Install the Die Set (see Operator Manual).
10. Close the front Door.

ADJ 1.4 Timing Belts Adjustment

ADJ 1.4.1 Steering Sub-assembly Belt Adjustment

PARTS LIST ON PL 4.3

Use this procedure to adjust the Steering Sub-assembly Belt tension.

1. Disconnect the Power Cord.
2. Do ARP 1.6 to remove the Rear Cover.
3. Do ARP 3.1 to remove the Punch Module.
4. Loosen the Phillips Screws (4).

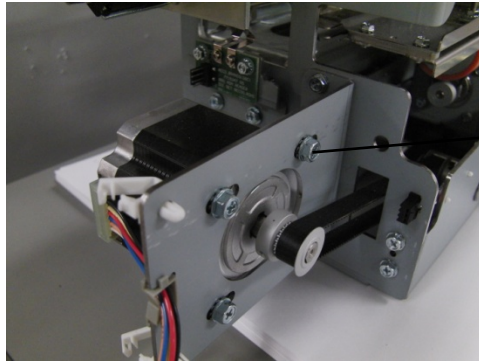

Screws (4)

5. Adjust the belt tension such that there is a deflection of 1~2mm.

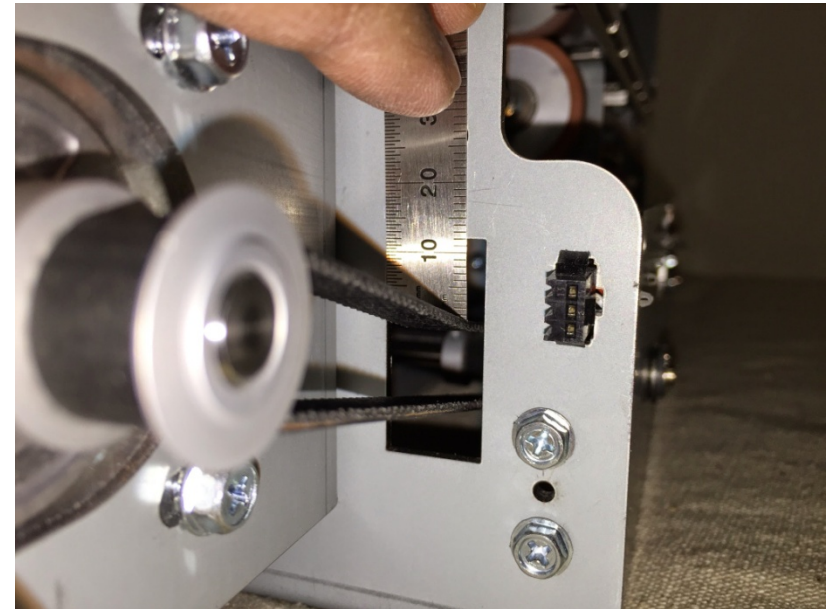
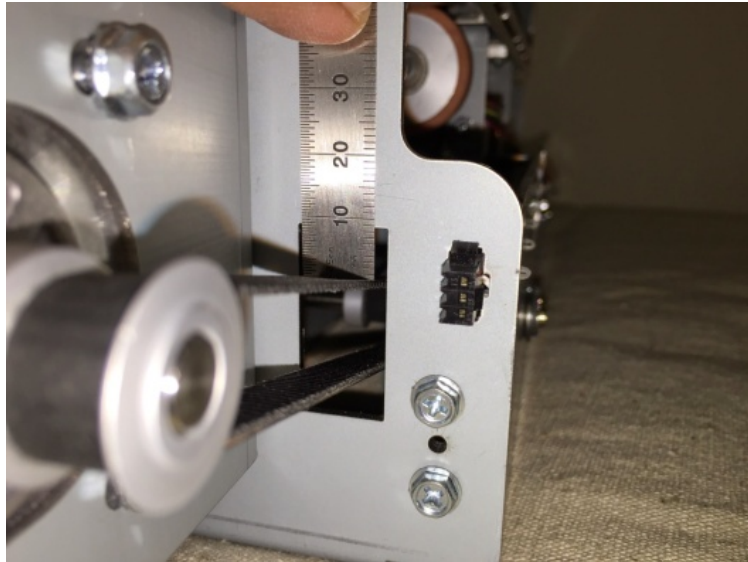

6. Tighten the Phillips Screws (4).
7. Do ARP 3.1 to install the Punch Module.
8. Do ARP 1.6 to install the Rear Cover.
9. Connect the Power Cord.

ADJ 1.4.2 534T belt tension adjustment

Use this procedure to adjust the Belt tension of 534T timing belt.

1. Disconnect the Power Cord.
2. Do ARP 1.6 to remove the Rear Cover.
3. Loosen the the tensioner.

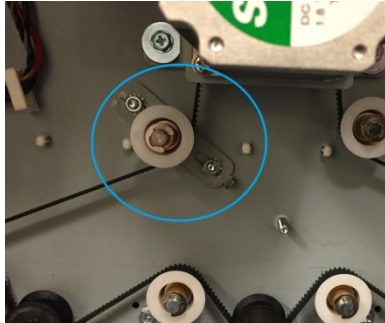

4. Adjust the belt tension such that there is a deflection of 6~8mm.

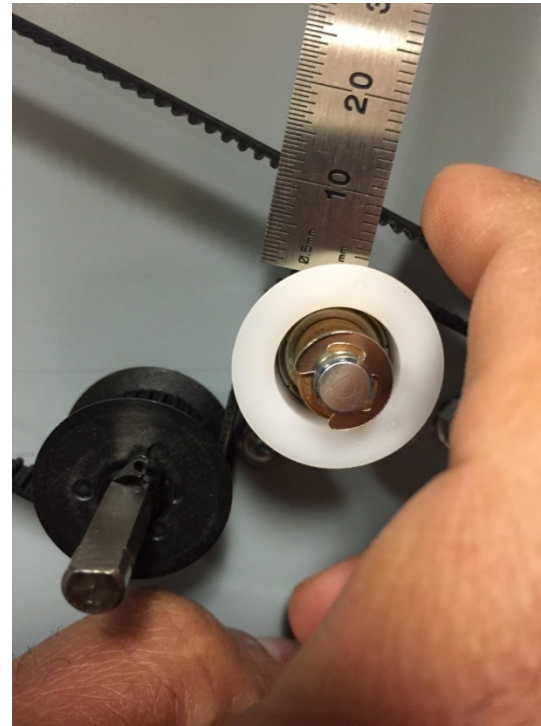

5. Tighten the tensioner
6. Do ARP 1.6 to install the Rear Cover.
7. Connect the Power Cord.

ADJ 1.4.3 134T Belt tension adjustment

Use this procedure to adjust the Belt tension of 134T timing belt.

1. Disconnect the Power Cord.
2. Do ARP 1.6 to remove the Rear Cover.
3. Loosen the the tensioner.



4. Adjust the belt tension such that there is a deflection of 3~5mm.

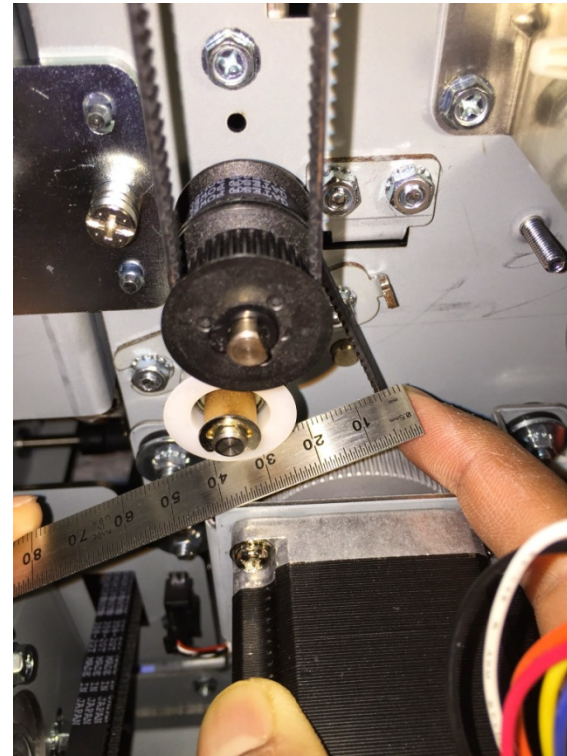
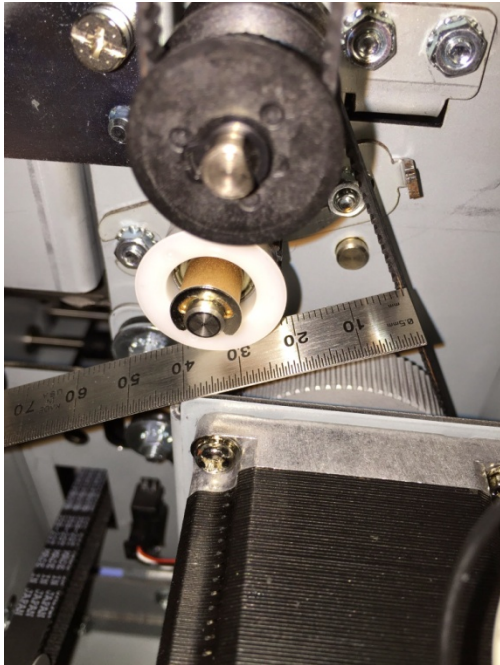

5. Tighten the tensioner
6. Do ARP 1.6 to install the Rear Cover.
7. Connect the Power cord.

ADJ 1.4.4 179T belt tension adjustment

Use this procedure to adjust the Belt tension of 134T timing belt.

1. Disconnect the Power Cord.
2. Do ARP 1.6 to remove the Rear Cover.
3. Loosen the the tensioner.



4. Adjust the belt tension such that there is a deflection of 4~6mm.



5. Tighten the tensioner
6. Do ARP 1.6 to install the Rear Cover.
7. Connect the Power cord.

ADJ 1.4.5 Steering motor belt tension adjustment

Use the below setting for Steering motor belt tension.

Use this procedure to adjust the Steering Sub-assembly Belt tension.

1. Disconnect the Power Cord.
2. Do ARP 1.6 to remove the Rear Cover.
3. Do ARP 3.1 to remove the Punch Module.
4. Loosen the Phillips Screws (4) from the Steering stepper motor.

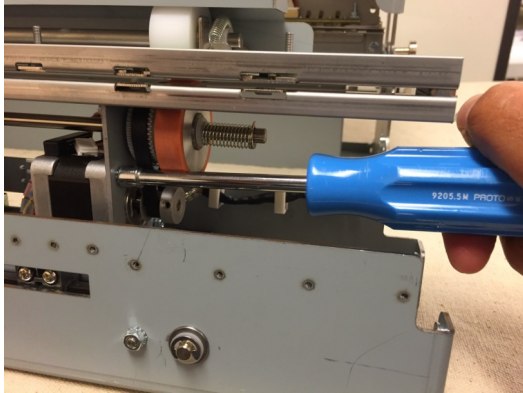

5. Adjust the belt tension such that there is a deflection of 1~2mm.

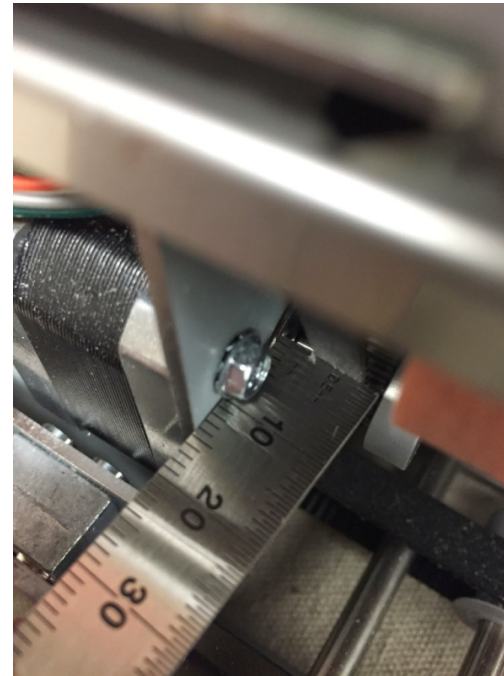
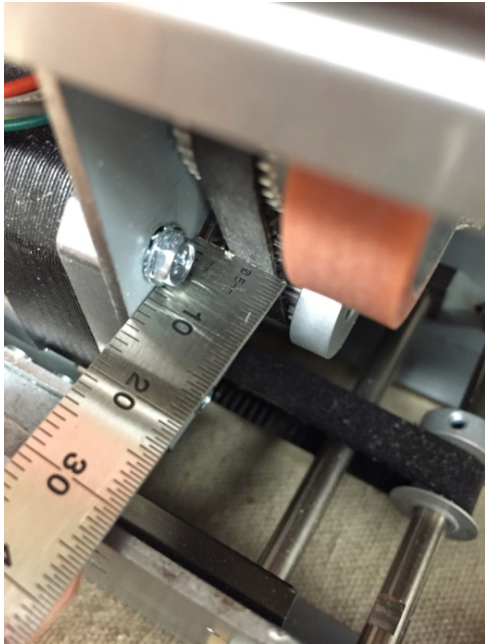

6. Tighten the Phillips Screws (4).
7. Do ARP 3.1 to install the Punch Module.
8. Do ARP 1.6 to install the Rear Cover.
9. Connect the Power Cord.

ADJ 1.5 Punch clutch Indexing

PARTS LIST ON PL 4.8

Use this procedure to bring the punch cam to its home position after each punch cycle. The punch cam should reach its home position to ensure proper paper flow through the die set.

Note: Some designs in the images may be slightly different from those on the machine you are working on but this does not affect the setting procedure.

1. Verify that the punch cam needs to be indexed.

After a punch cycle the flats on the punch shaft have to be horizontal ($\pm 5^\circ$ from horizontal is acceptable). See below for an image of a properly indexed punch shaft.

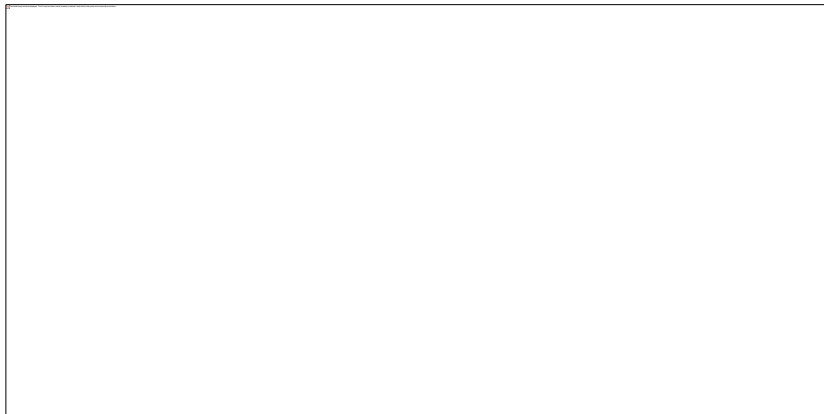

2. If the flats are not horizontal ($\pm 5^\circ$ from horizontal is acceptable), do the following procedure to set the shaft indexed position.

Important note: Punch Shaft/Cam rotates in the Clockwise direction when viewed from the front of the machine.



3. Disconnect the Power Cord.
 4. Do ARP 1.6 to remove the Rear Cover.
 5. Do ARP 3.1 to remove the Punch Module.
- (Cont.)

6. Inspect the punch cam position; the flat on the punch cam (or punch shaft) will indicate how far it has deviated from the horizontal position. In the example below the cam has rotated past the home position by 20°.



7. To index the shaft to the correct position, remove the spring clip from the its groove in the Punch clutch.



8. Continue to move the spring clip towards the pulley.

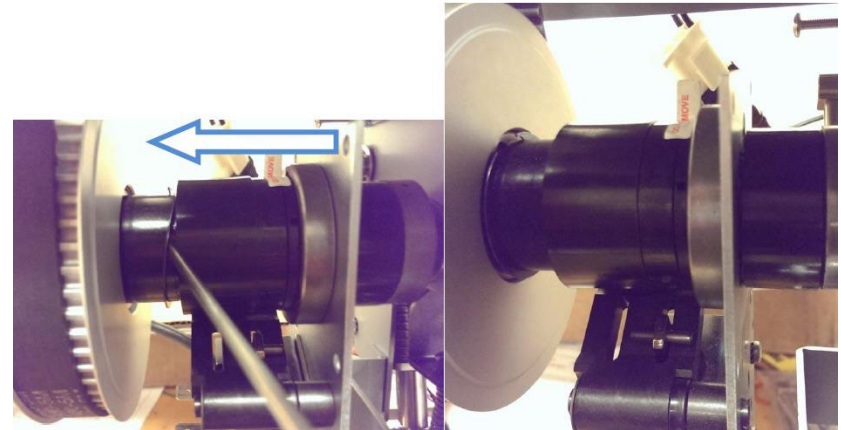

9. Move the control collar towards the pulley. By doing this the toothed hub will be exposed.

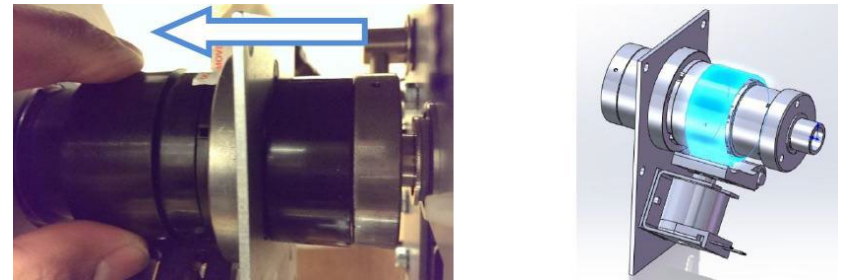

For some 230v machines, moving the stop collar towards the pulley may not expose the teeth completely. In such instances, remove the pulley off the clutch (3 sets of socket head screws and washers), see ARP 3.7 Clutch Pulley replacement.

10. Rotate the Stop collar.

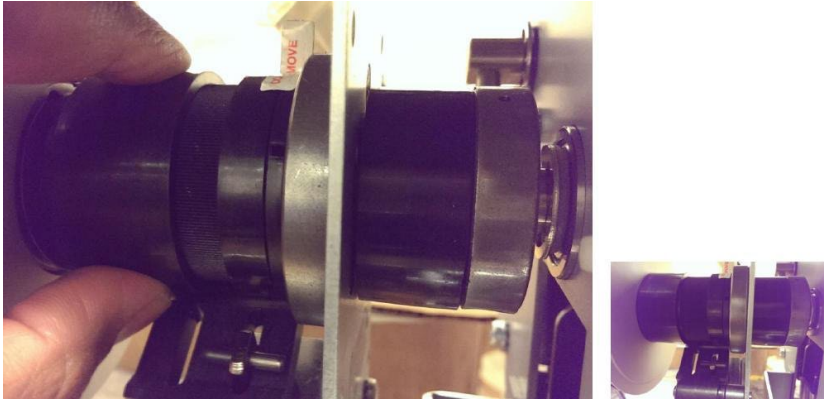

If the Punch Cam needs to stop earlier, rotate the Stop Collar Clockwise (when viewed from the rear of the machine).

If the Punch Cam needs to stop later, rotate the Stop Collar Counter-clockwise (when viewed from the rear side).

In this instance the cam needs to stop earlier, therefore rotate the Stop Collar Clockwise (when viewed from the rear side). This is done by manually lowering the pawl and freeing the Stop collar to rotate.

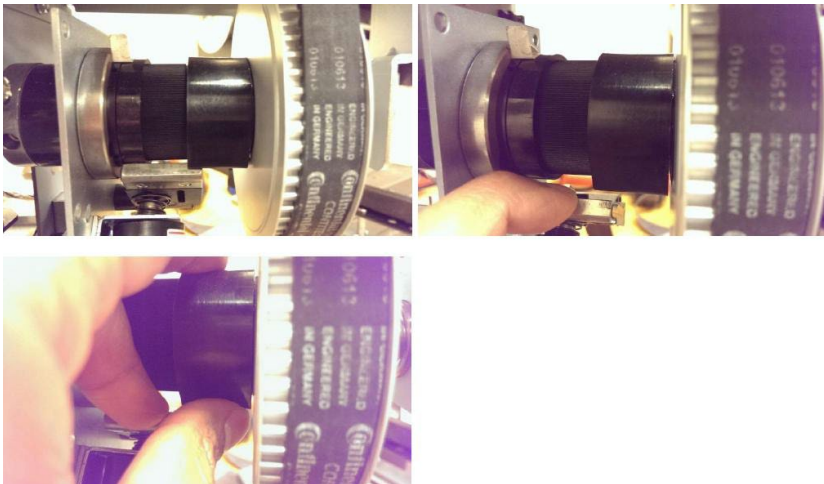

11. Slide the Stop collar back to its position and release the pawl.

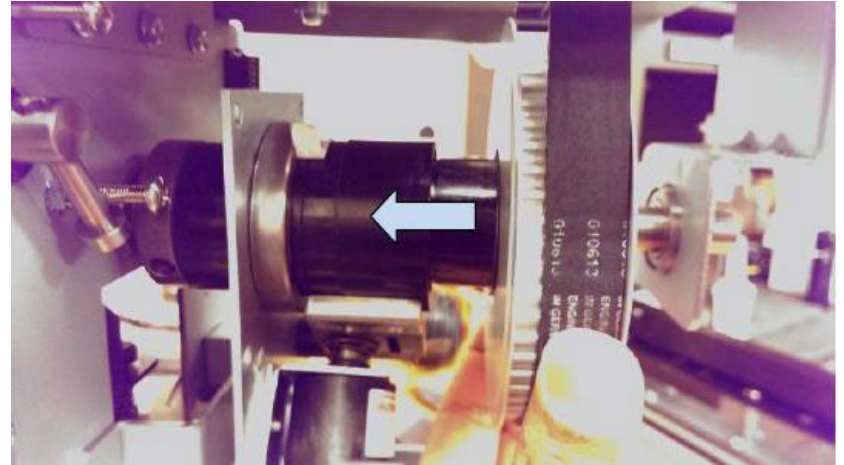

12. Manually rotate the pulley in the counter-clockwise direction by holding the pulley (viewed from rear side) to complete a punch cycle.

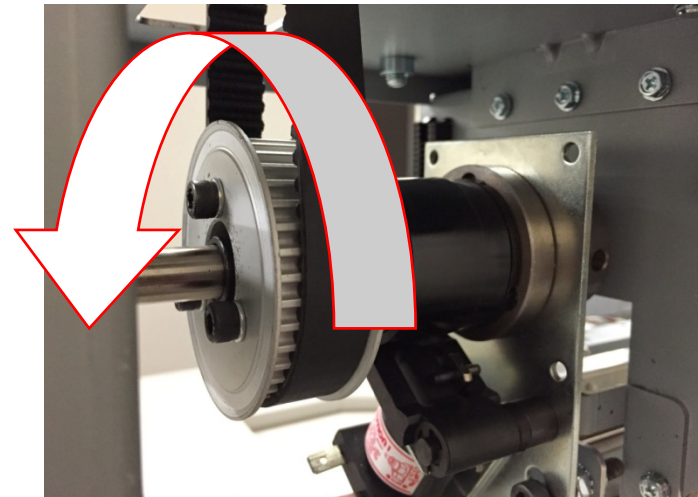
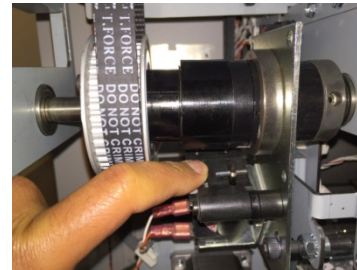

13. Repeat Steps 10 to 13 until the Punch shaft flats are horizontal. It is important to turn the punch shaft with a wrench until it hits a hard stop in the counter-clockwise direction (viewed from rear side). Important note: Turning the shaft with hand will not provide enough torque and the setting will be incorrect. Therefore use a wrench to turn the shaft.

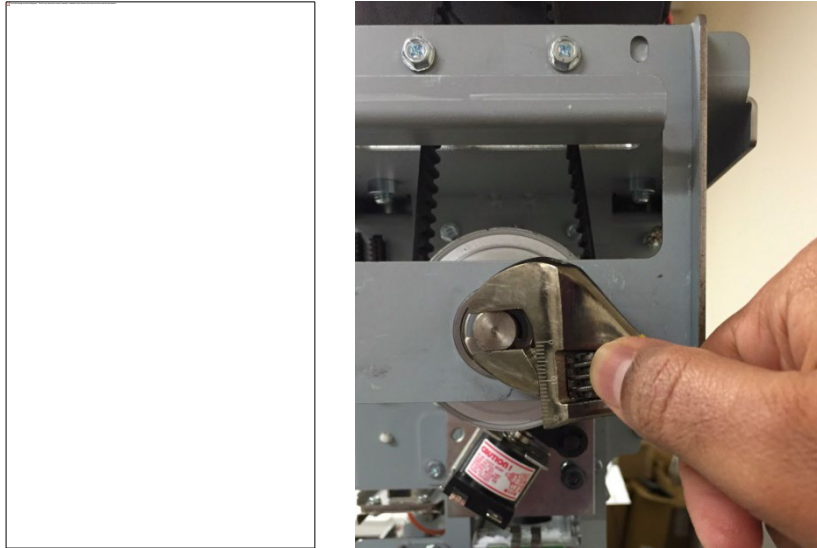

14. Return the spring clip to its groove.

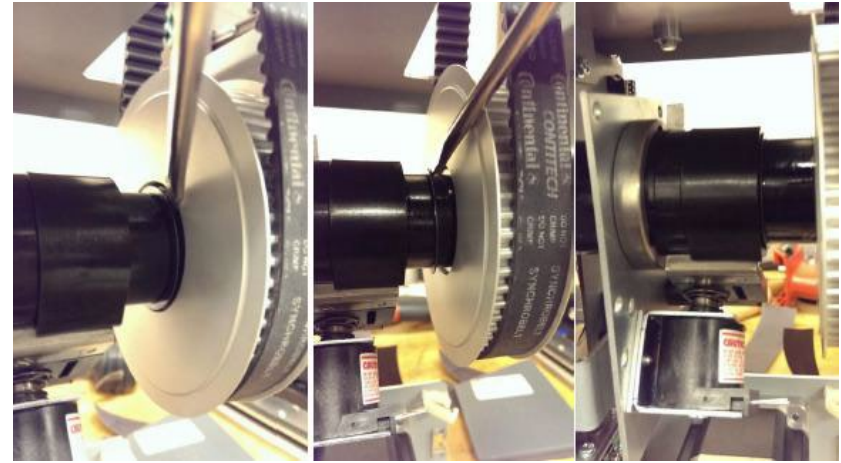

15. Do ARP 3.1 to remove the Punch Module.
16. Do ARP 1.6 to install the Rear Cover.
17. Connect the Power Cord.
18. Run one sheet of paper through the Punch.

Alternately "Cycle Punch" Function Test from Service mode can be performed.

After a punch cycle the flat in the front side would have returned to horizontal position (as shown in the pictures of Step# 1).

ADJ 1.6 Dieset Recognition Board Adjustment

PARTS LIST ON PL 4.9

Use this procedure to adjust the Dieset Recognition Board.

1. Do ARP 1.6 to remove the Rear Cover.
2. Loosen the Screws (2) that hold the Dieset Recognition Reader Board.



3. Insert a die set until the Dieset is about to contact the spring clips in the Reader Board.

4. Raise/ Lower the Reader Board so that the top most point of the Reader Board is above the surface of the Dieset Recognition Board in the Dieset.

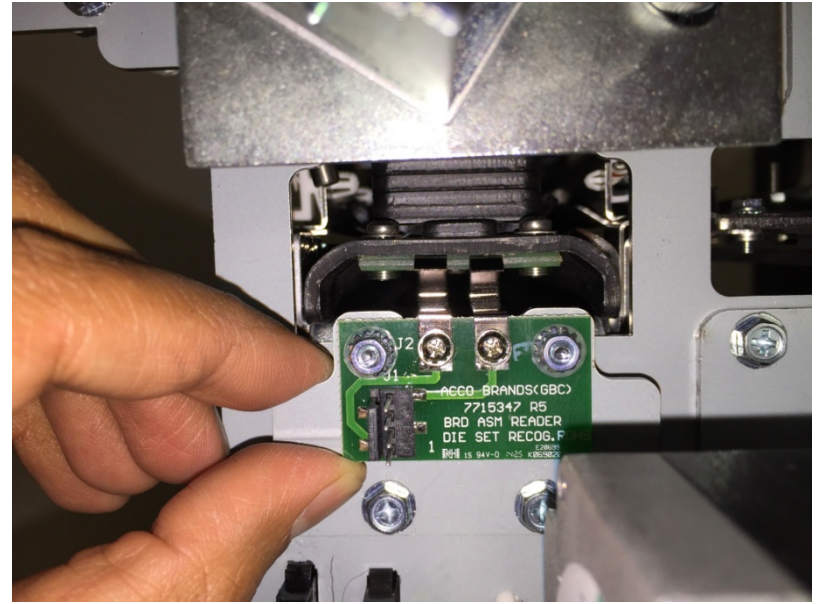

It can be set so that the top of the clips are just under the top surface of the recognition board. The spring clips will compress then the die set slides over. If the reader is set too low, the reader will not contact the recognition board. If the reader is set too high, there is a chance of mis-read and damage to clips.

5. Tighten the Screws (2) that hold the Dieset Recognition Reader Board.
6. Do ARP 1.6 to install the Rear Cover.

ADJ 1.7 Idler Panel Magnetic Latches Adjustment

PARTS LIST ON PL 3.2, PL 3.4, PL 3.5

Two round spacer studs should contact the drive panels completely (GP 6.16). When the Idler assembly is latched there should not be any movement in the assembly. If there is movement/play, do the below steps to adjust the assembly.

ADJ 1.4.6 Procedure

This procedure applies to

- Entrance Idler Panel (PL 3.2)
 - Exit Idler Panel (PL 3.4)
 - Upper Bypass Panel (PL 3.5)
1. Loosen the two screws that hold the magnet. With the panel closed firmly, pull away the magnet away from the drive panel (to eliminate the play in the magnet) and tighten both screws. The screws should be tightened while the panel is closed firmly and the magnet pulled away as shown.

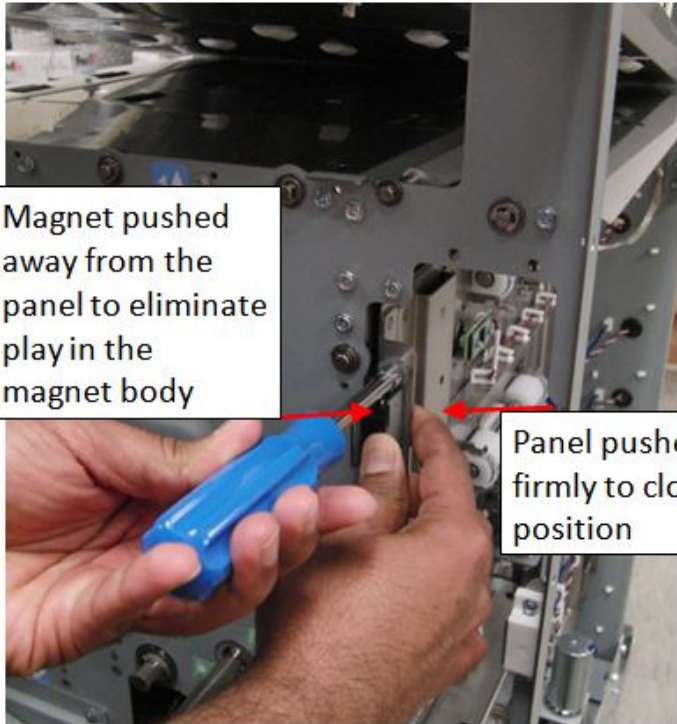

ADJ 1.4.7 Procedure

This procedure applies to

- Lower Exit Panel Assembly (PL 2.1)
1. Loosen the two screws that hold the magnet. With the panel fully closed (the panel will hit limiting tabs and you will hear a sound), tighten the two screws.

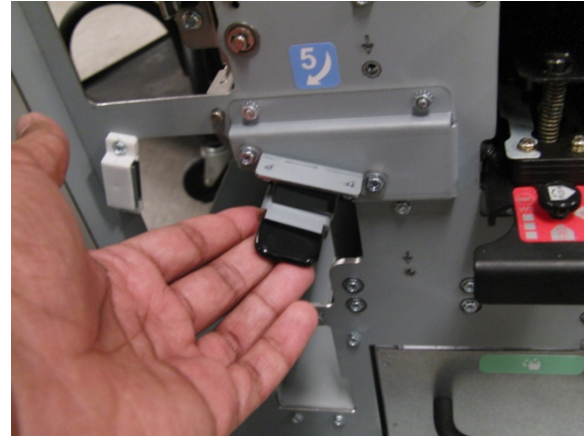

ADJ 1.8 Drive Panel Position Adjustment

PARTS LIST ON PL 2.2, PL 2.3, PL 3.1

Use this procedure to Inspect and adjust the Drive panel positions. The drive panels control how far the drive rollers protrude into the paper path, which in turn control the roller nip forces. All drive rollers should be protruding $1.5\pm 0.5\text{mm}$ through the paper path.

This procedure applies to

This drive panel controls the nip forces of N2, N3, N4 and N5.

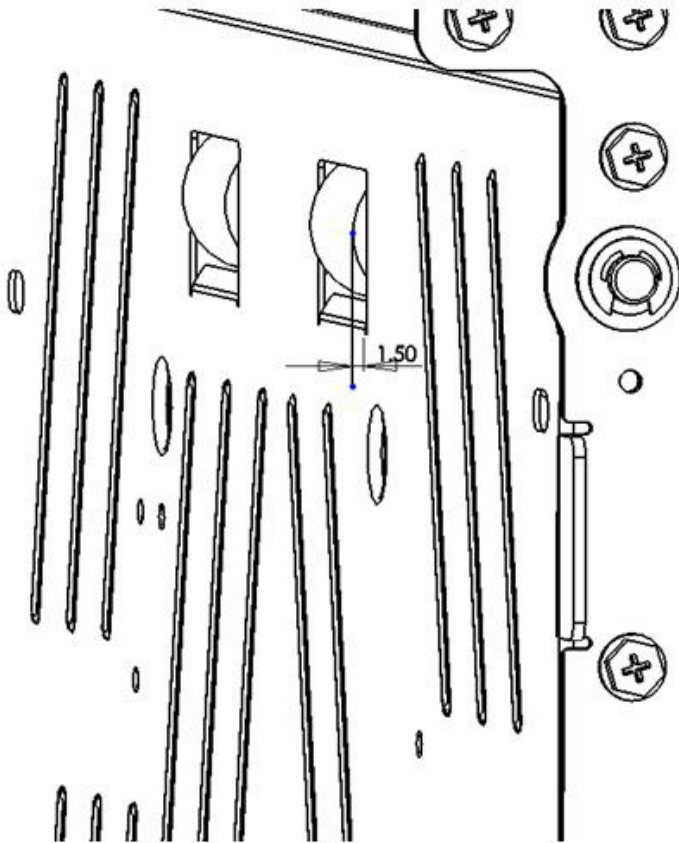

1. To adjust the position of the drive panel loosen (5) screws from the Front frame and (5) screws from the rear frame.

- Entrance Drive Panel (PL 3.1)
- Exit Drive Panel (PL 2.1)
- Lower Bypass Panel (PL 2.1)

ADJ 1.4.8 ADJ 1.8.1 Entrance Drive Panel Position Adjustment

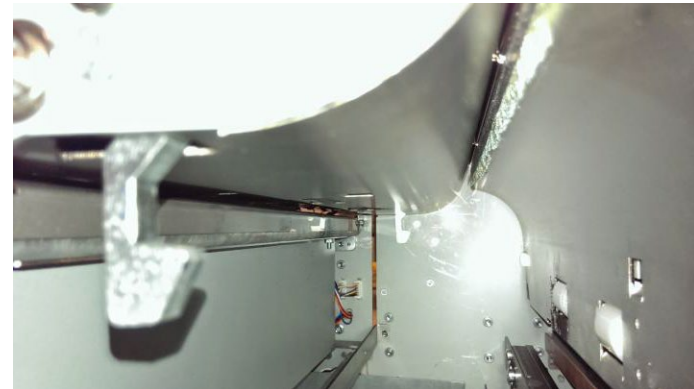
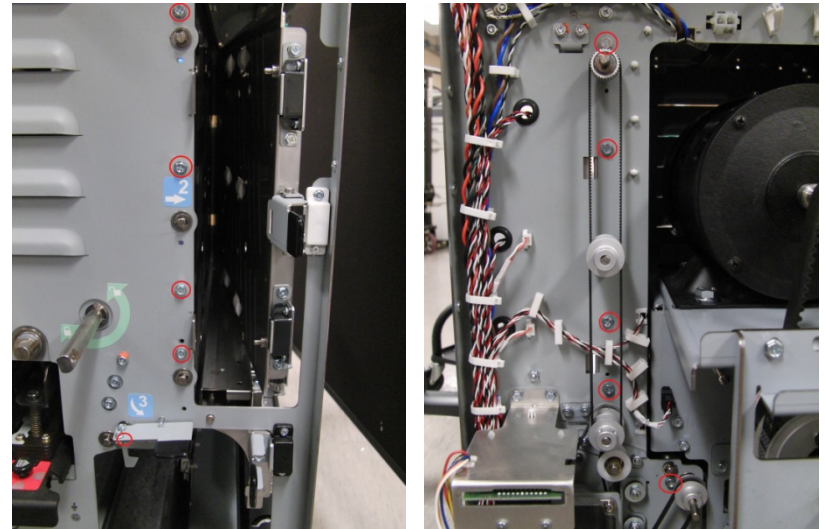

2. Using the Reference holes in the front/rear frame (5 holes in the front frame and 5 holes in the rear frame) and the sheet metal panel, position the drive panel to ensure the drive rollers protrude $1.5\pm 0.5\text{mm}$ through the drive panel.

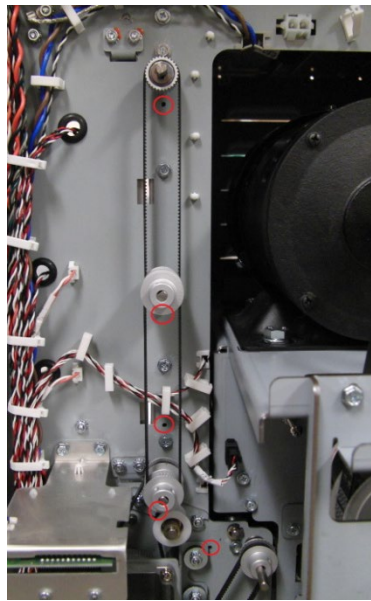

ADJ 1.4.9 ADJ 1.8.2 Exit Drive Panel Position Adjustment

This drive panel controls the nip forces of N8, N9 and N10.

1. To adjust the position of the drive panel loosen (5) screws from the Front frame and (5) screws from the rear frame (Cover plate of Jam area 5 needs to be removed).

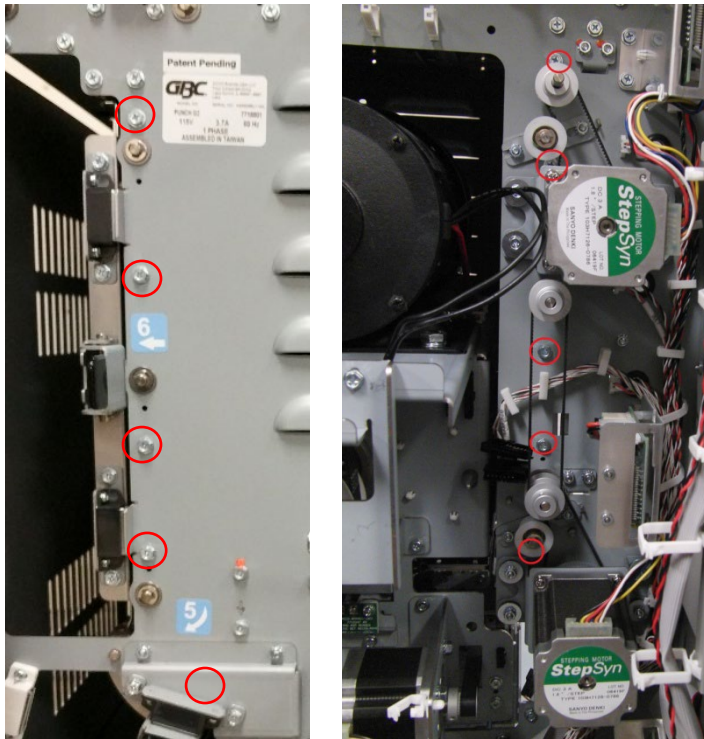

2. Using the Reference holes in the front/rear frame (4 holes in the front frame and 4 holes in the rear frame) and the sheet metal panel, position the drive panel to ensure the drive rollers protrude $1.5 \pm 0.5 \text{mm}$ through the drive panel.

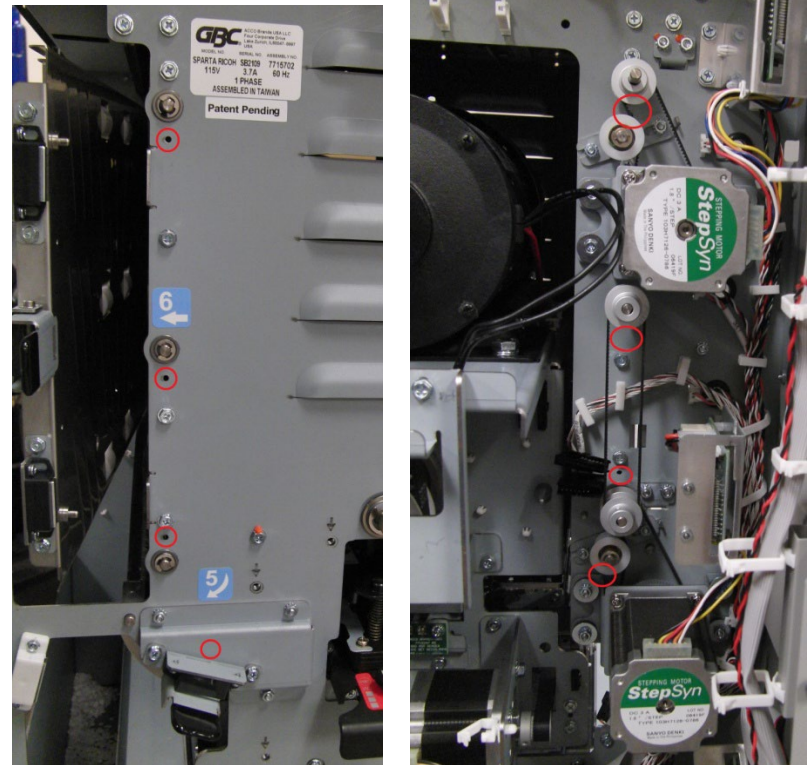

ADJ 1.4.11 ADJ 1.8.3 Lower Bypass Panel Position Adjustment

This drive panel controls the nip forces of N12, N13 and N14.

1. To adjust the position of the drive panel loosen (4) screws from the Front frame and (4) screws from the rear frame.

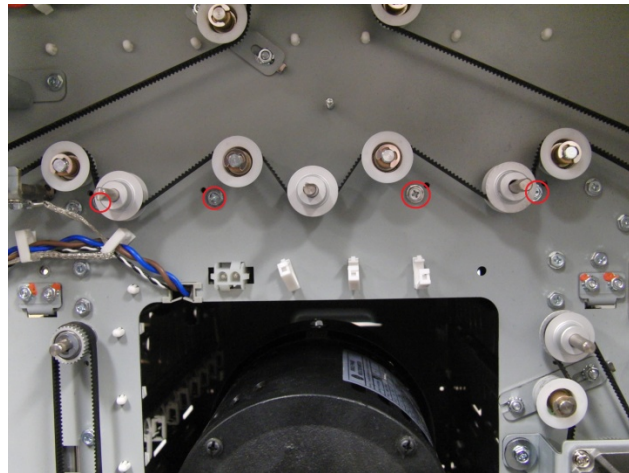
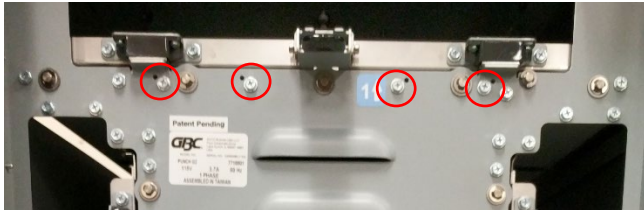

2. Using the Reference holes in the front/rear frame (4 holes in the front frame and 4 holes in the rear frame) and the sheet metal panel, position the drive panel to ensure the drive rollers protrude 1.5 ± 0.5 mm through the drive panel.

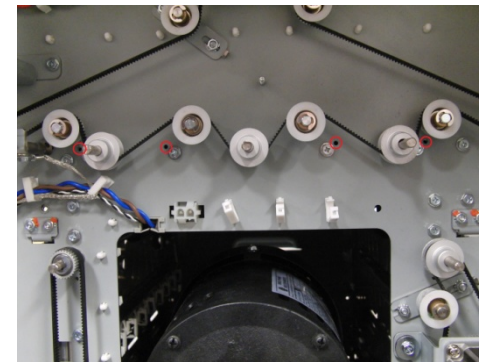

Notes:

5. Parts List (PL)

Section Contents

- 1. Main Assembly 2**
 - PL 1.1. Final Assembly 2
 - PL 1.2. Cabinet- Covers..... 3
- 2. Frame Assembly 4**
 - PL 2.1. Frame Assembly- Paper path panels 4
 - PL 2.2. Frame Assembly- Front side 5
 - PL 2.3. Frame Assembly- Rear Side 6
 - 6
 - PL 2.4. Frame Assembly- Drive Rollers..... 7
 - PL 2.5. Frame Assembly- Internal Parts 8
 - PL 2.6. Frame Assembly- Motors and Motor Drivers 9
 - PL 2.7. Frame Assembly- Sensors 10
 - PL 2.8. Frame Assembly- Solenoids / Switches 11
 - PL 2.9. Frame Assembly- Belts 12
- 3. Paper Path 13**
 - PL 3.1. Paper Path- Entrance Drive Panel .. 13
 - PL 3.2. Paper Path- Entrance Idler Panel.... 14
 - PL 3.3. Paper Path- Acceleration Roller Idler15
 - PL 3.4. Paper Path- Exit Idler Panel 16
 - PL 3.5. Paper Path- Upper Bypass Panel ... 17
 - PL 3.6. Paper Path- Disengaging Roller Solenoid 18
- 4. Punch Module 19**
 - PL 4.1. Punch Module..... 19
 - 19
 - PL 4.2. Punch Module (continued)..... 20
 - PL 4.3. Punch Module- Motors/Sensors 21
 - PL 4.4. Punch Module- Steering Module 22
 - PL 4.5. Punch Module- Steering Module - Steering Idler Panel Sub
Assembly 23
 - PL 4.6. Punch Module- Steering Module - Drive Panel Steering 24
 - PL 4.7. Punch Module- Stepper Alignment Bracket 25
 - PL 4.8. Punch Module- Punch Clutch..... 26
 - PL 4.9. Punch Module- Die Set Recognition Reader Board 27
 - PL 4.10. Punch Module- Die Rail, Backgage, Align Sensors, Sub
Assembly 28
 - PL 4.11. Punch Module- AC Motor 29
- 5. Die Sets 30**
- 6. Electronics 31**
 - PL 6.1. Electronics PCB Assembly 31

- PL 6.2. Control Board Bracket Sub Assembly32
- PL 6.3. Cable Part Number Index 33
- PL 6.4. Wiring Drawing..... 34
- 7. Installation Kit Parts 36**
- 8. Part Number Index 37**

Main Assembly

PL 1.1. Final Assembly

ITEM	Part #	DESCRIPTION	QTY
1	7723401	StreamPunch VFX 115V	1
	7723451	StreamPunch VFX 230V	1

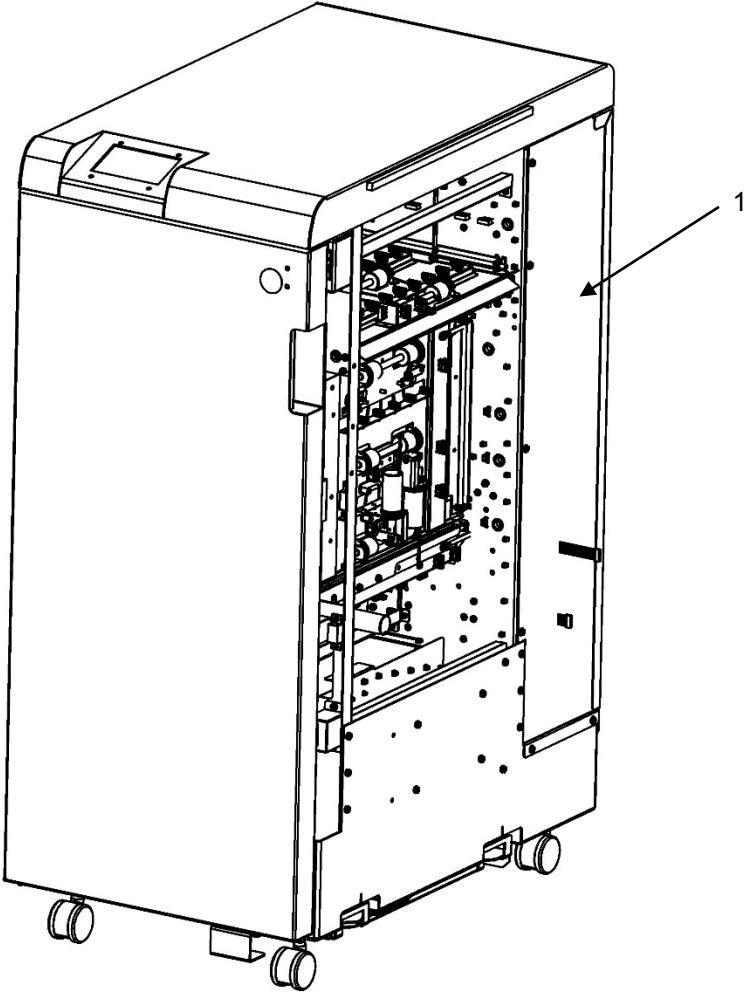

PL 1.2. Cabinet- Covers

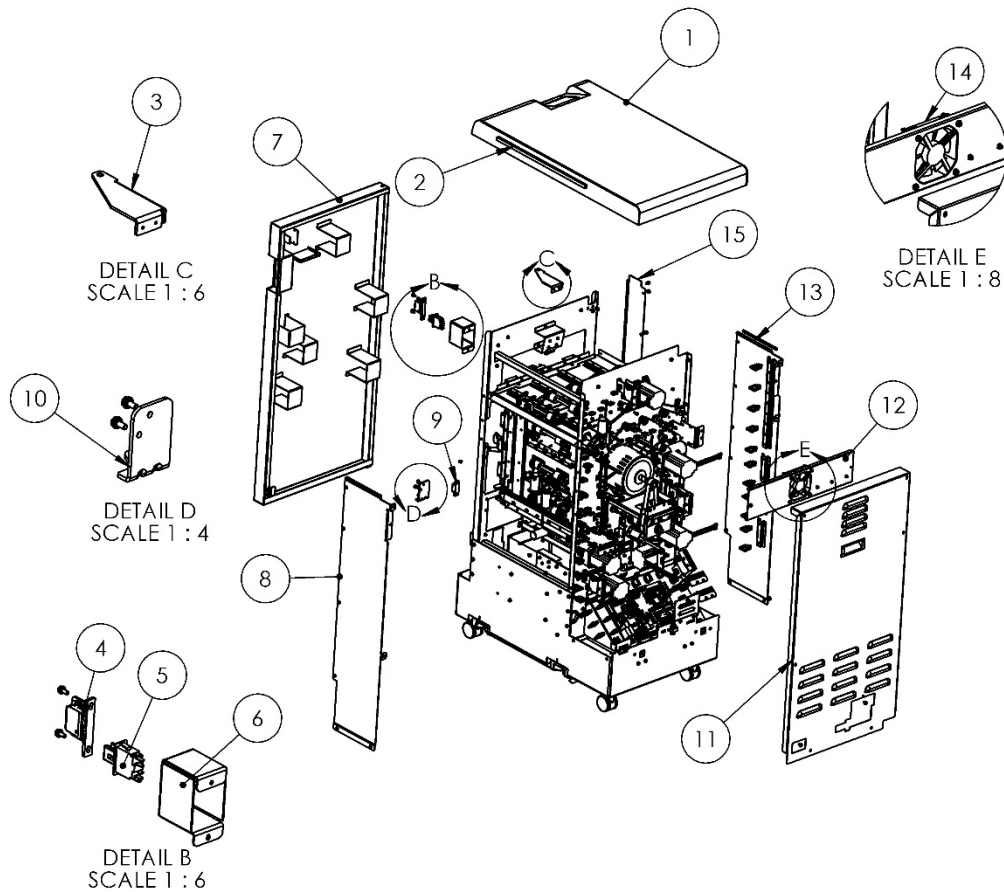

ITEM	GBC Part #	DESCRIPTION	QTY
1	7723423	COVER, TOP, ASSEMBLY	1
2	7715670	FOAM, TOP COVER	1
3	7715759	BRACKET, FRONT DOOR HINGE, TOP	1
4	7706486	LATCH, PUSH TO CLOSE, SOUTHCO	1
5	7610501	INTERLOCK SWITCH	1
6	7715793	BRACKET, INTERLOCK SWITCH, SPARTA	1
7	7723426	DOOR, FRONT, ASSEMBLY, SPARTA	1
8	7723419	COVER, SIDE, UPSTREAM	1
9	7715195	MAGNET, PANEL, OPEN, STRONG	1
10	7715761	BRACKET, DOOR HINGE, BOTTOM, FRAME	1
11	7723418	COVER, REAR, ASSEMBLY, SPARTA	1
12	7715575	EXHAUST FAN, BRACKET, ASSY, SPARTA	1
13	7723420	COVER, WELDMENT, SIDE, DOWNSTREAM	1
14	7715267	FAN, EXHAUST	1
15	7723442	COVER, SIDE, DOWNSTREAM, FRONT	2

Frame Assembly

PL 2.1. Frame Assembly- Paper path panels

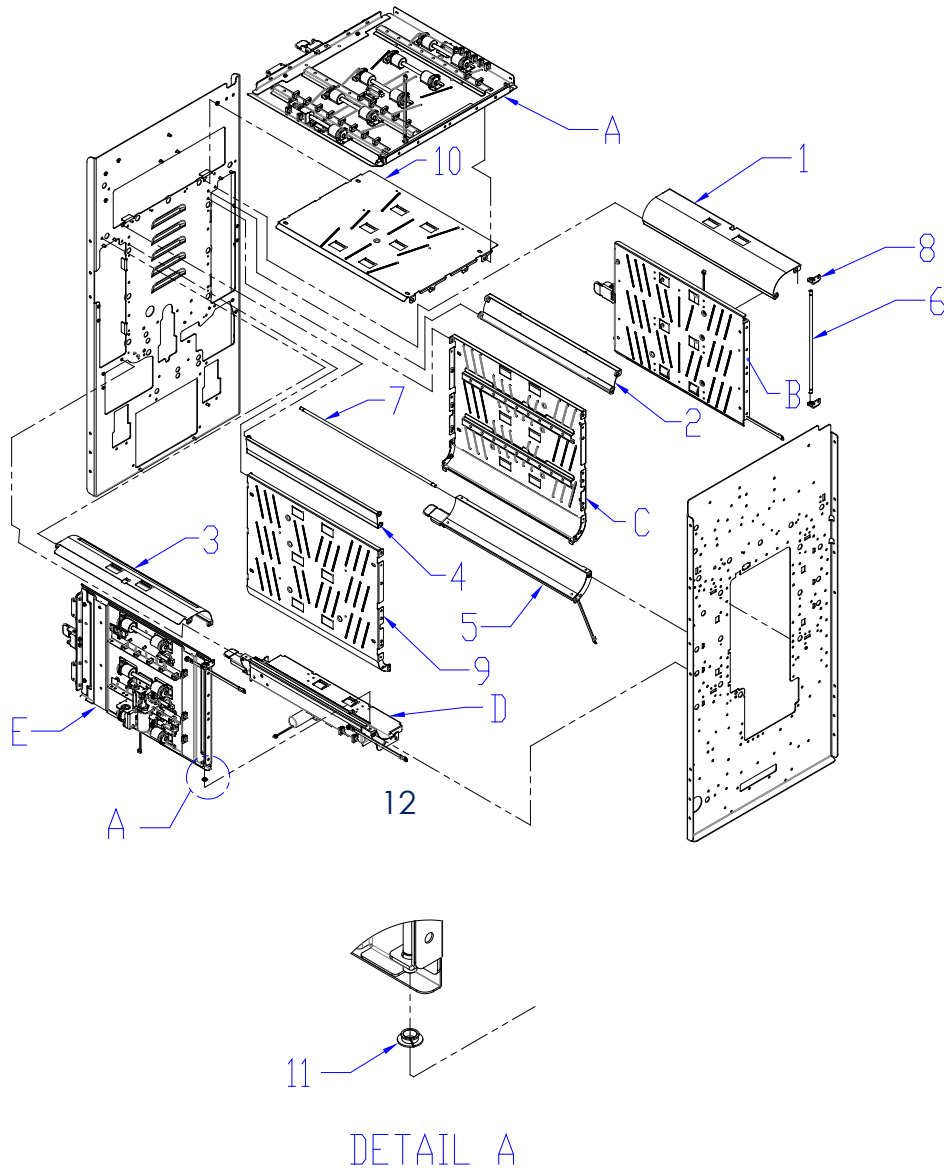

ITEM	GBC Part #	DESCRIPTION	QTY
A	PL 5.5	UPPER BYPASS PANEL	1
B	PL 5.2	ENTRANCE IDLER PANEL	1
C	PL 5.1	ENTRANCE DRIVE PANEL	1
D	PL 5.3	ACCELERATION IDLER PANEL	1
E	PL 5.4	EXIT IDLER PANEL	1
1	7715101	PANEL, ENTRANCE, LOWER	1
2	7715102	PANEL, ENTRANCE, INNER	1
3	7715146	PANEL, EXIT, LOWER	1
4	7715153	PANEL, EXIT, INNER	1
5	7724137	PANEL ASSEMBLY, LOWER, EXIT	1
6	7715209	SHAFT, IDLER PANEL HINGE	2
7	7715210	SHAFT, IDLER PANEL HINGE, LONG	2
8	7715251	BRACKET, IDLER PANEL MOUNT	6
9	7715150	PANEL WELDMENT, DRIVE, EXIT	1
10	7715128	PANEL WLDMNT, BYPASS, LOWER	1
11	1821209	SNAP-IN BEARING, 6MM ID [Qty. (2) used on all Idler panels- #A, #B, #D, #E and #5	10
12	7718619	SHAFT, IDLER PANEL, WITH GROOVE, EXIT SIDE	1

PL 2.2. Frame Assembly- Front side

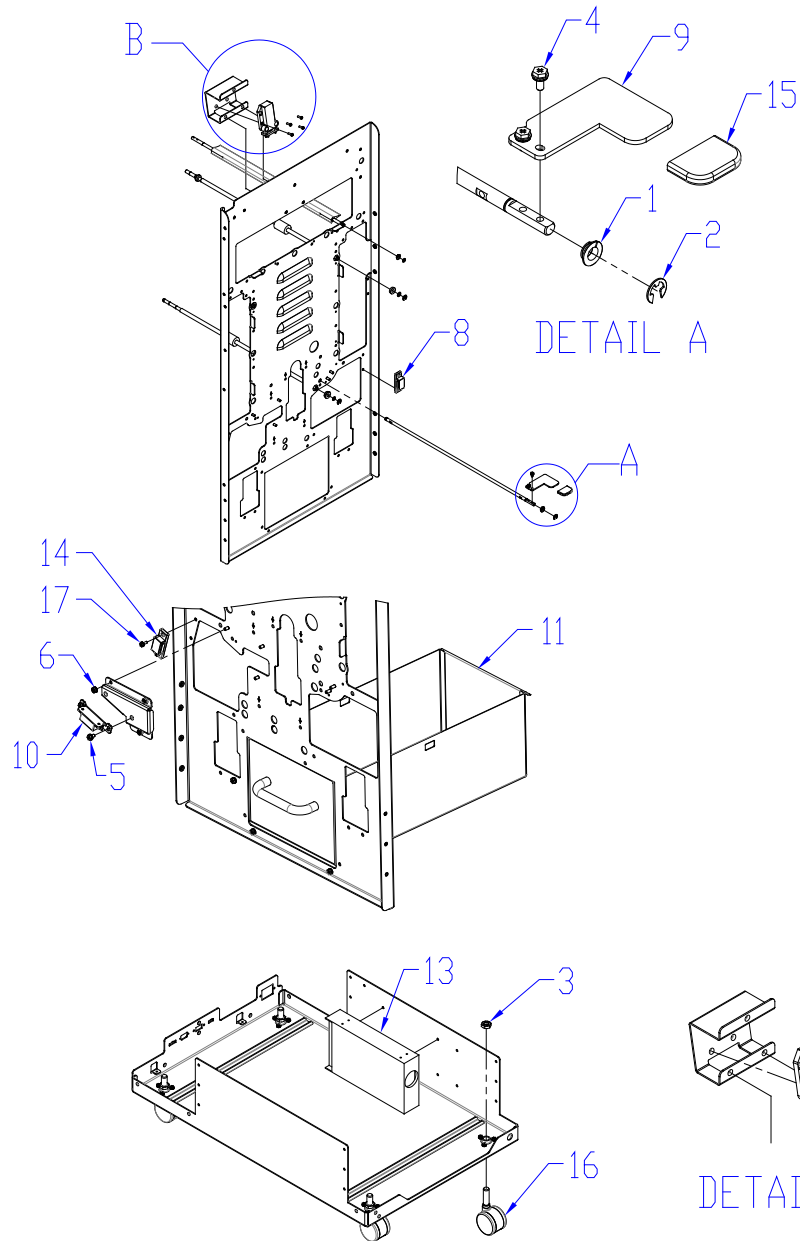

ITEM	GBC Part #	DESCRIPTION	QTY
1	1821209	Snap-in Bearing, 6mm ID	2
2	1822202	E-RING, JE-5	4
3	1823711	JAM NUT, M16X2.0	4
4	1823901	SCREW, HX, W/SEMS,M3X6	2
5	1823909	SCREW, HX, W/SEMS M4X6	2
6	1824001	NUT, KEPS M4	3
7	1821606	SCREW, PHILLIPS PAN HD, M3X10	6
8	7715195	MAGNET, PANEL, OPEN, STRONG	1
9	7715215	HANDLE, ACCEL IDLER LATCH	1
10	7715385	MAGNET, BRACKET, ASSY	1
11	7715427	CHIP TRAY, ASSEMBLY	1
12	7715650	LATCH, BYPASS	1
13	7715637	POWER SUPPLY, 24V, MW SP 480,	1
14	7715789	MAGNET, PANEL, OPEN, WEAK	3
15	7708163	CAP, RUBBER, RAIN BLUE	2
16	7715630	CASTER, ADJUSTABLE	4
17	1823913	SCREW, HX, W/SEMS, M3 X 8	8

PL 2.3. Frame Assembly- Rear Side

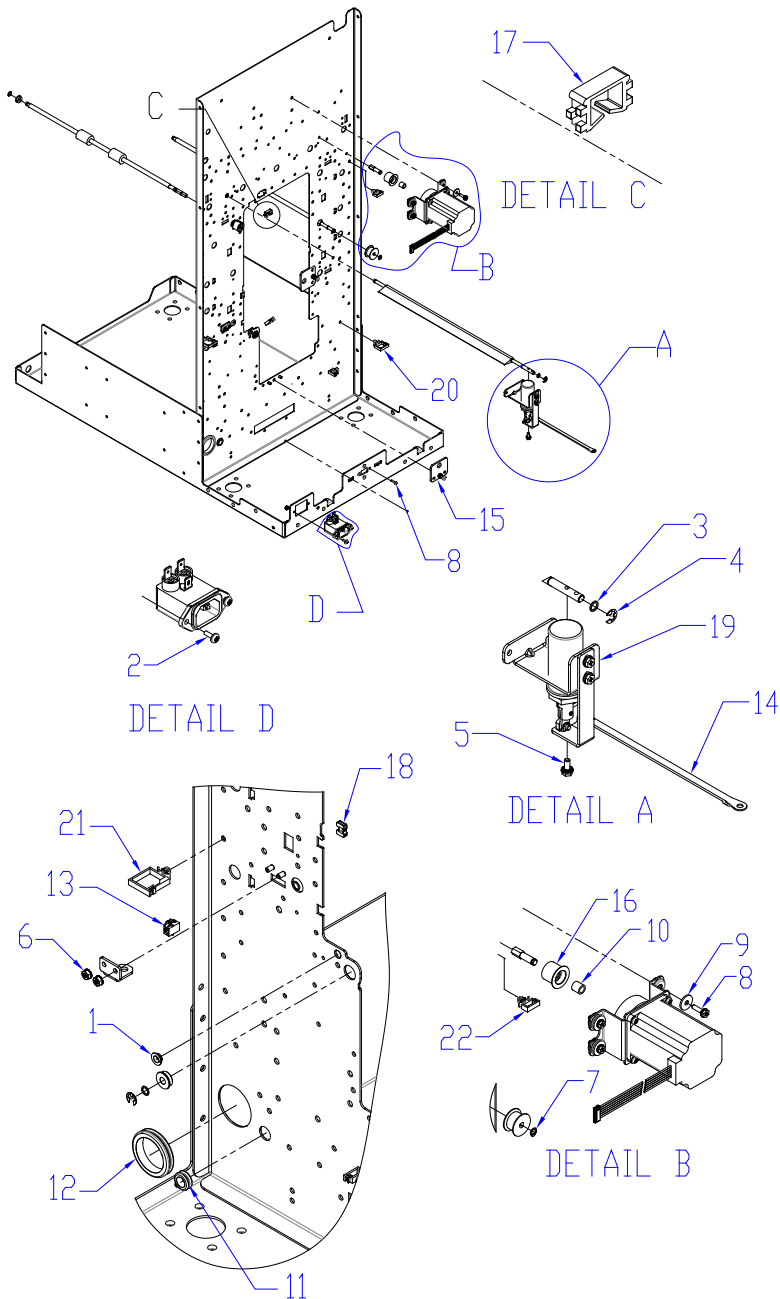

ITEM	GBC Part #	DESCRIPTION	QTY
1	1821209	Snap-in Bearing, 6mm ID	2
2	1821611	SCREW, PHILLIPS HD W/SEMS, M3X10	2
3	1822005	WASHER, FLAT, 6.025 X 8 X 0.75	2
4	1822202	E-RING, JE-5	7
5	1823910	SCREW, PHILLIPS HX HD W/SEMS M4 X 14	12
6	1824001	NUT, KEPS M4	32
7	1825501	RETAINING RING, 6MM SHAFT	15
8	1902863	SCREW, MACHINE PAN #4-40x15/32 PHILLIPS	2
9	1925044	WSHR, .192 ID X .625 OD X .060 T	20
10	1952208	SPACER, TIMING BELT IDLERS, BRONZE	4
11	1954011	GROMMET, 3/8 I.D X 1/2 O.D	11
12	1954032	GROMMET, 1 1/4 I.D. X 1 1/2 O.D.	1
13	7712703	WIRE HEADER CONNECTOR, 2 POS	6
14	7714679	GROUND STRAP, M4	1
15	7715185	BRACKET, PUNCH MODULE MOUNT	2
16	7715383	ROLLER, IDLER, DRIVE ASSY,	4
17	7715390	WIRE CLAMP, EDGE	1
18	7715445	WIRE CLAMP, EDGE, SMALL	2
19	7715813	SOLENOID, BRACKET, DIVERTER, SUB ASSY	1
20	7715818	WIRE SADDLE, MEDIUM, LOCKING TOP, V-0	10
21	7715819	WIRE SADDLE, LARGE, LOCKING TOP, V-0	8
22	7715817	WIRE SADDLE, SMALL, LOCKING TOP, V-0	32

PL 2.4. Frame Assembly- Drive Rollers

ITEM	GBC Part #	DESCRIPTION	QTY
1	7715093	ROLLER ASSY, DRIVE	11
2	7715097	ROLLER ASSY, ONE WAY CLUTCH DRIVE	1
3	1821116	BEARING, BALL, FLANGE 6X13X5, SUJ2	22
4	1822005	WASHER, FLAT, 6.025 X 8 X 0.75	22
5	1822202	E-RING, JE-5	26
6	7706532	BEARING BALL FLANGE	2
7	1925222	WASHER FLAT, 1/4X3/8X1/32	2
8	7715862	ONE WAY CLUTCH SUB ASSEMBLY	1

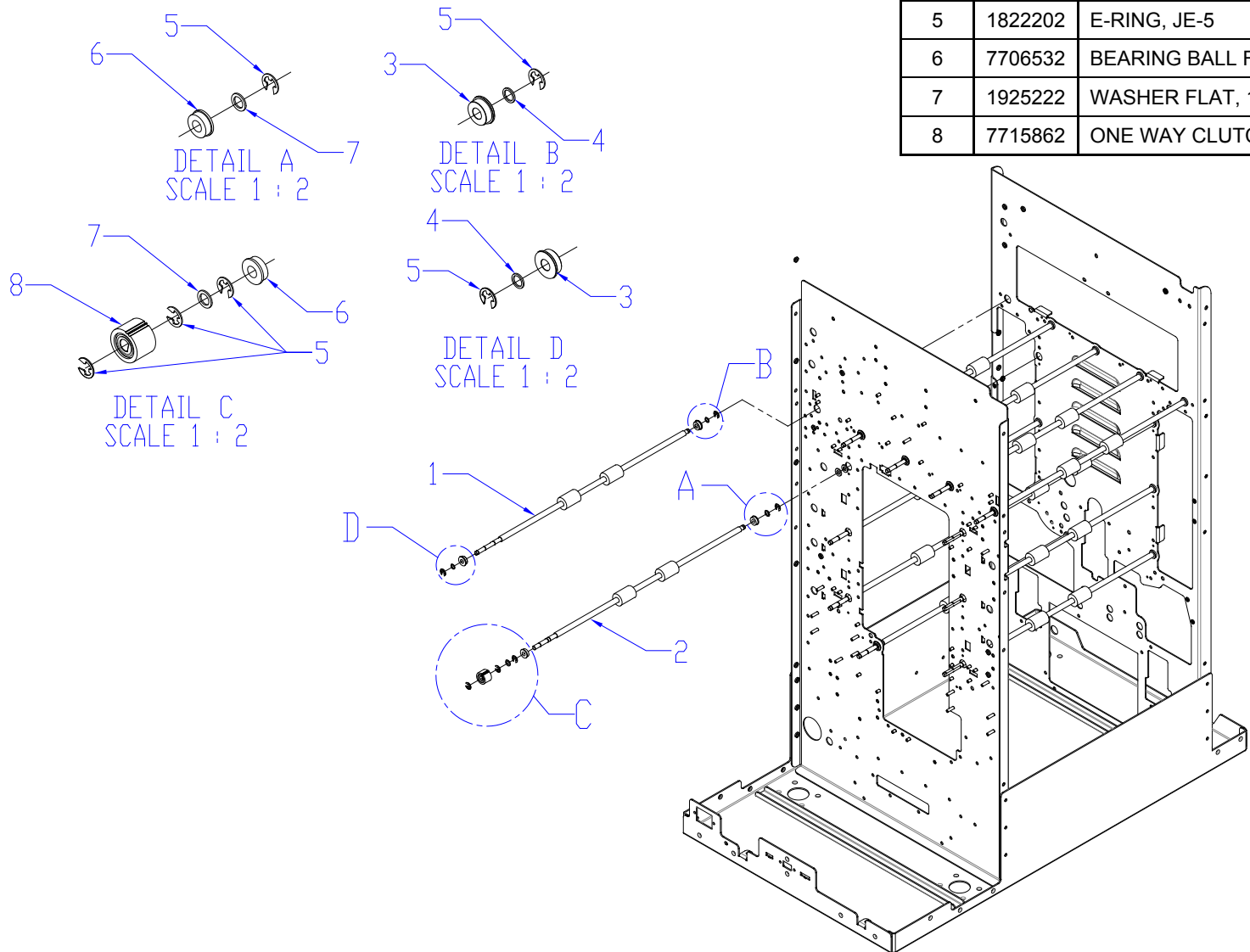

PL 2.5. Frame Assembly- Internal Parts

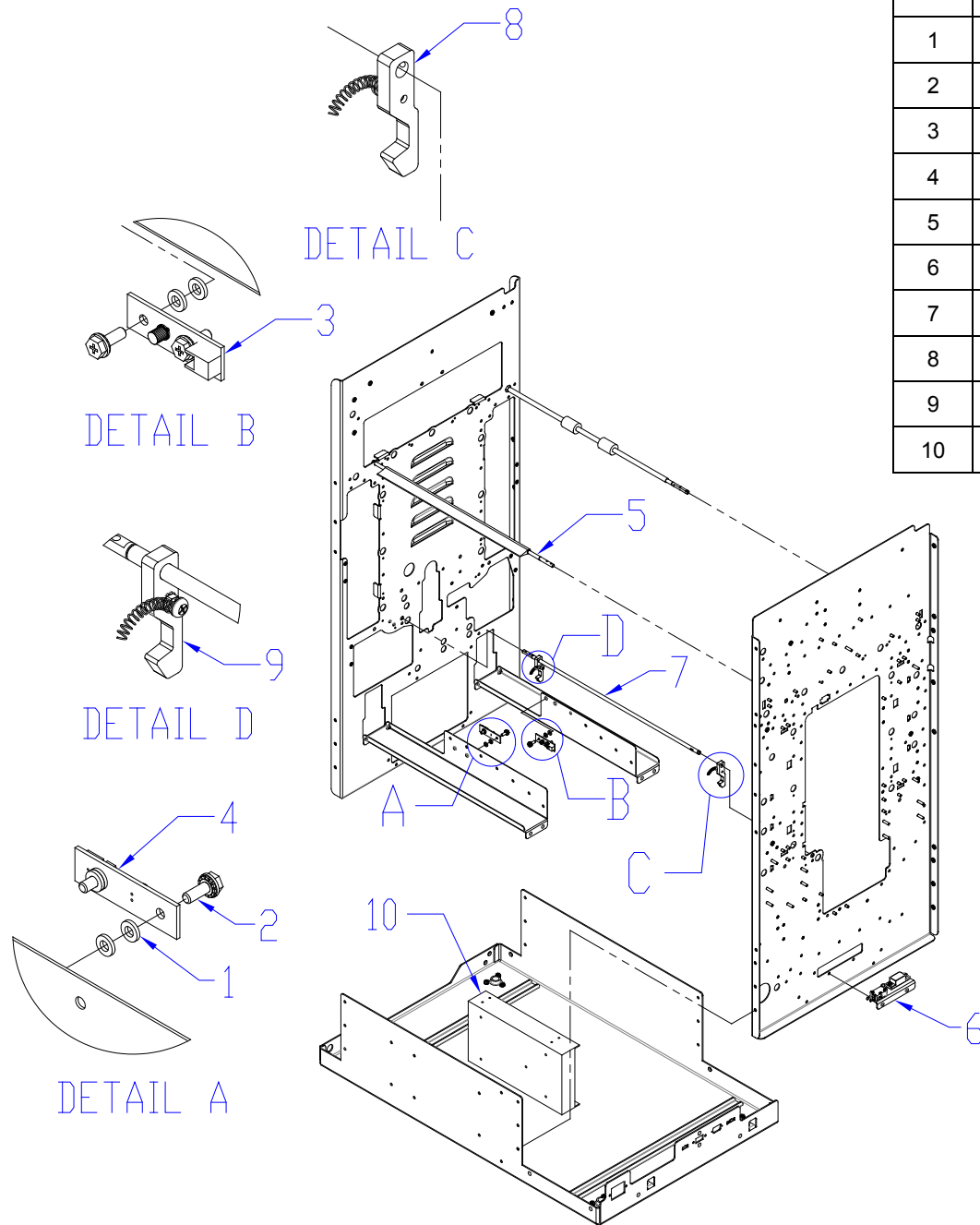

ITEM	GBC Part #	DESCRIPTION	QTY
1	1822108	WASHER, FLAT, 4.1X8X1.5	8
2	1823911	SCREW, PHILLIPS HX HD W/SEMS M4 X 10	4
3	7711970	EMITTER	1
4	7711973	RECEIVER	1
5	7715131	BYPASS DIVERTER	1
6	7715186	CHIP TRAY SENSOR MOUNT ASSY	1
7	7715213	SHAFT, ACCEL IDLER LATCH	1
8	7724141	LATCH, ASSY, REAR, ACCEL IDLER PANEL	1
9	7724140	LATCH, ASSY, FRONT, ACCEL IDLER PANEL	1
10	7715637	POWER SUPPLY, 24V, MW SP 480,	1

PL 2.6. Frame Assembly- Motors and Motor Drivers

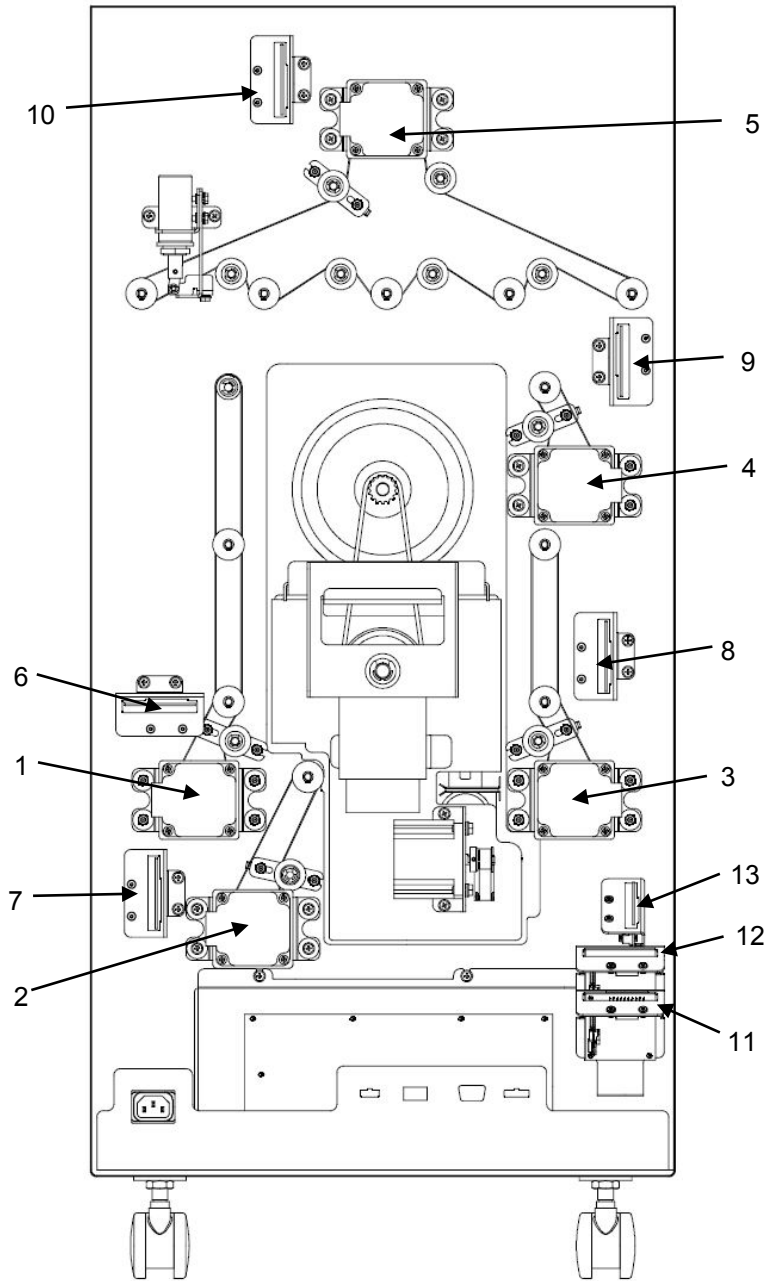

ITEM	GBC Part #		DESCRIPTION	QTY
1	7715159	M1	ENTRANCE MOTOR STEPPER AND MOUNT ASSY	1
2	7715159	M2	ACCEL MOTOR STEPPER AND MOUNT ASSY	1
3	7715159	M6	EXIT MOTOR STEPPER AND MOUNT ASSY	1
4	7715159	M7	DECEL MOTOR STEPPER AND MOUNT ASSY	1
5	7715159	M8	BYPASS MOTOR STEPPER AND MOUNT ASSY	1
6	7715275	DRV M1	M1 STEPPER DRIVER DRIVER AND BRACKET ASSY, TWO PHASE	1
7	7715275	DRV M2	M2 STEPPER DRIVER DRIVER AND BRACKET ASSY, TWO PHASE	1
8	7715275	DRV M6	M6 STEPPER DRIVER DRIVER AND BRACKET ASSY, TWO PHASE	1
9	7715275	DRV M7	M7 STEPPER DRIVER DRIVER AND BRACKET ASSY, TWO PHASE	1
10	7715275	DRV M8	M8 STEPPER DRIVER DRIVER AND BRACKET ASSY, TWO PHASE	1
11	7715275	DRV M3	M3 STEPPER DRIVER DRIVER AND BRACKET ASSY, TWO PHASE	1
12	7715275	DRV M4	M4 STEPPER DRIVER DRIVER AND BRACKET ASSY, TWO PHASE	1
13	7715275	DRV M5	M5 STEPPER DRIVER DRIVER AND BRACKET ASSY, TWO PHASE	1
SEE PL 6.3 FOR STEPPER MOTOR M3, M4 AND M5 POSITIONS				

PL 2.7. Frame Assembly- Sensors

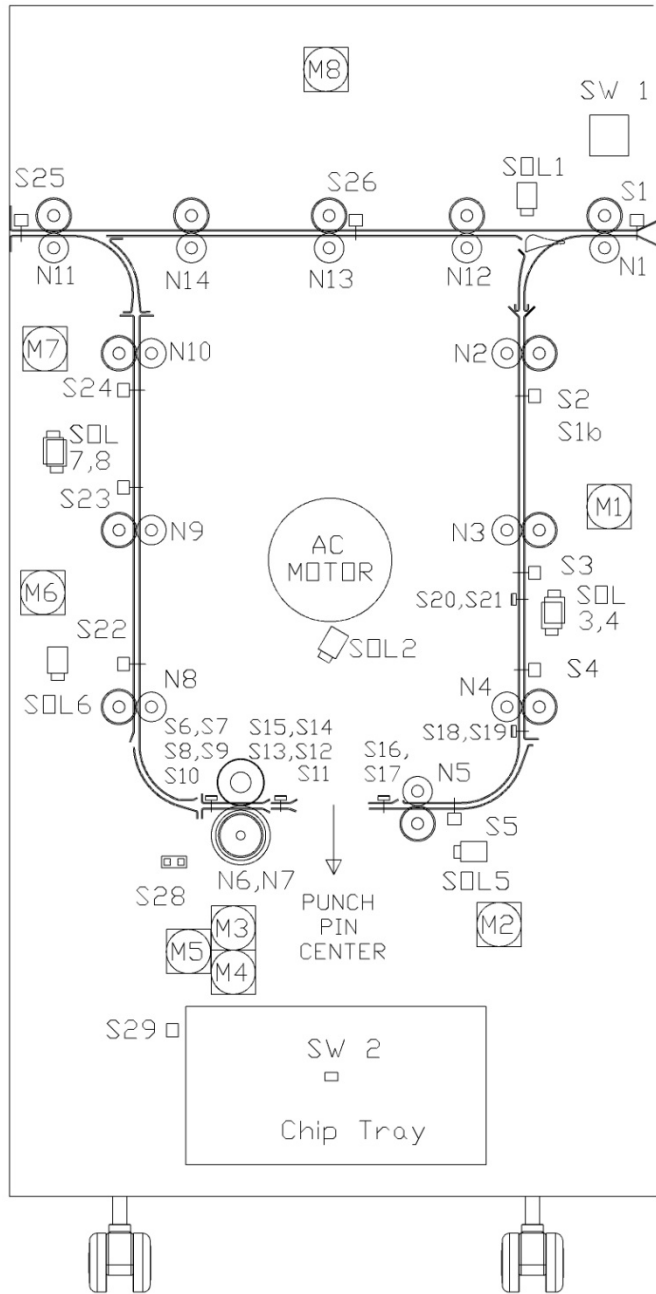

ITEM	GBC Part #		DESCRIPTION	QTY
1	7715627	S1	ENTRANCE SENSOR, S1	1
2	7715291	S2	ENTRANCE SENSOR, TOP	1
3	7715291	S3	ENTRANCE SENSOR, MIDDLE	1
4	7715291	S4	ENTRANCE SENSOR, BOTTOM	1
5	7715291	S5	ACCEL SENSOR	1
6	7715692	S6 S7 S8 S9 S10	SKEW SENSOR BOARD	1
7	7718567	S11 S12 S13 S14 S15	ALIGNMENT SENSOR BOARD, SWITCHABLE	1
8	7715696	S16 S17	BACKAGE SENSOR BOARD ASSY	1
9	7715696	S18 S19	MID PUNCH LARGE, SENSOR BACKAGE SENSOR BOARD ASSY	1
10	7715696	S20 S21	MID PUNCH X- LARGE, SENSOR BACKAGE SENSOR BOARD ASSY	1
11	7715291	S22	EXIT SENSOR, BOTTOM	1
12	7715291	S23	EXIT SENSOR, MIDDLE	1
13	7715291	S24	EXIT SENSOR, TOP	1
14	7715291	S25	EXIT SENSOR	1
15	7715291	S26	BYPASS SENSOR, MIDDLE	1
16	7715597	S28	ALIGN HOME SENSOR	1
17	7711970	S29	CHIP LEVEL SENSOR - EMITTER	1
	7711973	S29	CHIP LEVEL SENSOR - RECEIVER	1
18	7715774	S1B	CLEAR COVER SENSOR-EMITTER	1
	7711973	S1B	CLEAR COVER SENSOR-RECEIVER	1

PL 2.8. Frame Assembly- Solenoids / Switches

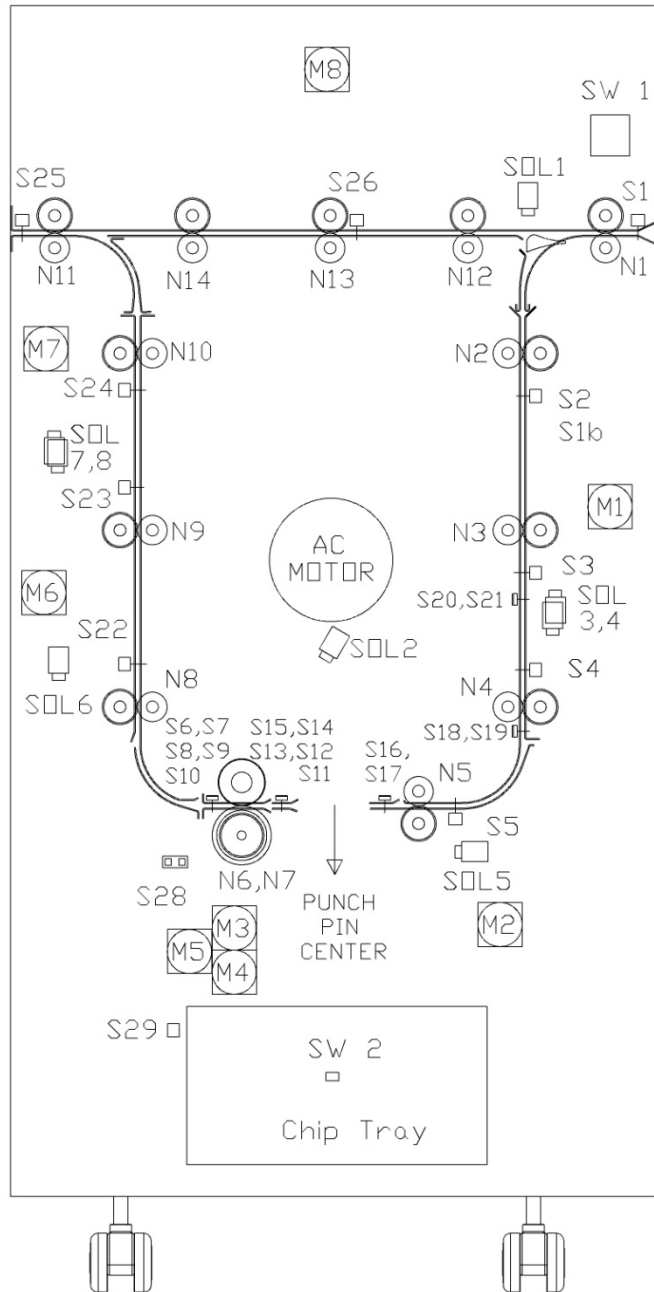

ITEM	GBC Part #		DESCRIPTION	QTY
1	7715813	SOL 1	DIVERTER SUBASSEMBLY	1
2	7715020	SOL 2	PUNCH CLUTCH	1
3	7724133	SOL 3	ENTRANCE IDLER SOLENOID, MIDDLE	1
4	7724133	SOL 4	ENTRANCE IDLER SOLENOID, BOTTOM	1
5	7724133	SOL 5	ACCELERATION ROLLER SOLENOID	1
6	7724133	SOL 6	EXIT IDLER SOLENOID, BOTTOM	1
7	7724133	SOL 7	EXIT IDLER SOLENOID, MIDDLE	1
8	7724133	SOL 8	EXIT IDLER SOLENOID, TOP	1
9	7610501	SW1	FRONT DOOR INTERLOCK SWITCH	1
10	7715186	SW2	CHIP TRAY HOME SWITCH ASSEMBLY	1

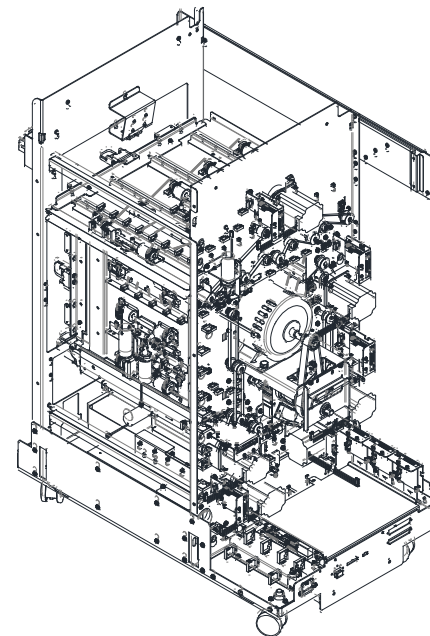

PL 2.9. Frame Assembly- Belts

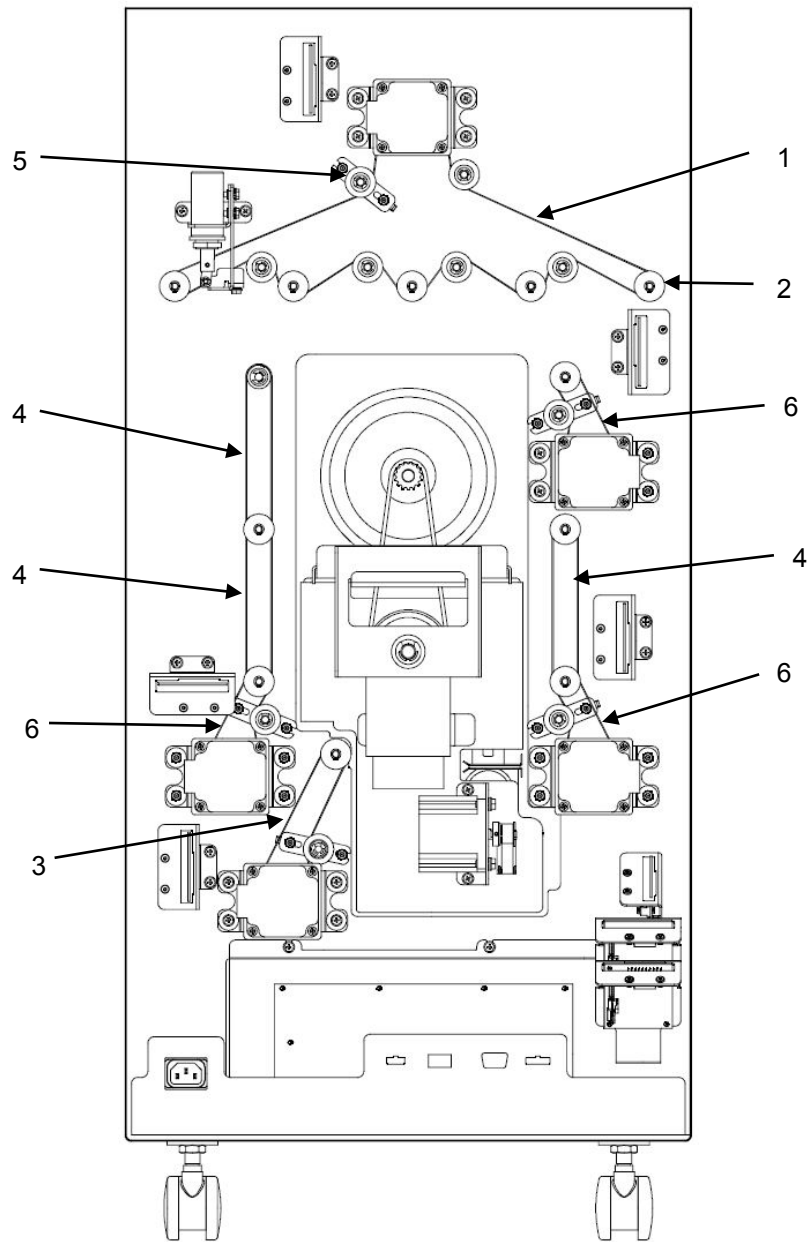

ITEM	GBC Part #	DESCRIPTION	QTY
1	7715202	BELT, 534T, 2MM 2GT	1
2	7715204	PULLEY,TIMING,2MM 2GT,30T	14
3	7715206	BELT, 179T, 2MM 2GT	1
4	7715243	BELT, 150 T, 2MM 2GT	3
5	7715245	TENSIONER ASSEMBLY	5
6	7715246	BELT, 134T, 2MM 2GT	3

Paper Path

PL 3.1. Paper Path- Entrance Drive Panel

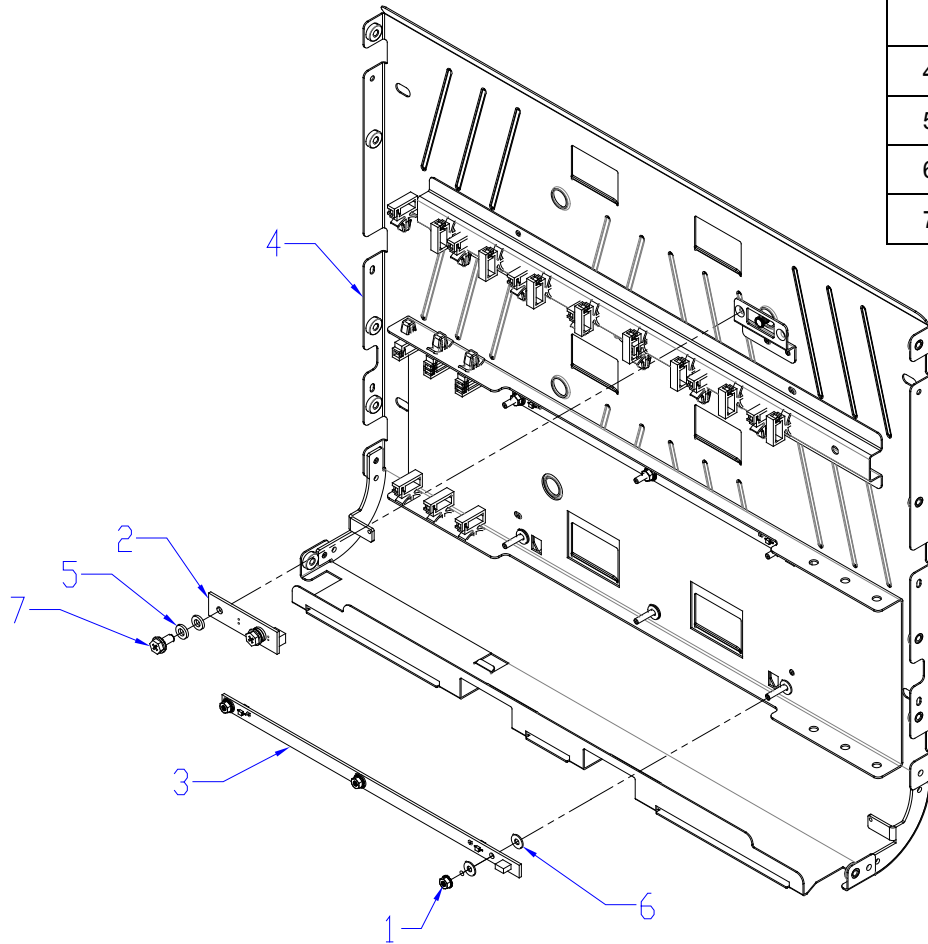

ITEM	GBC Part #		DESCRIPTION	QTY
1	1824002		NUT, KEPS, M3	6
2	7711973		RECEIVER	1
3	7715696	S18 S19	MID PUNCH, LARGE, SENSOR BOARD BOARD ASSY, BACKGAGE SENSOR	1
	7715696	S20 S21	MID PUNCH, X LARGE, SENSOR BOARD BOARD ASSY, BACKGAGE SENSOR	1
4	7715871		PANEL WLDMNT,DRIVE,ENTRANCE,SERVICE	1
5	1822108		WASHER, FLAT, 4.1X 8X1.5	4
6	1822117		WASHER, 3.2ID, 8OD, 0.75MM THICK	12
7	1823903		SCREW, PHILLIPS, HX HD M4X8	2

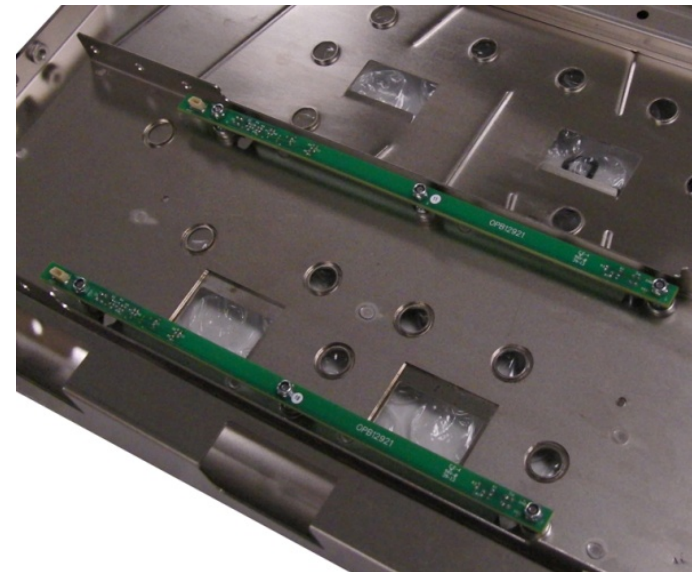

PL 3.2. Paper Path- Entrance Idler Panel

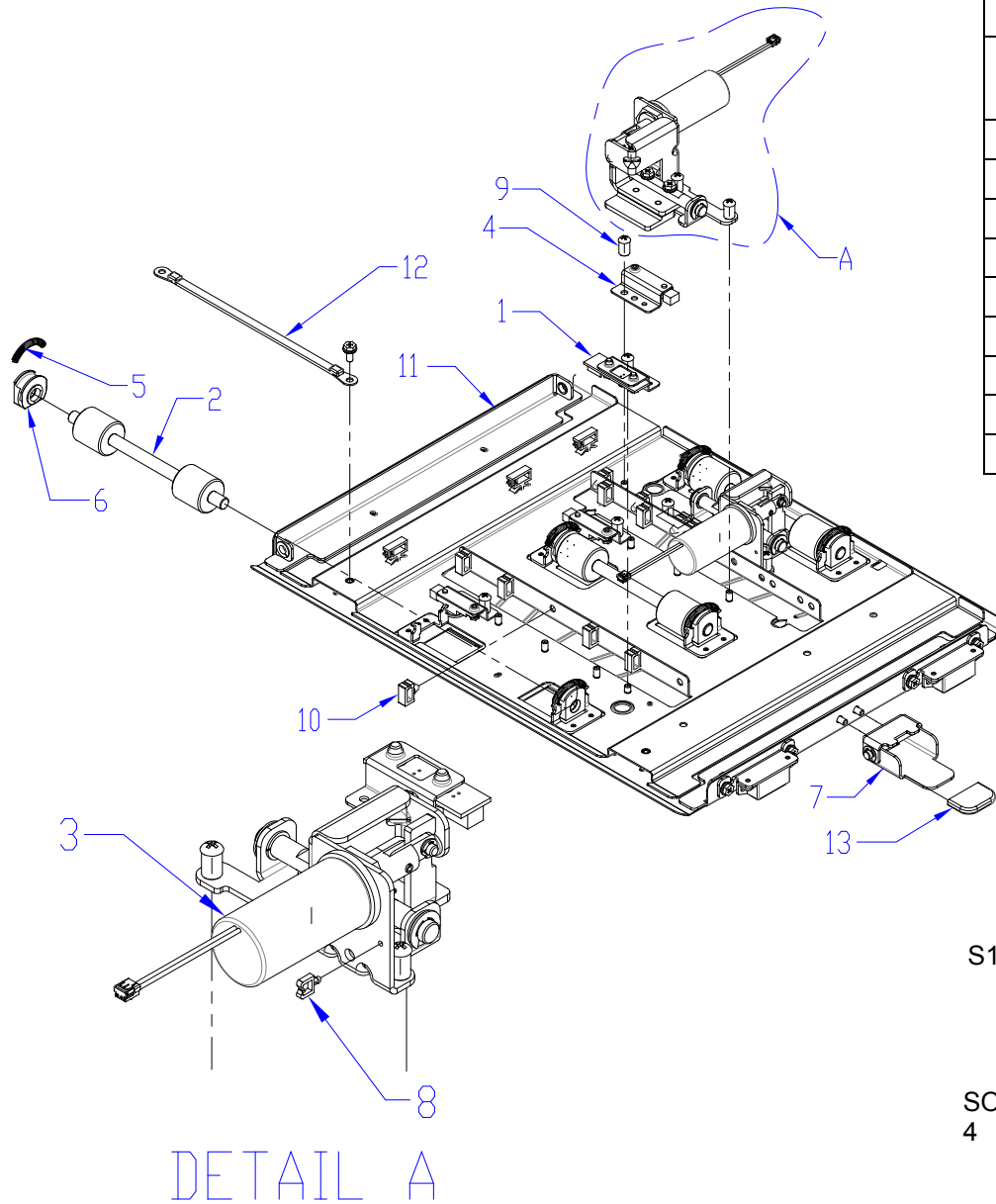

ITEM	GBC Part #		DESCRIPTION	QTY
1	7711970	S1b	EMITTER	1
2	7715103		ROLLER ASSY, IDLER	3
3	7724133	SOL3 SOL4	MODULE,SOLENOID,DISENGAGING ROLLER	2
4	7715291	S2 S3 S4	SENSOR AND BRACKET ASSY	3
5	7717410		SPRING,TRANSPORT IDLR ROLLER	6
6	7715382		BEARING HOUSING	6
7	7715384		HANDLE ASSY, IDLER PANELS	1
8	7715625		WIRE SADDLE, SHORT	2
9	7715629		SCREW, BARREL, M4, 7MM DEEP	13
10	7715639		WIRE SADDLE,SMALL,SIDE OPEN	11
11	7715873		PANEL WLDMT,IDLER,ENTRY	1
12	7714679		GROUND STRAP, M4	1
13	7708163		CAP, RUBBER	1

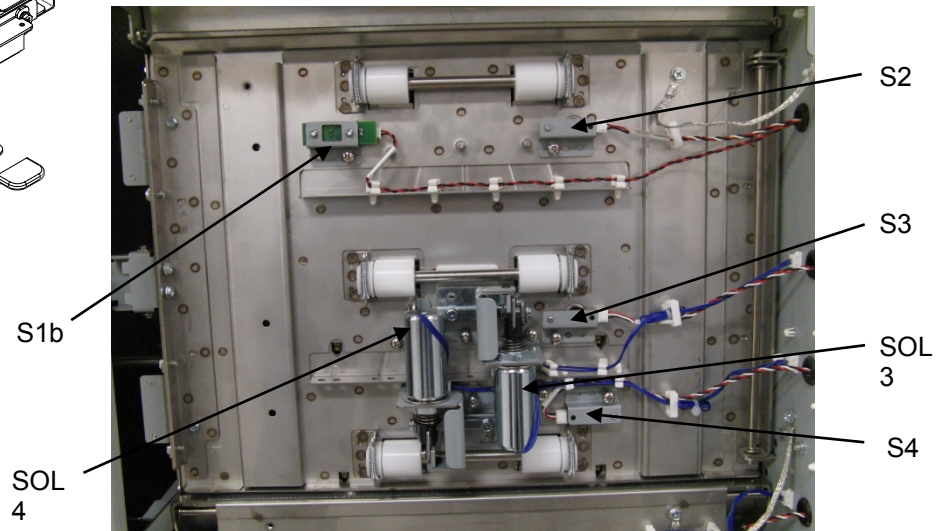

PL 3.3. Paper Path- Acceleration Roller Idler

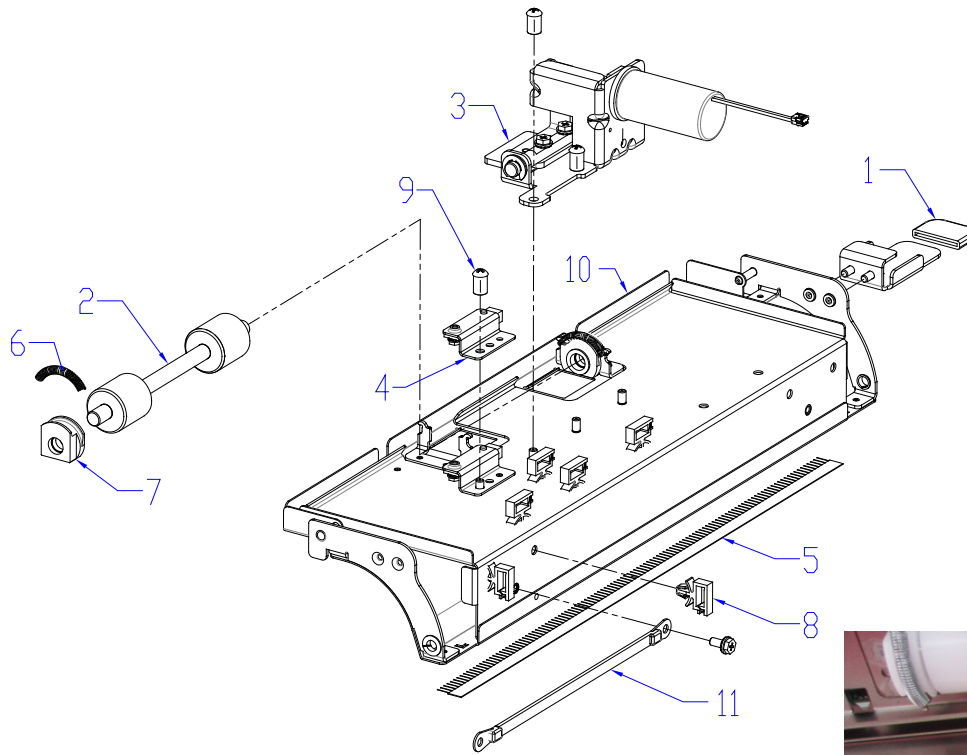

ITEM	GBC Part #		DESCRIPTION	QTY
1	7708163		CAP, RUBBER	1
2	7715103		ROLLER ASSY, IDLER	1
3	7724133	SOL 5	MODULE, SOLENOID, DISENGAGING ROLLER	1
4	7715291	S5	SENSOR AND BRACKET ASSY	1
5	7718626		BRUSH, ASSY, ANTI STATIC	1
6	7717410		SPRING, TRANSPORT IDLR ROLLER	2
7	7715382		BEARING HOUSING ASSY	2
8	7715817		WIRE SADDLE, SMALL	5
9	7715629		SCREW, BARREL, M4, 7MM DEEP	4
10	7718628		PANEL WLDMNT, IDLER, ACCEL	1
11	7714679		GROUND STRAP, M4	1

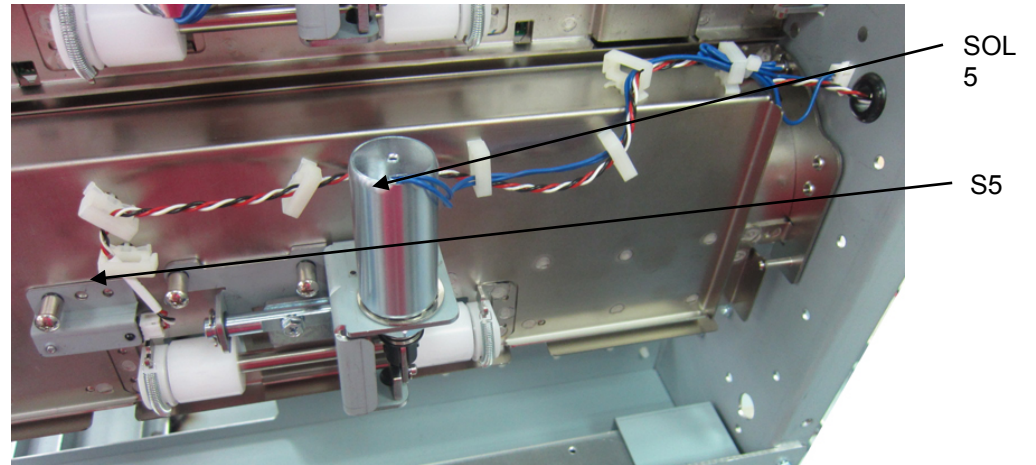

PL 3.4. Paper Path- Exit Idler Panel

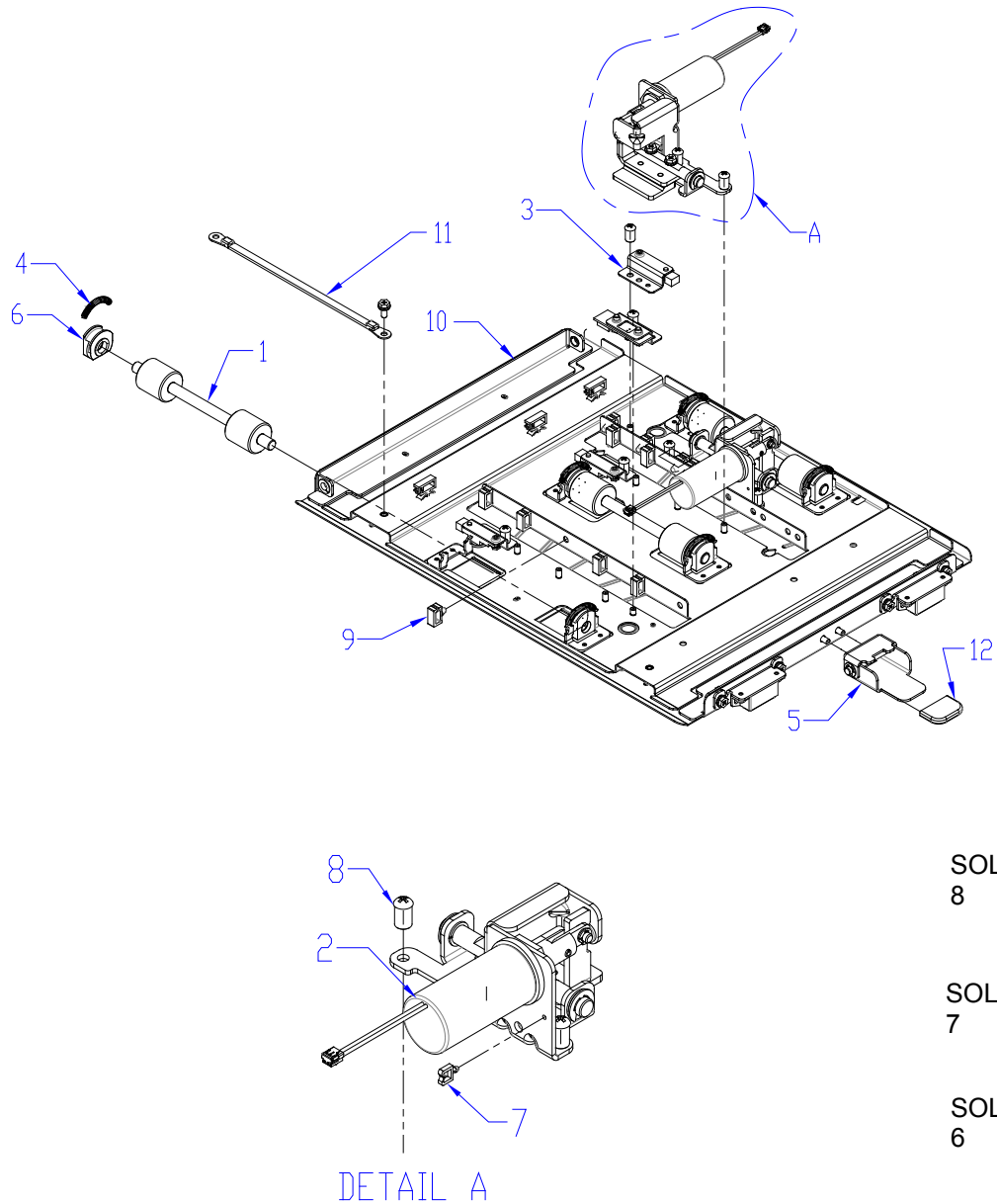

ITEM	GBC Part #		DESCRIPTION	QTY
1	7715103		ROLLER ASSY, IDLER	3
2	7724134	SOL6 SOL7 SOL8	MODULE, SOLENOID, DISENGAGING ROLLER	3
3	7715291	S22 S23 S24	SENSOR AND BRACKET ASSY	3
4	7717410		SPRING, TRANSPORT IDLER ROLLERS	6
5	7715384		HANDLE ASSY, IDLER PANELS	1
6	7715382		BEARING HOUSING ASSY	6
7	7715625		WIRE SADDLE, SHORT	3
8	7715629		SCREW, BARREL, M4, 7MM DEEP	12
9	7715639		WIRE SADDLE, SM, SIDE OPEN	8
10	7715874		PANEL WELDMENT, IDLER, EXIT	1
11	7714679		GROUND STRAP, M4	1
12	7708163		CAP, RUBBER	1

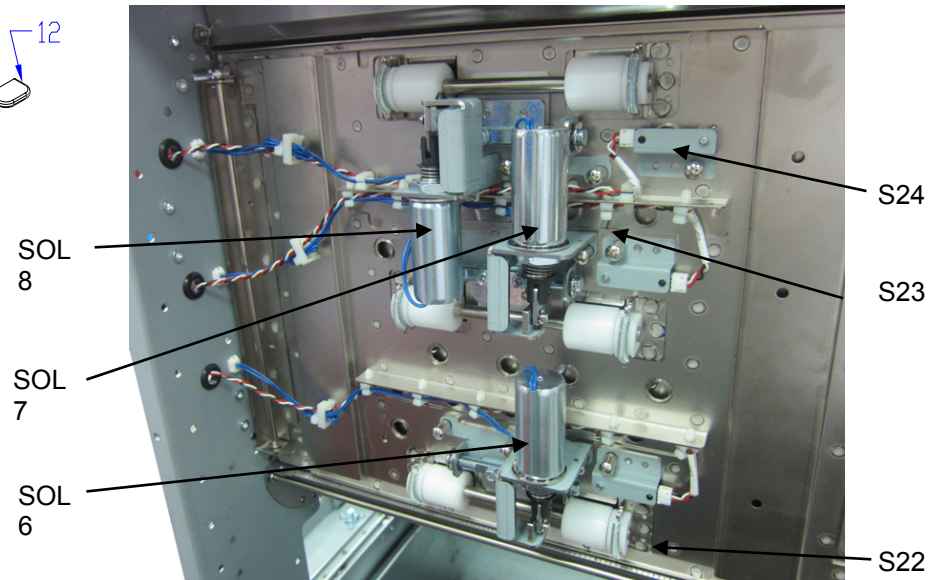

PL 3.5. Paper Path- Upper Bypass Panel

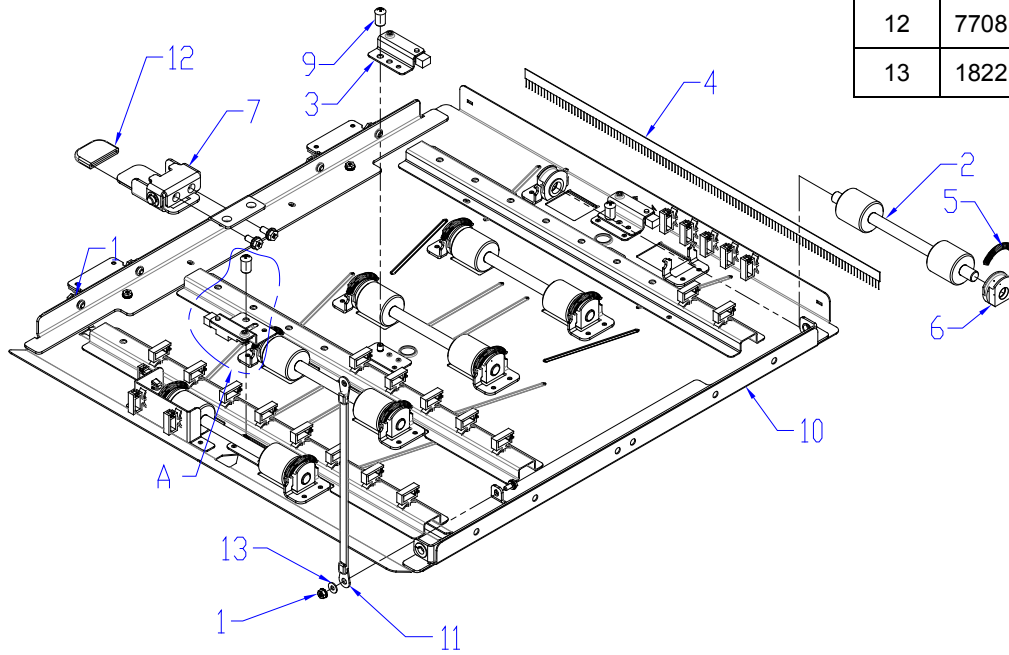
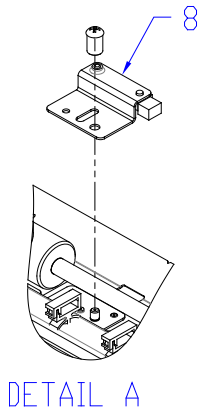

ITEM	GBC Part #		DESCRIPTION	QTY
1	1824002		NUT, KEPS, M3	1
2	7715103		ROLLER ASSY, IDLER	5
3	7715291	S25 S26	SENSOR AND BRACKET ASSEMBLY	2
4	7718594		BRUSH, ANTI-STATIC	1
5	7717410		SPRING, TRANSPORT IDLER ROLLER	10
6	7715382		BEARING HOUSING ASSY	10
7	7715384		HANDLE ASSY, IDLER PANELS	1
8	7715627	S1	SENSOR AND BRACKET ASSY,S1	1
9	7715629		SCREW, BARREL, M4, 7MM DEEP	3
10	7715872		PANEL WELDMENT, BYPASS, UPPER	1
11	7714679		GROUND STRAP, M4	1
12	7708163		CAP, RUBBER	1
13	1822117		WASHER, 3.2ID, 8OD, 0.75MM THICK	1

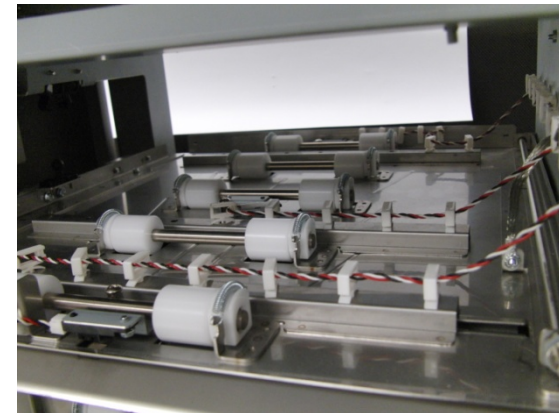

PL 3.6. Paper Path- Disengaging Roller Solenoid

ITEM	GBC Part #		Description	QTY
1	7724134	SOL 3 SOL 4 SOL 5 SOL 6 SOL 7 SOL 8	MODULE, SOLENOID, DISENGAGING ROLLER	6

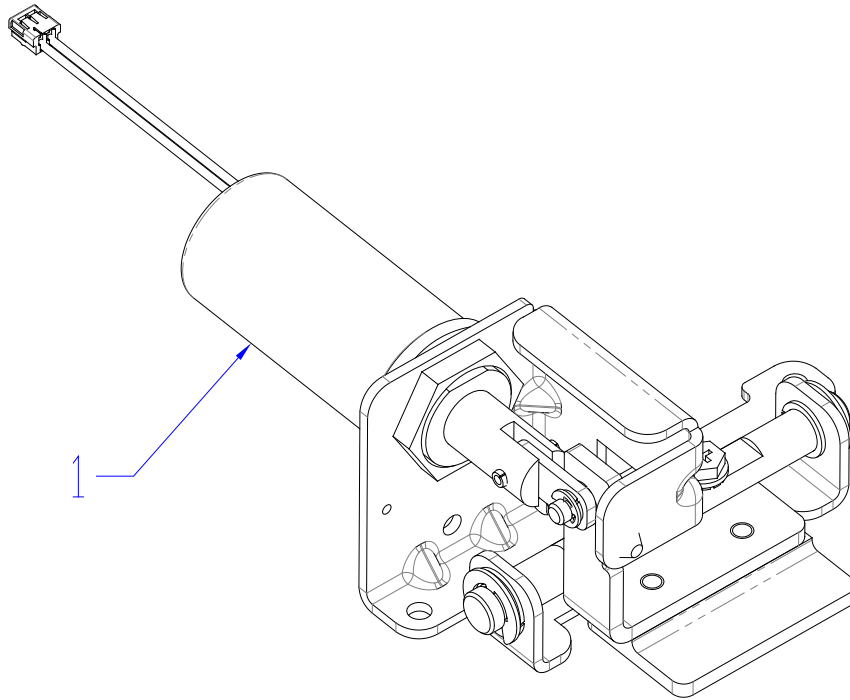

Punch Module

PL 4.1. Punch Module

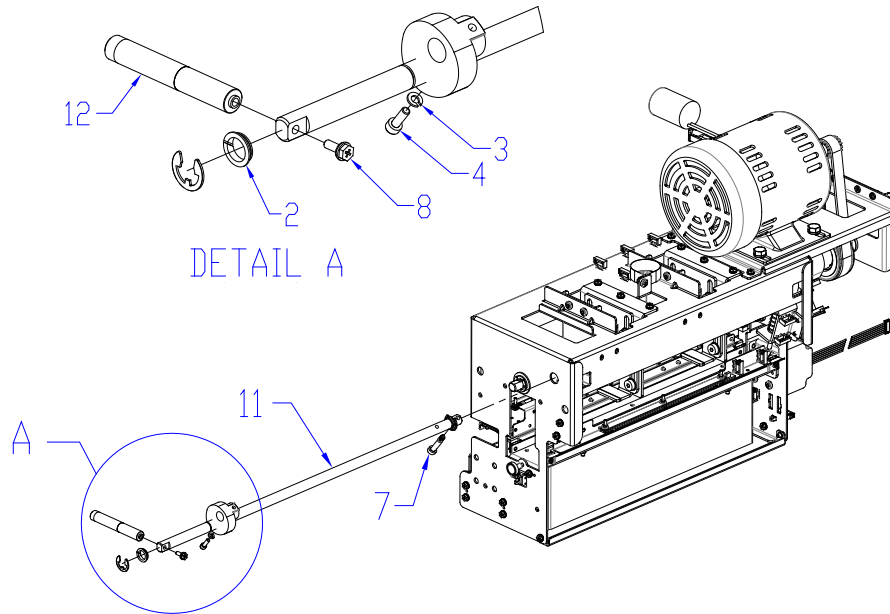

ITEM	GBC Part #		DESCRIPTION	QTY
	7723650	115V	PUNCH MODULE, ASSY, 115V	1
	7723651	230V	PUNCH MODULE, ASSY, 230V	1
1	1821118		BEARING,BALL,FLANGE,12X24X6,SUJ2	3
2	1821215		BEARING, CLIP, 12MM	2
3	1821802		Spring washer M4	2
4	1821532		SCREW, SHCS, M4 X 12	2
5	1822016		WASHER,NYLON, ID12.7, OD19, 1.5THK	2
6	1822205		E-RING, JE-10	5
7	1823203		SCREW, SOCKET, M5, 6MM SHOULDER	1
8	1823911		SCREW, PHILLIPS W/SEMS M4X10	1
9	1824003		NUT, KEPS, M6	1
10	7715033		STEERING MODULE SUB ASSY	1
11	7715237		SHAFT, DIE LOCK	1
12	7715368		HANDLE, DIE LOCK	1
13	7715818		WIRE SADDLE,MEDIUM,LOCK TOP,V-0	1
14	7715886		PUNCH MODULE SHELL, SERVICE	1

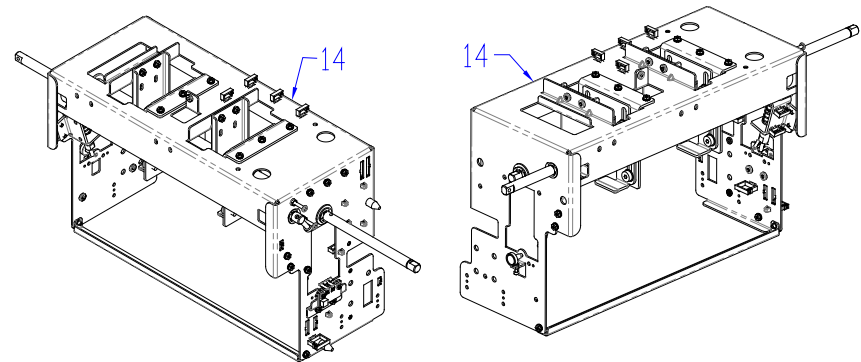
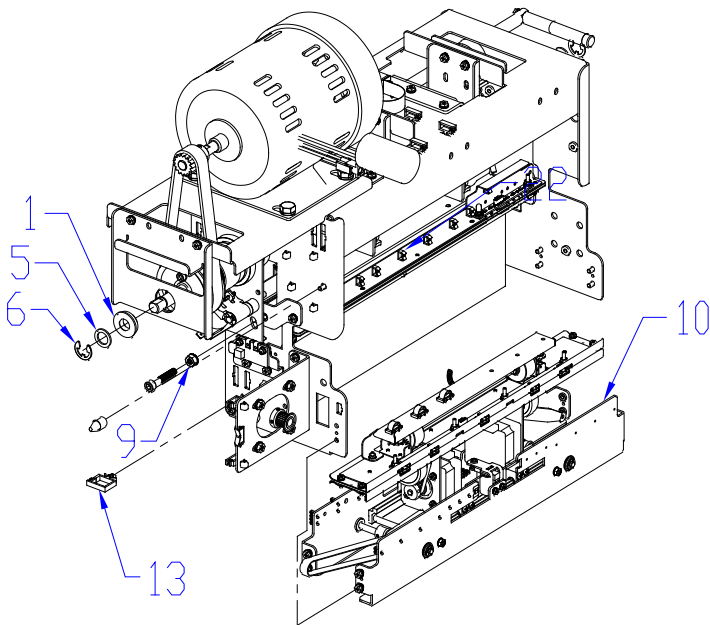

PL 4.2. Punch Module (continued)

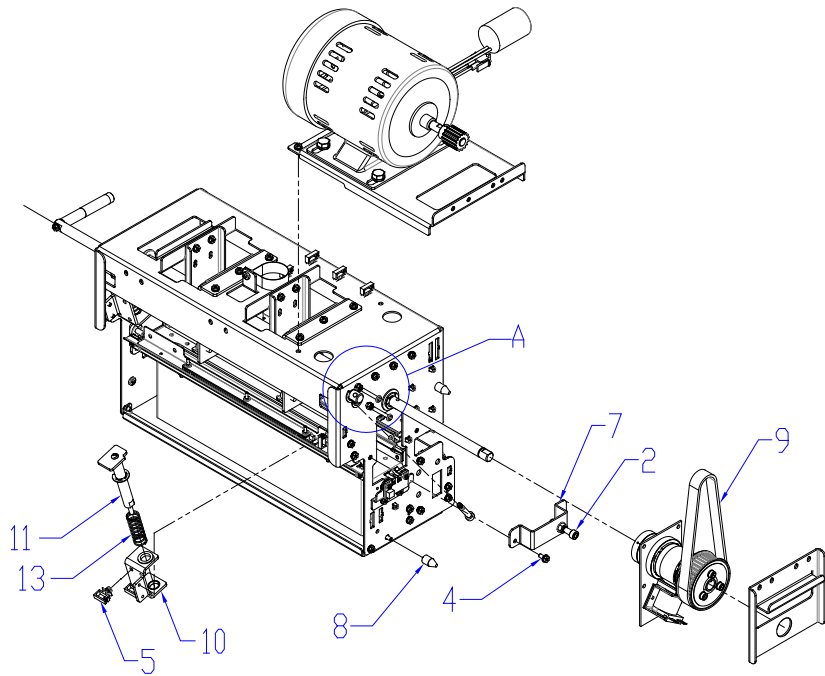

ITEM	GBC Part #		DESCRIPTION	QTY
1	1821514		SHCS, M3X12	1
2	1821541		SCREW, SOCKET HD,M6,35MM LONG	1
3	1821655		SCREW, PHILLIPS, PAN HD, M4X25	2
4	1823903		SCREW, PHILLIPS, HX HD M4X8	54
5	1825203		WIRE SADDLE, SNAP TYPE, SMALL	2
6	1823701		NUT, HEX, M3	1
7	7715030		BRACKET, CLUTCH STUD	1
8	7715079		MOUNT PIN, PUNCH MODULE	2
9	7715232	115V	BELT, TIMING, 82 GROOVE, 5MM HTD	1
	7715372	230V	BELT, TIMING, 80 GROOVE, 5MM HTD	1
10	7715238		BRACKET & BEARING ASSY,DIE LOCK	2
11	7715239		PLUNGER & STRIPPER ASSY,DIE LOCK	2
12	7715320		MAGNET, DIE STOP	1
13	7715374		SPRING, DIE LOCK RETURN	2
14	1824001		NUT, KEPS M4	2

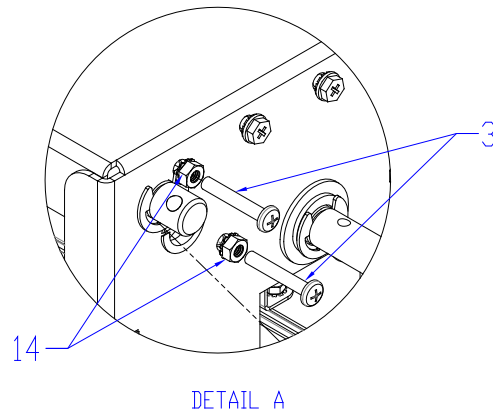
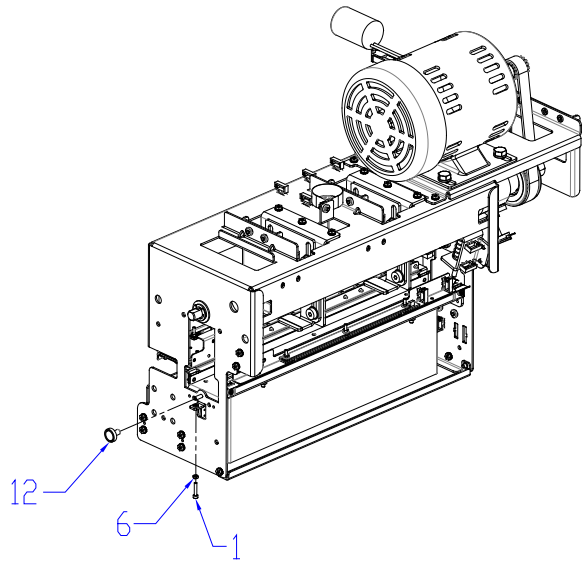

PL 4.3. Punch Module- Motors/Sensors

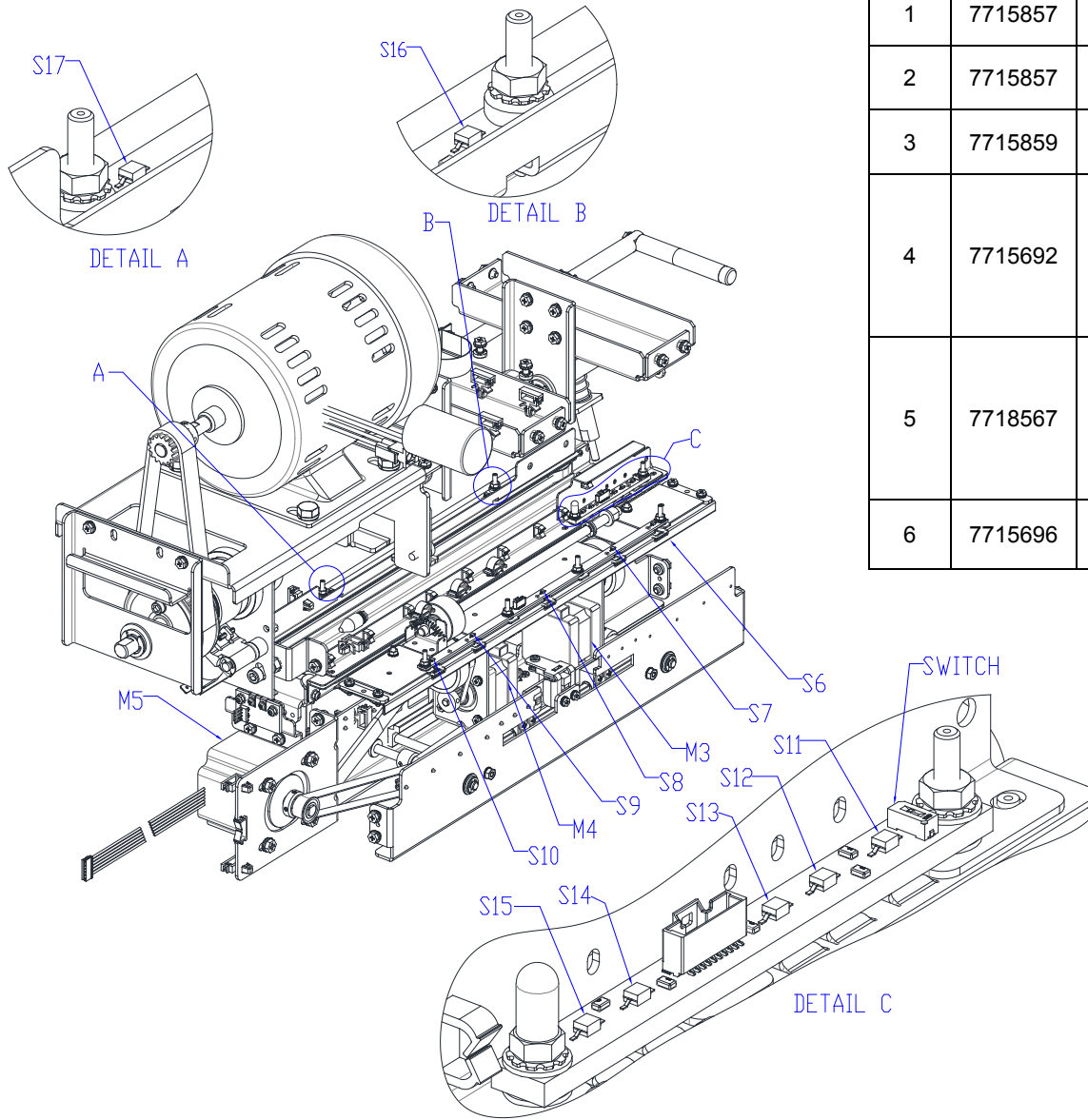

ITEM	GBC Part #		DESCRIPTION	QTY
1	7715857	M3	LEFT / FRONT STEERING MOTOR AND PULLEY.	1
2	7715857	M4	RIGHT / REAR STEERING MOTOR AND PULLEY.	1
3	7715859	M5	ALIGNMENT STEPPER MOTOR AND PULLEY.	1
4	7715692	S6 S7 S8 S9 S10	SKEW SENSOR BOARD	1
5	7718567	S11 S12 S13 S14 S15	ALIGNMENT SENSOR BOARD, SWITCHABLE	1
6	7715696	S16 S17	BACKAGE SENSOR BOARD	1

PL 4.4. Punch Module- Steering Module

ITEM	GBC Part #		DESCRIPTION	QTY
1	1823901		SCREW, PHILLIPS HX W/SEMS, M3X6	4
2	1823913		SCREW,PHILIPS-HEX LOCK, M3X8	4
3	1824002		NUT, KEPS, M3	1
4	7715445		WIRE CLAMP, EDGE, SMALL	1
5	7715597	S28	SENSOR, VEIN, BRACKET, SUB ASSLY	1
6	7715779		GROUND STRAP, STEERING CARRIAGE	1
7	7715877		ALIGNMENT CARRIAGE,SUB ASSY, SERVICE	1

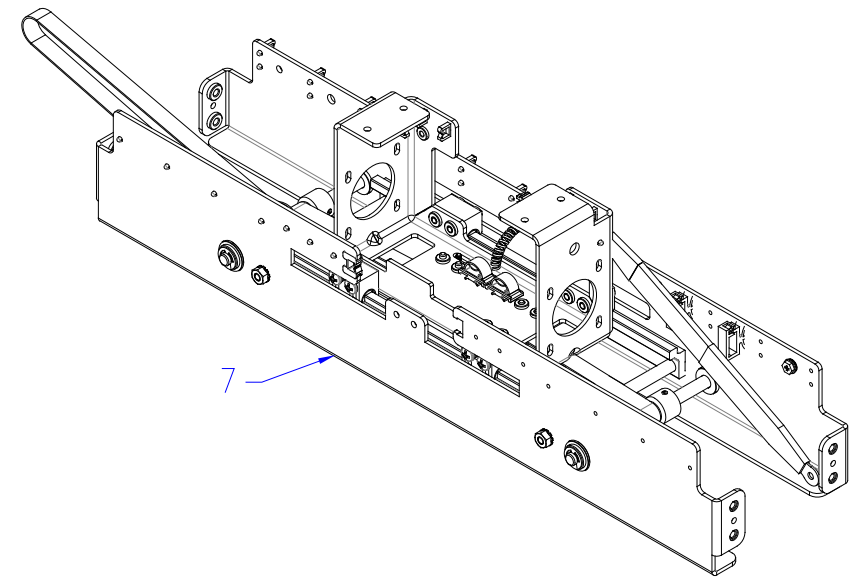
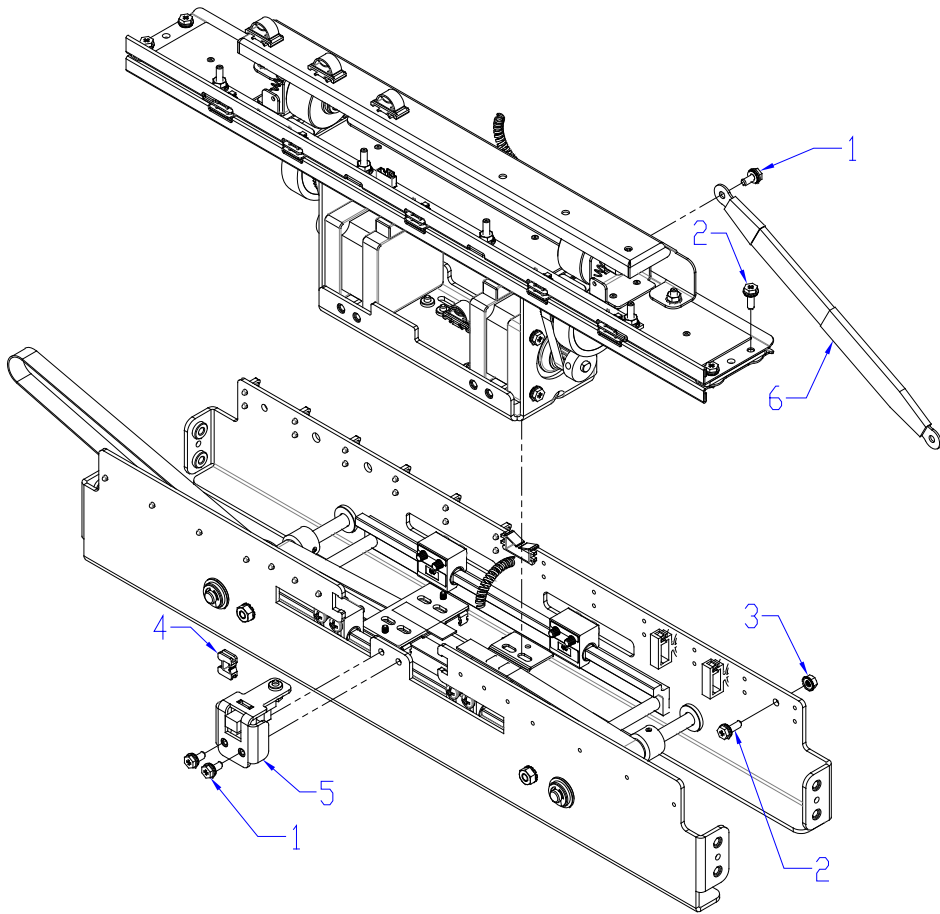

PL 4.5. Punch Module- Steering Module - Steering Idler Panel Sub Assembly

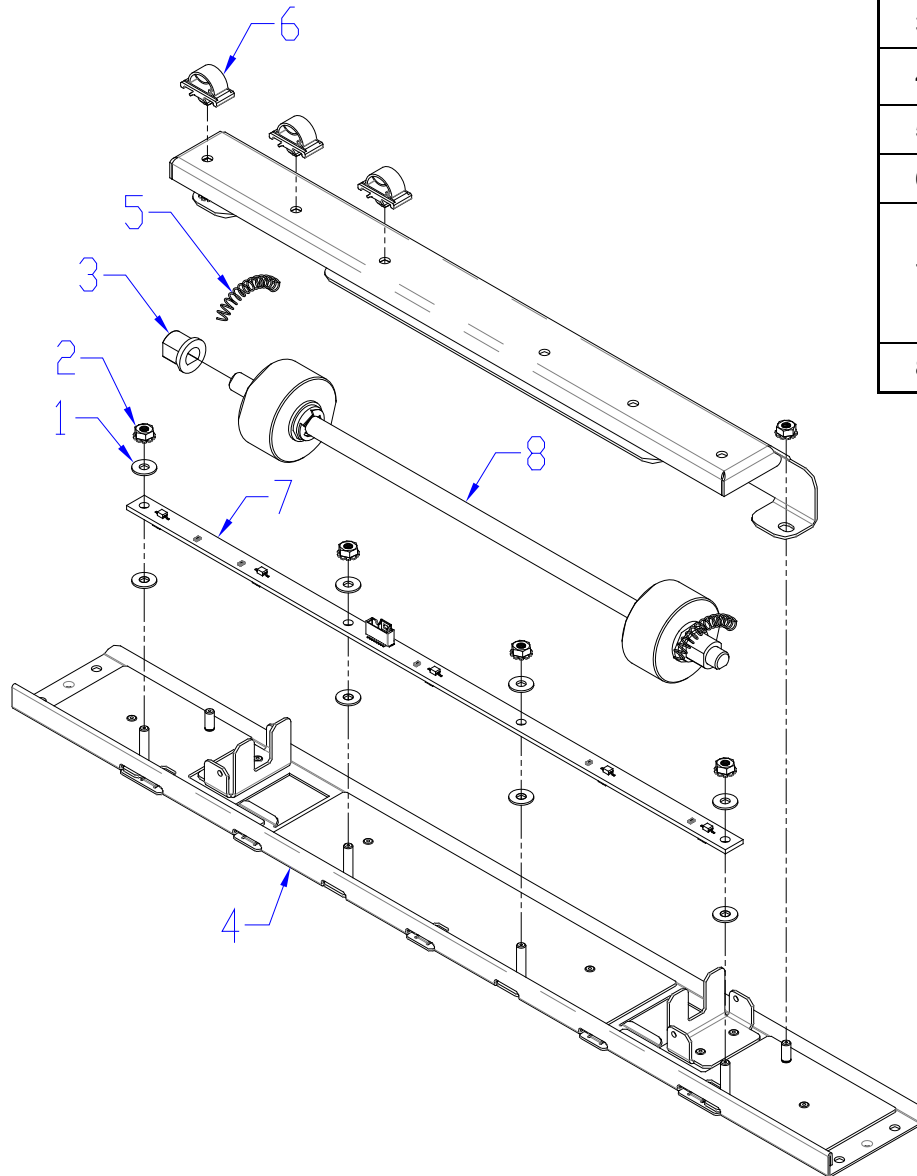

ITEM	GBC Part #		DESCRIPTION	QTY
1	1822117		WASHER, 3.2ID, 8OD, 0.75MM THK	8
2	1824002		NUT, KEPS, M3	6
3	7706488		BEARING, DOUBLE "D" FLANGE	2
4	7715062		PANEL WELDMENT, IDLER, STEERING	1
5	7717410		SPRING, STEERING IDLER ROLLER	2
6	7715648		WIRE CLAMP, LOCKING	3
7	7715692	S6 S7 S8 S9 S10	BOARD ASSY, SKEW SENSOR	1
8	7715816		ROLLER ASSY, IDLER, STEERING	1

PL 4.6. Punch Module- Steering Module - Drive Panel Steering

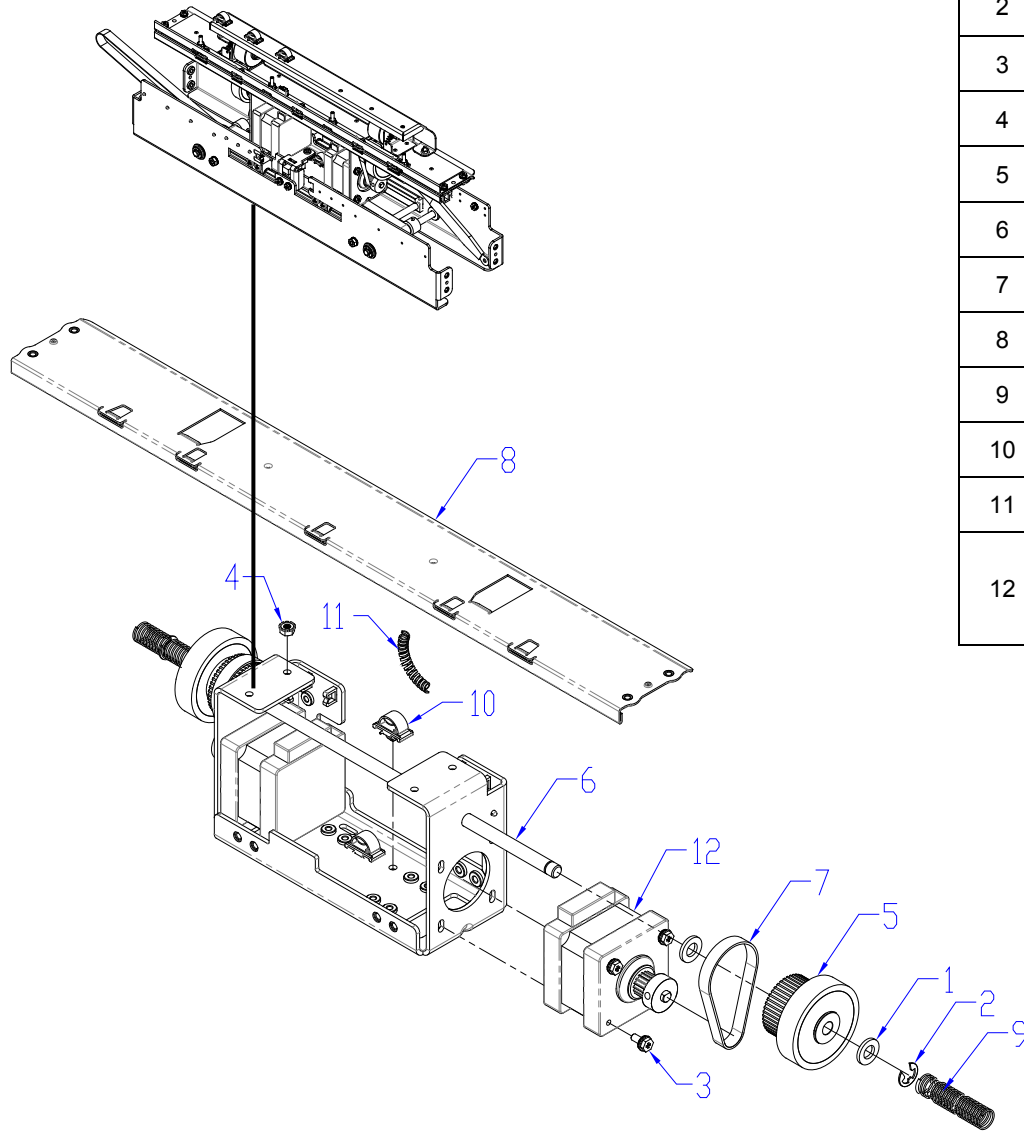

ITEM	GBC Part #		DESCRIPTION	QTY
1	1822008		WASHER, FLAT, 6.4X12X1.5	4
2	1822202		E-RING, JE-5	4
3	1823901		SCREW, PHILLIPS HX W/SEMS, M3X6	8
4	1824002		NUT, KEPS, M3	4
5	7715039		ROLLER ASSEMBLY, DRIVE, STEERING	2
6	7715044		SHAFT, STEERING DRIVE	1
7	7715047		BELT,STEERING,65 GROOVES,2MM 2GT	2
8	7715053		PANEL WELDMENT, DRIVE, STEERING	1
9	7715377		SPRING, STEERING DRIVE ROLLER	2
10	7715648		WIRE CLAMP, LOCKING	2
11	7715777		SLEEVE, SPIRAL, MOTOR WIRES	1
12	7715857	M3	STEPPER MOTOR AND PULLEY, STEERING, SERVICE	1
	7715857	M4	STEPPER MOTOR AND PULLEY, STEERING, SERVICE	1

PL 4.7. Punch Module- Stepper Alignment Bracket

ITEM	GBC Part #		DESCRIPTION	QTY
1	1823906		SCREW,PHILLIPS HX W/SEM M5X10	4
2	7715078		BRACKET,ALIGN STEPPER MOUNT	1
3	7715859	M5	STEPPER MOTOR AND PULLEY, ALIGNMENT, SERVICE	1

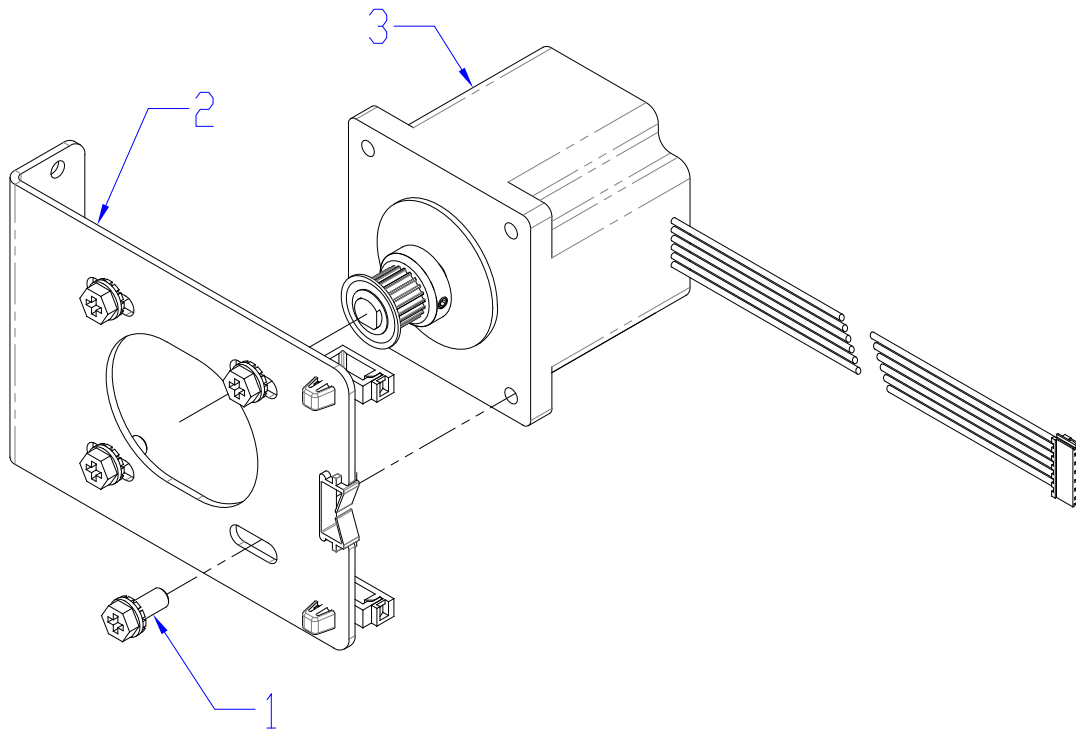

PL 4.8. Punch Module- Punch Clutch

ITEM	GBC Part #		DESCRIPTION	QTY
1	1821531		SCREW, SHCS, M5X18	3
2	1821801		WASHER, SPLIT LOCK, M5	3
3	7715020		CLUTCH, WRAP SPRING	1
4	7715231	115V	PULLEY & FLANGE,5MM HTD,38T	1
	7715371	230V	PULLEY & FLANGE,5MM HTD,34T	1

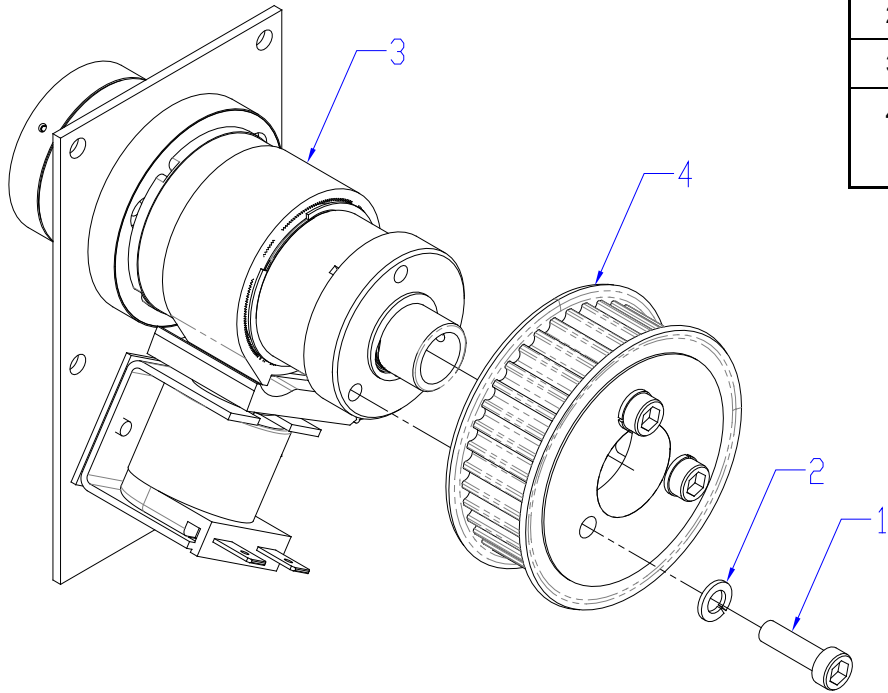

PL 4.9. Punch Module- Die Set Recognition Reader Board

ITEM	GBC Part #	DESCRIPTION	QTY
1	7715347	BOARD, READER, DIE SET RECOGNITION	1
2	1824002	NUT, KEPS, M3	2

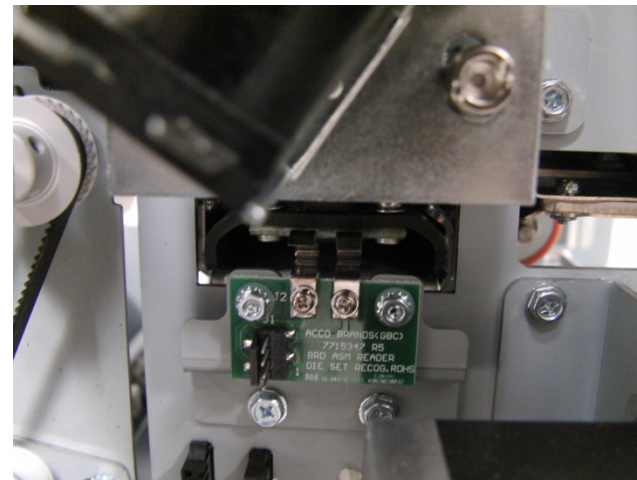
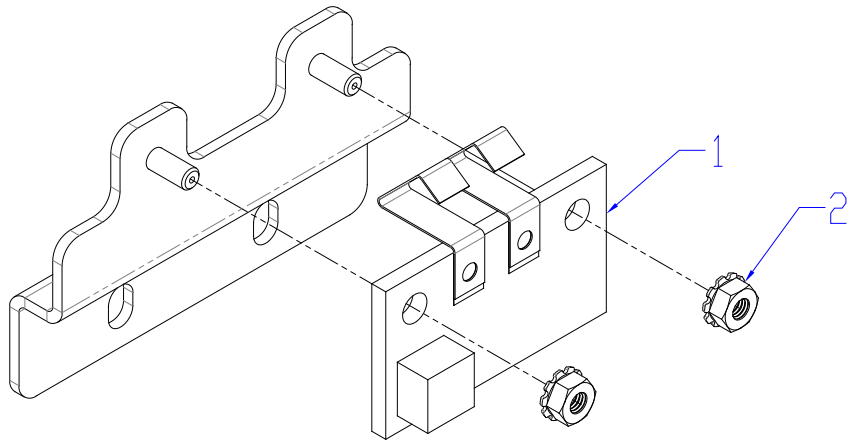

PL 4.10. Punch Module- Die Rail, Backgage, Align Sensors, Sub Assembly

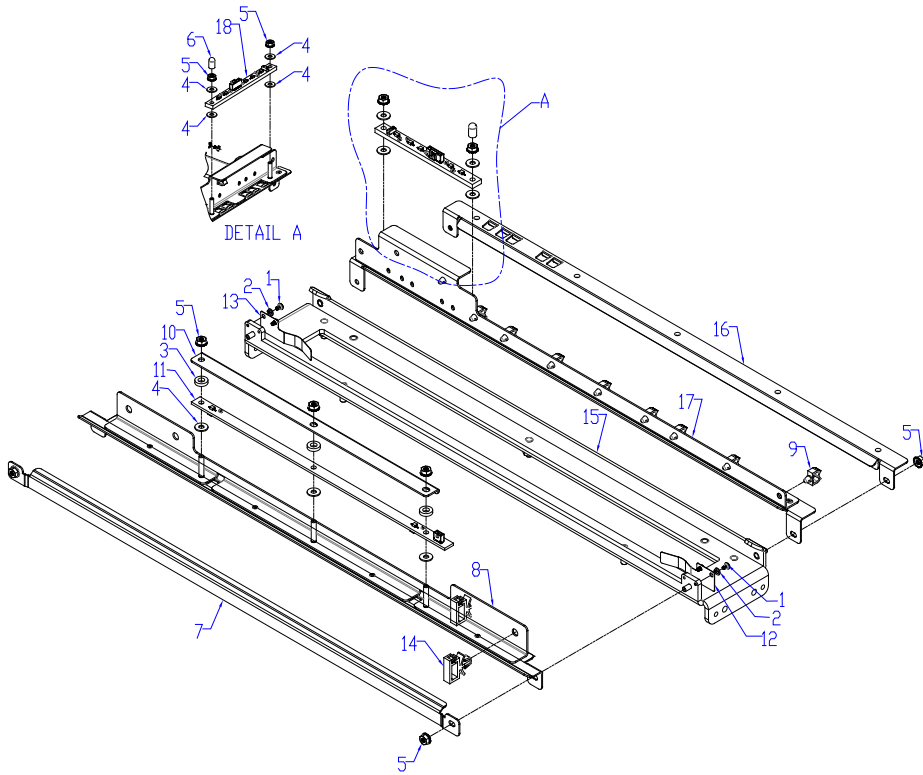

ITEM	GBC Part #		DESCRIPTION	QTY
1	1821610		SCREW, PHILLIPS, PAN HD, M2, 3MM	4
2	1821808		LOCK WASHER, SPLIT, M2	4
3	1822114		WASHER, FLAT, 4.1x8x2	3
4	1822117		WASHER, 3.2ID, 8OD, 0.75MM THK.	7
5	1824002		NUT, KEPS, M3	9
6	7708814		CAP, RUBBER, 1/8 X 1/4 X .040	1
7	7715032		BRACKET, BACKGAGE SENSOR, LOWER	1
8	7715080		BRACKET WLDMNT, BACKGAGE SENSOR	1
9	7715640		WIRE SADDLE, SHORT, ALIGN SENSOR WIRES	9
10	7715645		COVER, BACKGAGE SENSOR	1
11	7715787	S16 S17	BOARD ASSY, BACKGAGE SENSOR	1
12	7715799		SPRING, DIE RAIL, POSITION, 1	1
13	7715817		SPRING, DIE RAIL, POSITION, 2	1
14	7715986		WIRE SADDLE, SMALL, LOCKING TOP, V-0	2
15	7715988		DIE RAIL, ASSEMBLY	1
16	7715990		GUIDE, ALIGNMENT SENSOR, BOTTOM	1
17	7715787		BRACKET WLDMNT, ALIGNMENT SENSOR	1
18	7718567	S11 S12 S13 S14 S15	BOARD ASSY, ALIGNMENT SENSOR, SWITCHABLE	1

PL 4.11. Punch Module- AC Motor

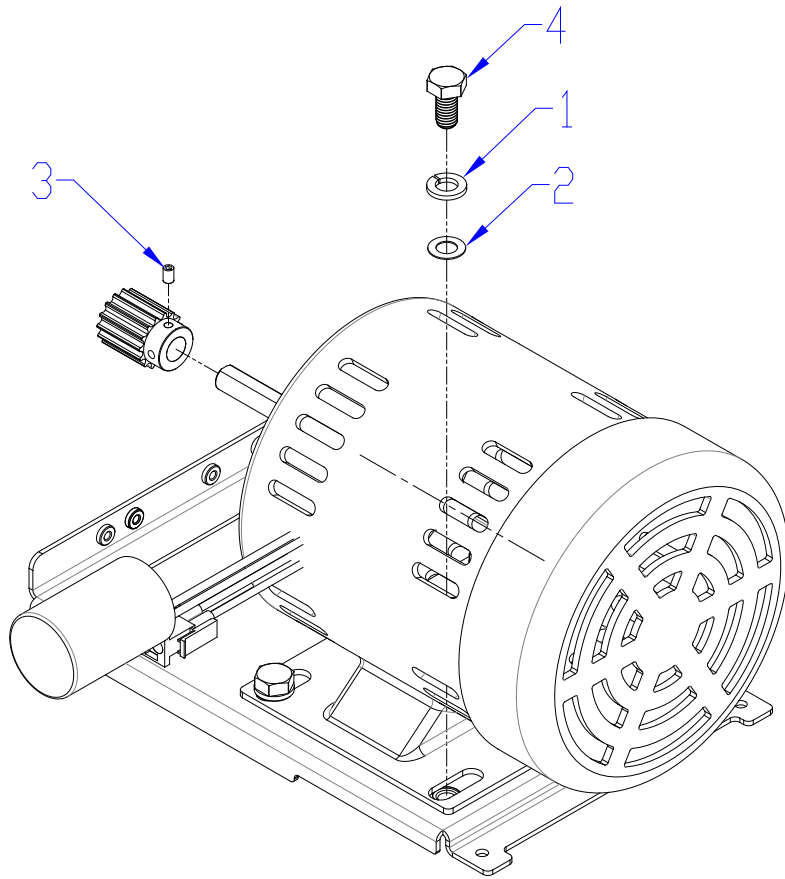

ITEM	GBC Part #		DESCRIPTION	QTY
1	1821807		WASHER, SPLIT LOCK, M8	4
2	1822113		WASHER, FLAT, 8X14X0.5	4
3	1823602		SET SCREW, NYLON PATCH, M4X6	1
4	1824703		SCREW, HEX CAP, M8, 16MM LONG	4
5	7724220	115V	MOTOR AND PULLEY, PUNCH, 0.5HP, 115V, SERVICE	1
	7724221	230V	MOTOR AND PULLEY, PUNCH, 0.5 HP, 230V, SERVICE	1

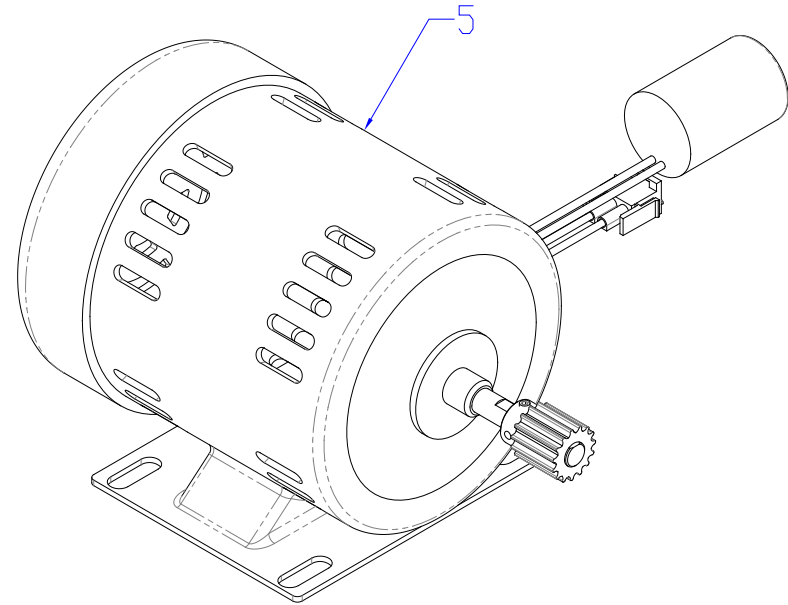

Die Sets

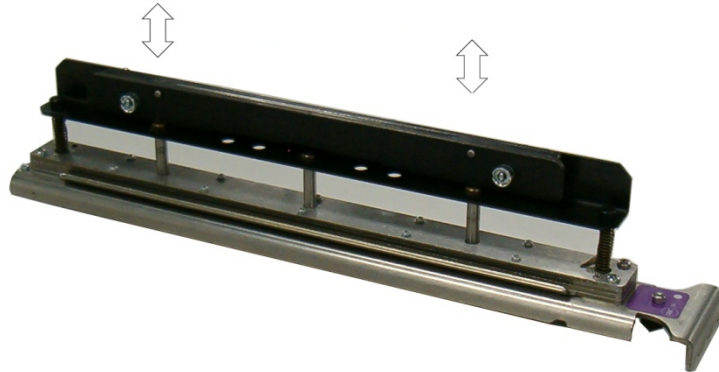

ORDER THESE DIE-SETS THROUGH PLOCKMATIC SUPPLIES

ITEM	DESCRIPTION	GBC Part Number
1	DIE, Coil, Rnd	7723470A
2	DIE, Wire 2:1, Rnd	7723471A
3	DIE, Wire 3:1, Rnd	7723484A
4	DIE, 3 Hole, 8mm	7723473A
5	DIE, 3/5/7 Hole, 8mm	7723474A
6	DIE, 4 Hole, 8mm	7723475A
7	DIE, 4 Hole, 6.5mm	7723476A
8	DIE, 4 Hole Scan	7723477A
9	DIE, VeloBind®, 11 Hole, Ltr	7723478A
10	DIE, VeloBind®, 12 Hole, A4	7723479A
11	DIE, CombBind	7723480A
12	DIE, Wire 2:1, Sq	7723481A
13	DIE, Wire 3:1, Sq	7723485A
14	DIE, Coil, Oval	7723483A
15	DIE, Coil, Rnd, 47H HD	7723486A
16	DIE, 3 Hole, 8mm, HD	7723487A
17	DIE, CombBind, 21H HD	7723488A
18	DIE, eWire, Round	7723484A
19	DIE, eWire, Square	7723485A
20	DIE, Perforation, 75-120 gsm	WSM7724164
21	DIE, Perforation, 120-300 gsm	WSM7724165
22	Die, CREASE	WSM7724163

Electronics

PL 6.1. Electronics PCB Assembly

ITEM	GBC Part #	DESCRIPTION	QTY
1	6195001	RFI POWER FILTER	1
2	7723460	BOARD, CONTROL, MAIN	1
3	7718799	BOARD, CONTROL, COMM	1

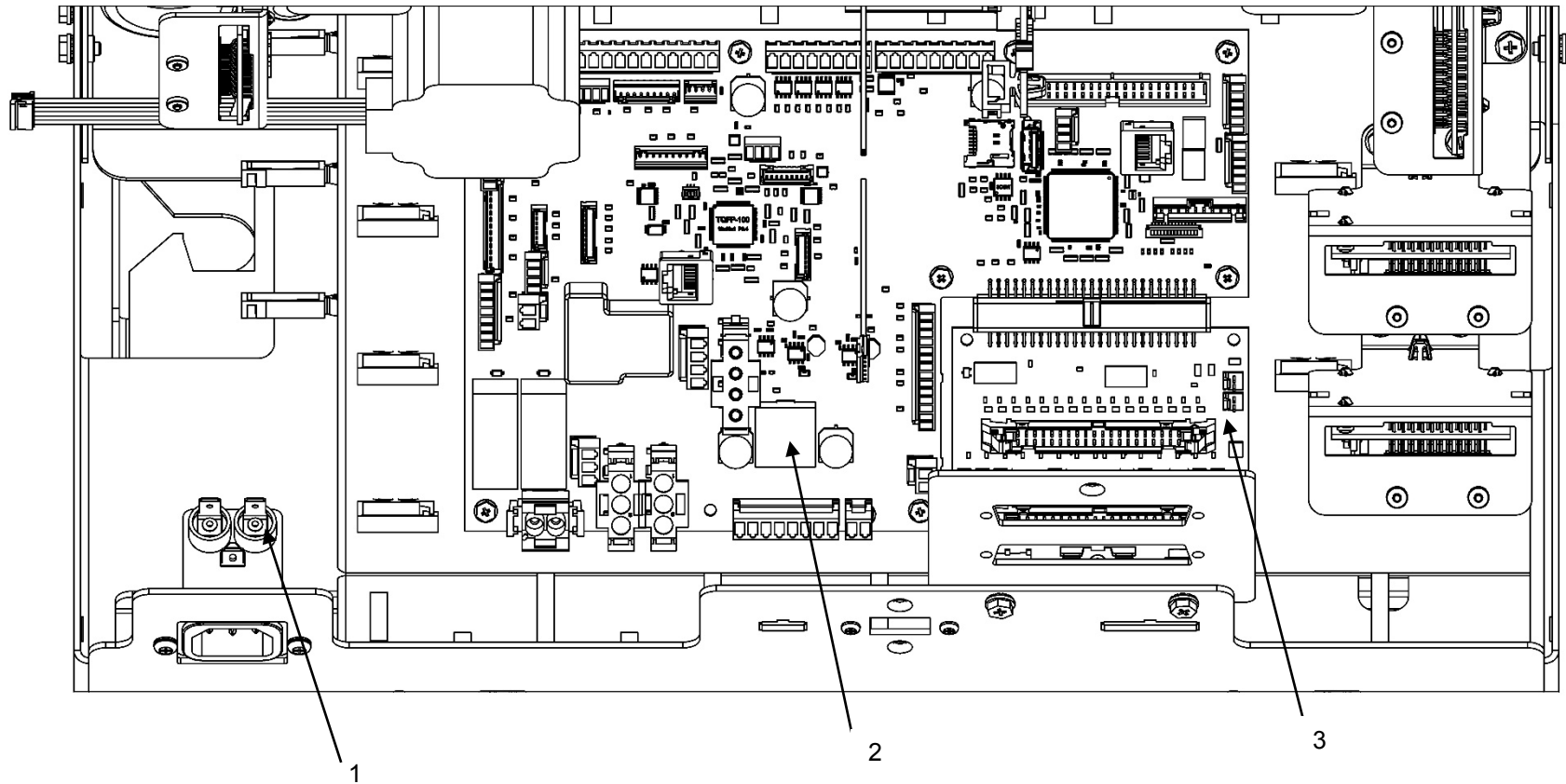

PL 6.2. Control Board Bracket Sub Assembly

ITEM	GBC Part #	DESCRIPTION	QTY
1	7715817	WIRE SADDLE, SMALL, LOCKING	8
2	7715819	WIRE SADDLE, LARGE, LOCKING	23

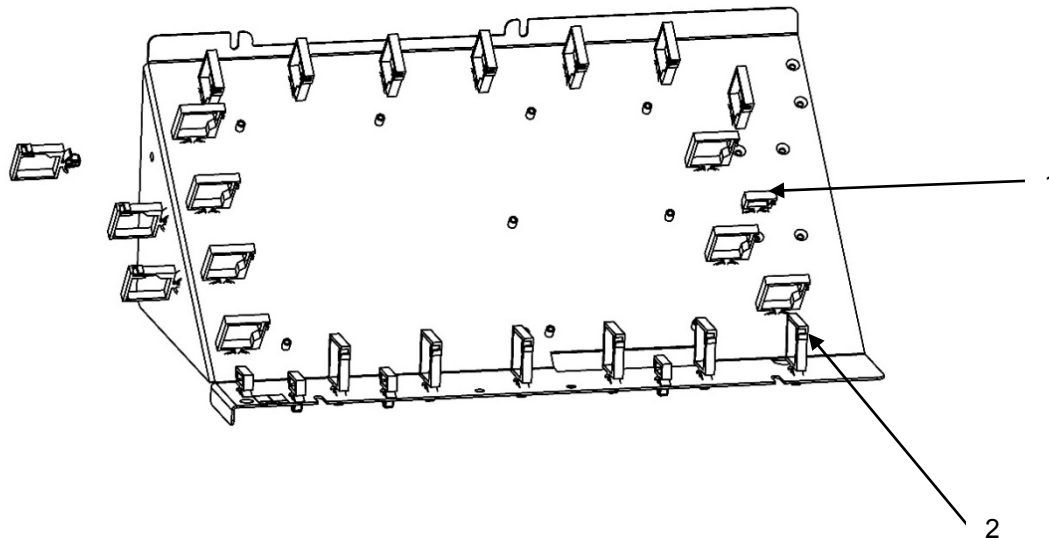
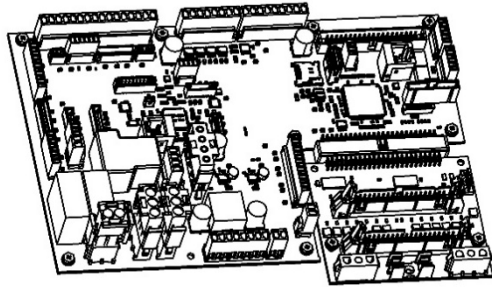

PL 6.3. Cable Part Number Index

Refer to the Wiring drawing on the next page to locate the cables

GBC Part #	DESCRIPTION
7715451	CABLE, SENSORS S1,S25,S26
7715453	CABLE, SENSORS, ENTRY
7715455	CABLE, SENSORS, SKEW, BRD TO HDR
7715456	CABLE, SENSORS, ALIGN, BRD TO HDR
7715457	CABLE, SENSORS, BG & ALGN HM, BRD TO HDR
7715458	CABLE, SENSORS, MID BG L & XL
7715459	CABLE, SENSORS, EXIT
7715466	CABLE, SOLENOIDS, ENTRY, BRD TO HDR
7715467	CABLE, SOLENOIDS, EXIT, BRD TO HDR
7715468	CABLE, ENTRANCE & ACCEL, DRIVER
7715470	CABLE, ALIGN & STEERING, DRIVER
7715473	CABLE, EXIT, DECEL & BYPASS DRIVER
7715476	CABLE, PUNCH MOTOR
7715477	CABLE, POWER, STEPPER, DRIVERS
7715485	CABLE, CHIP TRAY
7715487	CABLE, DOOR INTERLOCK
7715490	CABLE, USB
7715492	CABLE, DC POWER
7715493	CABLE, AC TO PSU
7715494	CABLE, AC TO BOARD

7715495	CABLE, DIESET RECOGNITION
7715535	CABLE, INLET FILTER TO AC SWITCH
7715508	CABLE, SKEW, HDR TO SENSOR
7715509	CABLE, ALIGN, HDR TO SENSOR
7715510	CABLE, BG, HDR TO SENSOR
7715519	CABLE, ALIGN HOME, HDR TO SENSOR
7715520	CABLE, LEFT STEER, DRV TO HDR
7715521	CABLE, RIGHT STEER, DRV TO HDR
7715523	CABLE, LCD
7715525	CABLE, AC FILTER, GROUND
7715528	CABLE, STEERING MOTOR, MTR TO HDR, LEFT
7715529	CABLE, STEERING MOTOR, MTR TO HDR, RIGHT
7715536	CABLE, THRU BEAM, CLEAR COVER
7715537	CABLE, DEBUG TO PANEL
7715539	CABLE, GROUND, PSU TO CHASSIS
7715538	CABLE, COMM TO PANEL
7715531	CABLE, DFA, UPSTREAM, SPARTA

PL 6.4. Wiring Drawing

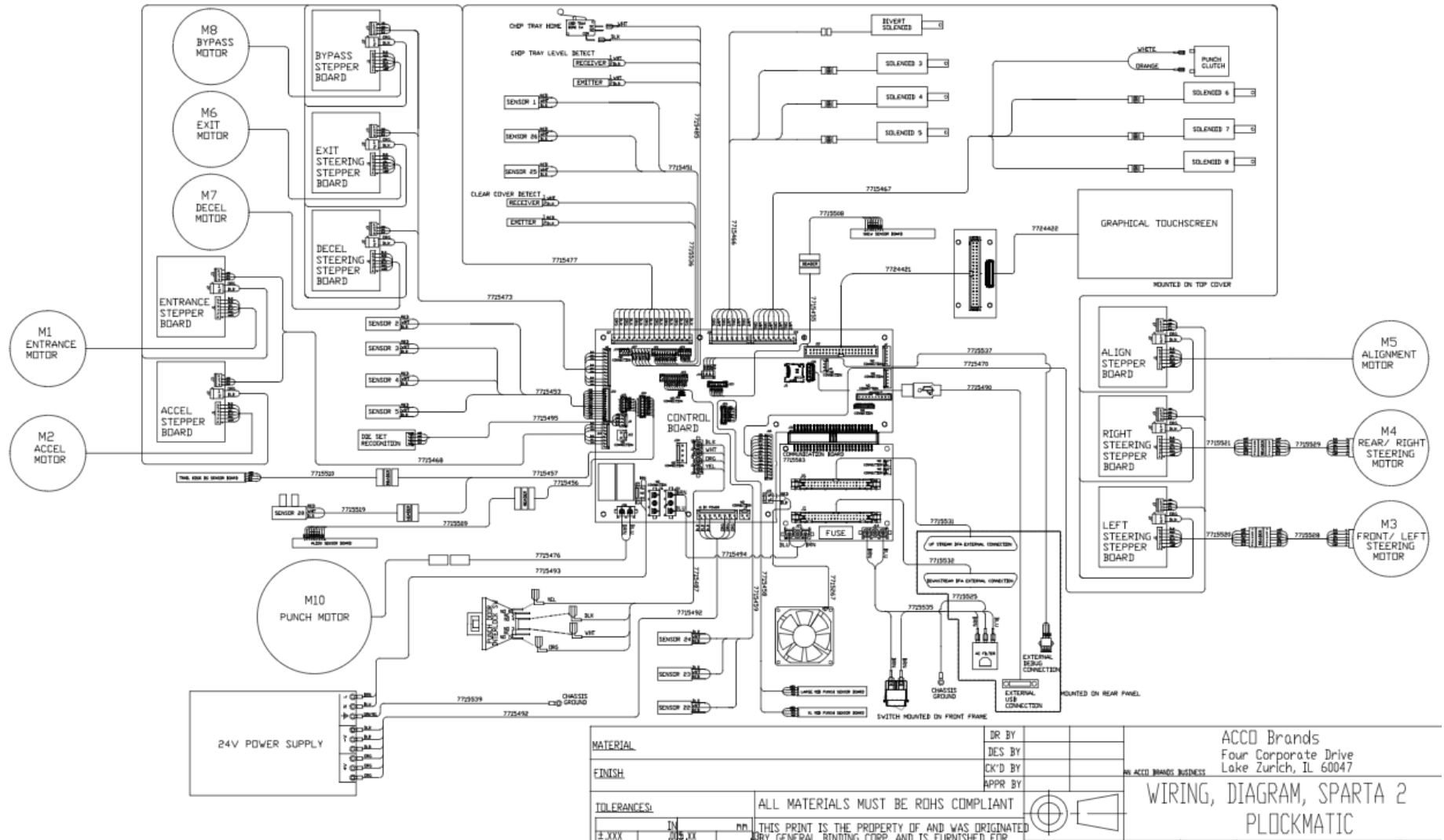

MATERIAL	DR BY		ACCO Brands Four Corporate Drive Lake Zurich, IL 60047 AN ACCO BRANDS BUSINESS
FINISH	DES BY		
	CK'D BY		
TOLERANCES:	APPR BY		WIRING, DIAGRAM, SPARTA 2 PLOCKMATIC
ALL MATERIALS MUST BE ROHS COMPLIANT THIS PRINT IS THE PROPERTY OF AND WAS ORIGINATED BY GENERAL BINDING CORP. AND IS FURNISHED FOR			

PCB'S Main Control Board and Communication Board

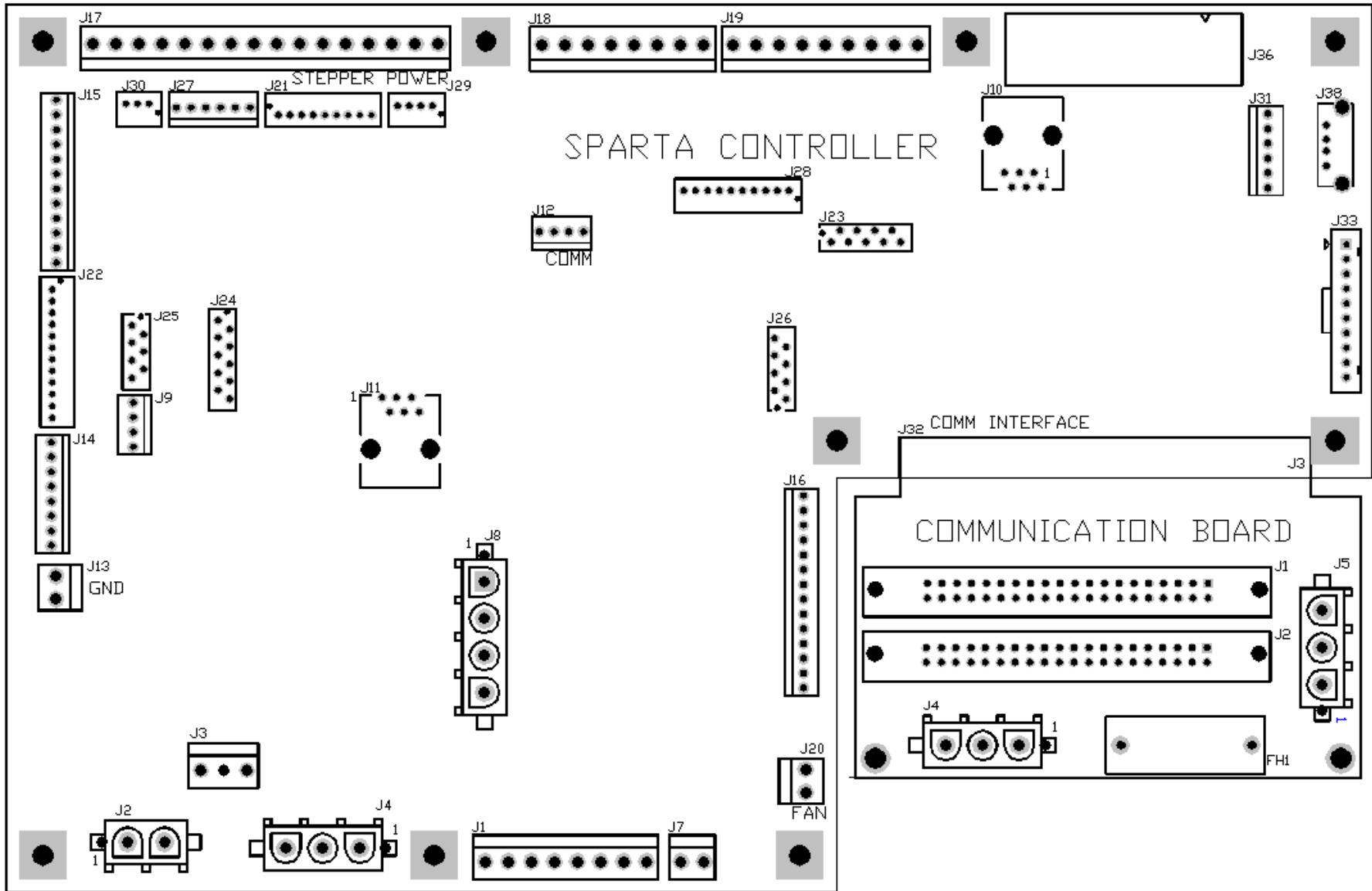

Installation Kit Parts

ITEM	GBC Part #	APPLICABLE MODELS	DESCRIPTION	QTY
1	6200001	115V	POWER CORD, US, 115V	1
2	6200002	230V	POWER CORD, EUROPE	1
3	6200014	230V	POWER CORD, UK,	1
4	6200015	230V	POWER CORD, SWISS	1
5	7610500	115V/230V	CABLE ASSY INTERFACE (37 PINS)	2
6	125-114318	115V/230V	DOCKING MALE 602	1

Part Number Index

Part #	DESCRIPTION	PL
7723423	COVER, TOP, ASSEMBLY	1.2
7715670	FOAM, TOP COVER	1.2
7715759	BRACKET, FRONT DOOR HINGE, TOP	1.2
7706486	LATCH, PUSH TO CLOSE, SOUTHCO	1.2
7610501	INTERLOCK SWITCH	1.2
7715793	BRACKET, INTERLOCK SWITCH, SPARTA	1.2
7723426	DOOR, FRONT, ASSEMBLY, SPARTA	1.2
7723419	COVER, SIDE, UPSTREAM	1.2
7715195	MAGNET, PANEL, OPEN, STRONG	1.2
7715761	BRACKET, DOOR HINGE, BOTTOM, FRAME	1.2
7723418	COVER, REAR, ASSEMBLY, SPARTA	1.2
7715575	EXHAUST FAN, BRACKET, ASSY, SPARTA	1.2
7723420	COVER, WELDMENT, SIDE, DOWNSTREAM	1.2
7715267	FAN, EXHAUST	1.2
7723442	COVER, SIDE, DOWNSTREAM, FRONT	1.2
PL 5.5	UPPER BYPASS PANEL	2.1
PL 5.2	ENTRANCE IDLER PANEL	2.1
PL 5.1	ENTRANCE DRIVE PANEL	2.1
PL 5.3	ACCELERATION IDLER PANEL	2.1
PL 5.4	EXIT IDLER PANEL	2.1
7715101	PANEL, ENTRANCE, LOWER	2.1
7715102	PANEL, ENTRANCE, INNER	2.1
7715146	PANEL, EXIT, LOWER	2.1
7715153	PANEL, EXIT, INNER	2.1
7724137	PANEL ASSEMBLY, LOWER, EXIT	2.1
7715209	SHAFT, IDLER PANEL HINGE	2.1
7715210	SHAFT, IDLER PANEL HINGE, LONG	2.1
7715251	BRACKET, IDLER PANEL MOUNT	2.1
7715150	PANEL WELDMENT, DRIVE, EXIT	2.1
7715128	PANEL WELDMENT, BYPASS, LOWER	2.1
1821209	SNAP-IN BEARING, 6MM ID [Qty. (2) used on all Idler panels- #A, #B, #D, #E and #5	2.1

Part #	DESCRIPTION	PL
7718619	SHAFT, IDLER PANEL, WITH GROOVE, EXIT SIDE	2.1
1821209	Snap-in Bearing, 6mm ID for 1.45-2.34 mm Thk Mtrl	2.2
1822202	E-RING, JE-5	2.2
1823711	JAM NUT, M16X2.0	2.2
1823901	SCREW, PHILLIPS HX HD W/SEMS, M3 X 6	2.2
1823909	SCREW, PHILLIPS HX HD W/SEMS M4 X 6	2.2
1824001	NUT, KEPS M4	2.2
1821606	SCREW, PHILLIPS PAN HD W/SEMS M3 X 10	2.2
7715195	MAGNET, PANEL, OPEN, STRONG	2.2
7715215	HANDLE, ACCEL IDLER LATCH	2.2
7715385	MAGNET, BRACKET, ASSY	2.2
7715427	CHIP TRAY, ASSEMBLY	2.2
7715650	LATCH, BYPASS	2.2
7715637	POWER SUPPLY, 24V, MW SP 480,	2.2
7715789	MAGNET, PANEL, OPEN, WEAK	2.2
7708163	CAP, RUBBER, RAIN BLUE	2.2
7715630	CASTER, ADJUSTABLE	2.2
1823913	SCREW, PHILLIPS HX HD W/SEMS M3 X 8	2.2
1821209	Snap-in Bearing, 6mm ID	2.3
1821611	SCREW, PHILLIPS HD W/SEMS, M3X10	2.3
1822005	WASHER, FLAT, 6.025 X 8 X 0.75	2.3
1822202	E-RING, JE-5	2.3
1823910	SCREW, PHILLIPS HX HD W/SEMS M4 X 14	2.3
1824001	NUT, KEPS M4	2.3
1825501	RETAINING RING, 6MM SHAFT	2.3
1902863	SCREW, MACHINE PAN #4-40 X 15/32 PHILLIPS	2.3
1925044	WSHR, .192 ID X .625 OD X .060 T	2.3
1952208	SPACER, TIMING BELT IDLERS, BRONZE	2.3
1954011	GROMMET, 3/8 I.D X 1/2 O.D	2.3
1954032	GROMMET, 1 1/4 I.D. X 1 1/2 O.D.	2.3
7712703	WIRE HEADER CONNECTOR, 2 POS	2.3
7714679	GROUND STRAP, M4	2.3
7715185	BRACKET, PUNCH MODULE MOUNT	2.3
7715383	ROLLER, IDLER, DRIVE ASSY,	2.3
7715390	WIRE CLAMP, EDGE	2.3

Part #	DESCRIPTION	PL
7715445	WIRE CLAMP, EDGE, SMALL	2.3
7715813	SOLENOID, BRACKET, DIVERTER, SUB ASSEMBLY	2.3
7715818	WIRE SADDLE, MEDIUM, LOCKING TOP, V-0	2.3
7715819	WIRE SADDLE, LARGE, LOCKING TOP, V-0	2.3
7715817	WIRE SADDLE, SMALL, LOCKING TOP, V-0	2.3
7715093	ROLLER ASSY, DRIVE	2.4
7715097	ROLLER ASSY, ONE WAY CLUTCH DRIVE	2.4
1821116	BEARING, BALL, FLANGE 6X13X5, SUJ2	2.4
1822005	WASHER, FLAT, 6.025 X 8 X 0.75	2.4
1822202	E-RING, JE-5	2.4
7706532	BEARING BALL FLANGE	2.4
1925222	WASHER FLAT, NON-METALLIC 1/4X3/8X1/32	2.4
7715862	ONE WAY CLUTCH SUB ASSEMBLY, SERVICE	2.4
1822108	WASHER, FLAT, 4.1X8X1.5	2.5
1823911	SCREW, PHILLIPS HX HD W/SEMS M4 X 10	2.5
7711970	EMITTER	2.5
7711973	RECEIVER	2.5
7715131	BYPASS DIVERTER	2.5
7715186	CHIP TRAY SENSOR MOUNT ASSY	2.5
7715213	SHAFT, ACCEL IDLER LATCH	2.5
7724141	LATCH, ASSY, REAR, ACCEL IDLER PANEL	2.5
7724140	LATCH, ASSY, FRONT, ACCEL IDLER PANEL	2.5
7715637	POWER SUPPLY, 24V, MW SP 480,	2.5
7715159	STEPPER AND MOUNT ASSEMBLY	2.6
7715275	DRIVER AND BRACKET ASSY, TWO PHASE	2.6
7715627	Entrance Sensor, S1	2.7
7715291	Entrance Sensor, Top	2.7
7715291	Entrance Sensor, Middle	2.7
7715291	Entrance Sensor, Bottom	2.7
7715291	Accel Sensor	2.7
7715692	Skew Sensor Board	2.7
7718567	Alignment Sensor Board, Switchable	2.7
7715696	Backage Sensor Board Assy	2.7
7715696	Mid Punch Large, Sensor Board Backage Sensor Board Assy	2.7
7715696	Mid Punch X- Large, Sensor Board Backage Sensor Board Assy	2.7
7715291	Exit Sensor, Bottom	2.7

Part #	DESCRIPTION	PL
7715291	Exit Sensor, Middle	2.7
7715291	Exit Sensor, Top	2.7
7715291	Exit Sensor	2.7
7715291	Bypass Sensor, Middle	2.7
7715597	Align Home Sensor	2.7
7711970	Chip Level Sensor - Emitter	2.7
7711973	Chip Level Sensor - Receiver	2.7
7715774	Clear Cover Sensor - Emitter	2.7
7711973	Clear Cover Sensor - Receiver	2.7
7715813	Divertter Subassembly	2.8
7715020	Punch Clutch	2.8
7724133	Entrance Idler Solenoid, Middle	2.8
7724133	Entrance Idler Solenoid, Bottom	2.8
7724133	Acceleration Roller Solenoid	2.8
7724133	Exit Idler Solenoid, Bottom	2.8
7724133	Exit Idler Solenoid, Middle	2.8
7724133	Exit Idler Solenoid, Top	2.8
7610501	Front door Interlock Switch	2.8
7715186	Chip Tray Home Switch Assembly	2.8
7715202	BELT, 534T, 2MM 2GT	2.9
7715204	PULLEY, TIMING, 2MM 2GT, 30 GROOVES	2.9
7715206	BELT, 179T, 2MM 2GT	2.9
7715243	BELT, 150 T, 2MM 2GT	2.9
7715245	TENSIONER ASSEMBLY	2.9
7715246	BELT, 134T, 2MM 2GT	2.9
1824002	NUT, KEPS, M3	3.1
7711973	RECEIVER	3.1
7715696	MID PUNCH, LARGE, SENSOR BOARD BOARD ASSY, BACKGAGE SENSOR	3.1
7715696	MID PUNCH, X LARGE, SENSOR BOARD BOARD ASSY, BACKGAGE SENSOR	3.1
7715871	PANEL WELDMENT, DRIVE, ENTRANCE, SERVICE	3.1
1822108	WASHER, FLAT, 4.1X 8X1.5	3.1
1822117	WASHER, 3.2ID, 8OD, 0.75MM THICK	3.1
1823903	SCREW, PHILLIPS, HX HD M4X8	3.1
7711970	EMITTER	3.2
7715103	ROLLER ASSY, IDLER	3.2
7724133	MODULE, SOLENOID, DISENGAGING ROLLER	3.2
7715291	SENSOR AND BRACKET ASSEMBLY	3.2

Part #	DESCRIPTION	PL
7717410	SPRING, TRANSPORT IDLER ROLLERS	3.2
7715382	BEARING HOUSING	3.2
7715384	HANDLE ASSY, IDLER PANELS	3.2
7715625	WIRE SADDLE, SHORT	3.2
7715629	SCREW, BARREL, M4, 7MM THREAD DEPTH	3.2
7715639	WIRE SADDLE, SMALL, SIDE OPENING	3.2
7715873	PANEL WELDMENT, IDLER, ENTRANCE, SERVICE	3.2
7714679	GROUND STRAP, M4	3.2
7708163	CAP, RUBBER	3.2
7708163	CAP, RUBBER	3.3
7715103	ROLLER ASSY, IDLER	3.3
7724133	MODULE, SOLENOID, DISENGAGING ROLLER	3.3
7715291	SENSOR AND BRACKET ASSEMBLY	3.3
7718626	BRUSH, ANTI STATIC	3.3
7717410	SPRING, TRANSPORT IDLER ROLLERS	3.3
7715382	BEARING HOUSING ASSY	3.3
7715817	WIRE SADDLE, SMALL, LOCKING TOP	3.3
7715629	SCREW, BARREL, M4, 7MM THREAD DEPTH	3.3
7718628	PANEL WELDMENT, IDLER, ACCEL	3.3
7714679	GROUND STRAP, M4	3.3
7715103	ROLLER ASSY, IDLER	3.4
7724134	MODULE, SOLENOID, DISENGAGING ROLLER	3.4
7715291	SENSOR AND BRACKET ASSEMBLY	3.4
7717410	SPRING, TRANSPORT IDLER ROLLERS	3.4
7715384	HANDLE ASSY, IDLER PANELS	3.4
7715382	BEARING HOUSING ASSY	3.4
7715625	WIRE SADDLE, SHORT	3.4
7715629	SCREW, BARREL, M4, 7MM THREAD DEPTH	3.4
7715639	WIRE SADDLE, SMALL, SIDE OPENING	3.4
7715874	PANEL WELDMENT, IDLER, EXIT,-SERVICE	3.4
7714679	GROUND STRAP, M4	3.4
7708163	CAP, RUBBER	3.4
1824002	NUT, KEPS, M3	3.5
7715103	ROLLER ASSY, IDLER	3.5
7715291	SENSOR AND BRACKET ASSEMBLY	3.5
7718594	BRUSH, ANTI-STATIC	3.5
7717410	SPRING, TRANSPORT IDLER ROLLERS	3.5
7715382	BEARING HOUSING ASSY	3.5
7715384	HANDLE ASSY, IDLER PANELS	3.5
7715627	SENSOR AND BRACKET ASSEMBLY, S1	3.5
7715629	SCREW, BARREL, M4, 7MM THREAD DEPTH	3.5

Part #	DESCRIPTION	PL
7715872	PANEL WELDMENT, BYPASS, UPPER, SERVICE	3.5
7714679	GROUND STRAP, M4	3.5
7708163	CAP, RUBBER	3.5
1822117	WASHER, 3.2ID, 8OD, 0.75MM THICK	3.5
7724134	Module, Solenoid, Disengaging Roller	3.6
7723650	PUNCH MODULE, ASSY, 115V	4.1
7723651	PUNCH MODULE, ASSY, 230V	4.1
1821118	BEARING, BALL, FLANGE, 12X24X6, SUJ2	4.1
1821215	BEARING, CLIP, 12MM	4.1
1821802	Spring washer M4	4.1
1821532	SCREW, SHCS, M4 X 12	4.1
1822016	WASHER, NYLON, ID 12.7, OD 19, 1.5MM THK	4.1
1822205	E-RING, JE-10	4.1
1823203	SCREW, SHOULDER, SOCKET HD, M5, 6MM SHOULDER	4.1
1823911	SCREW, PHILLIPS HX HD W/SEMS M4 X 10	4.1
1824003	NUT, KEPS, M6	4.1
7715033	STEERING MODULE SUB ASSY	4.1
7715237	SHAFT, DIE LOCK	4.1
7715368	HANDLE, DIE LOCK	4.1
7715818	WIRE SADDLE, MEDIUM, LOCKING TOP, V-0	4.1
7715886	PUNCH MODULE SHELL, SERVICE	4.1
1821514	SHCS, M3X12	4.1
1821541	SCREW, SOCKET HD, M6, 35MM LONG	4.1
1821655	SCREW, PHILLIPS, PAN HD, M4X25	4.1
1823903	SCREW, PHILLIPS, HX HD M4X8	4.1
1825203	WIRE SADDLE, SNAP TYPE, SMALL, 3mm	4.1
1823701	NUT, HEX, M3	4.1
7715030	BRACKET, CLUTCH STUD	4.1
7715079	MOUNT PIN, PUNCH MODULE	4.1
7715232	BELT, TIMING, 82 GROOVE, 5MM HTD	4.1
7715372	BELT, TIMING, 80 GROOVE, 5MM HTD, 15MM WIDE	4.1
7715238	BRACKET AND BEARING ASSY, DIE LOCK	4.1
7715239	PLUNGER AND STRIPPER ASSY, DIE LOCK	4.1
7715320	MAGNET, DIE STOP	4.1
7715374	SPRING, DIE LOCK RETURN	4.1
1824001	NUT, KEPS M4	4.1
7715857	Left / Front Steering Motor and Pulley.	4.2
7715857	Right / Rear Steering Motor and Pulley.	4.2
7715859	Alignment Stepper Motor and Pulley.	4.2

Part #	DESCRIPTION	PL
7715692	Skew Sensor Board	4.2
7718567	Alignment Sensor Board	4.2
7715696	Backage Sensor Board	4.2
1823901	SCREW, PHILLIPS HX HD W/SEMS, M3 X 6	4.3
1823913	SCREW, PHILIPS-HEX HD W/EXT STAR WASHER, M3 X 8	4.3
1824002	NUT, KEPS, M3	4.3
7715445	WIRE CLAMP, EDGE, SMALL	4.3
7715597	SENSOR, VEIN, BRACKET, SUB ASSEMBLY	4.3
7715779	GROUND STRAP, STEERING CARRIAGE	4.3
7715877	ALIGNMENT CARRIAGE, SUB ASSEMBLY, RICOH, SERVICE	4.3
1822117	WASHER, 3.2ID, 8OD, 0.75MM THK.	4.4
1824002	NUT, KEPS, M3	4.4
7706488	BEARING, DOUBLE "D" FLANGE	4.4
7715062	PANEL WELDMENT, IDLER, STEERING	4.4
7717410	SPRING, STEERING IDLER ROLLERS	4.4
7715648	WIRE CLAMP, LOCKING	4.4
7715692	BOARD ASSY, SKEW SENSOR	4.4
7715816	ROLLER ASSY, IDLER, STEERING	4.4
1822008	WASHER, FLAT, 6.4X12X1.5	4.5
1822202	E-RING, JE-5	4.5
1823901	SCREW, PHILLIPS HX HD W/SEMS, M3 X 6	4.5
1824002	NUT, KEPS, M3	4.5
7715039	ROLLER ASSEMBLY, DRIVE, STEERING	4.5
7715044	SHAFT, STEERING DRIVE	4.5
7715047	BELT, STEERING, 65 GROOVES, 2MM 2GT	4.5
7715053	PANEL WELDMENT, DRIVE, STEERING	4.5
7715377	SPRING, STEERING DRIVE ROLLER	4.5
7715648	WIRE CLAMP, LOCKING	4.5
7715777	SLEEVE, SPIRAL, STEERING MOTOR WIRES	4.5
7715857	STEPPER MOTOR AND PULLEY, STEERING, SERVICE	4.5
7715857	STEPPER MOTOR AND PULLEY, STEERING, SERVICE	4.5
1823906	SCREW, PHILLIPS HX HD W/SEMS M5 X 10	4.6
7715078	BRACKET, ALIGNMENT STEPPER MOUNT	4.6
7715859	STEPPER MOTOR AND PULLEY, ALIGNMENT, SERVICE	4.6
1821531	SCREW, SHCS, M5X18	4.7
1821801	WASHER, SPLIT LOCK, M5	4.7
7715020	CLUTCH, WRAP SPRING	4.7

Part #	DESCRIPTION	PL
7715231	PULLEY AND FLANGE, 5MM HTD, 38T, ASSY	4.7
7715371	PULLEY AND FLANGE, 5MM HTD, 34T, ASSY	4.7
7715347	Board, ASM, Reader, Die Set Recognition	4.8
1824002	NUT, KEPS, M3	4.8
1821610	SCREW, PHILLIPS, PAN HD, M2, 3MM	4.9
1821808	LOCK WASHER, SPLIT, M2	4.9
1822114	WASHER, FLAT, 4.1x8x2	4.9
1822117	WASHER, 3.2ID, 8OD, 0.75MM THK.	4.9
1824002	NUT, KEPS, M3	4.9
7708814	CAP, RUBBER, 1/8 X 1/4 X .040	4.9
7715032	BRACKET, BACKGAGE SENSOR, LOWER	4.9
7715080	BRACKET WELDMENT, BACKGAGE SENSOR	4.9
7715640	WIRE SADDLE, SHORT, ALIGN SENSOR WIRES	4.9
7715645	COVER, BACKGAGE SENSOR	4.9
7715787	BOARD ASSY, BACKGAGE SENSOR	4.9
7715799	SPRING, DIE RAIL, POSITION, 1	4.9
7715817	SPRING, DIE RAIL, POSITION, 2	4.9
7715986	WIRE SADDLE, SMALL, LOCKING TOP, V-0	4.9
7715988	DIE RAIL, ASSEMBLY	4.9
7715990	GUIDE, ALIGNMENT SENSOR, BOTTOM	4.9
7715787	BRACKET WLDMNT, ALIGNMENT SENSOR	4.9
7718567	BOARD ASSY, ALIGNMENT SENSOR, SWITCHABLE	4.9
1821807	WASHER, SPLIT LOCK, M8	4.10
1822113	WASHER, FLAT, 8X14X0.5	4.10
1823602	SET SCREW, NYLON PATCH, M4X6	4.10
1824703	SCREW, HEX CAP, M8, 16MM LONG	4.10
7724220	MOTOR AND PULLEY, PUNCH, 0.5HP, 115V, SERVICE	4.10
7724221	MOTOR AND PULLEY, PUNCH, 0.5 HP, 230V, SERVICE	4.10
7723470A	DIE, Coil, Rnd	5.1
7723471A	DIE, Wire 2:1, Rnd	5.1
7723484A	DIE, Wire 3:1, Rnd	5.1
7723473A	DIE, 3 Hole, 8mm	5.1
7723474A	DIE, 3/5/7 Hole, 8mm	5.1
7723475A	DIE, 4 Hole, 8mm	5.1
7723476A	DIE, 4 Hole, 6.5mm	5.1
7723477A	DIE, 4 Hole Scan	5.1
7723478A	DIE, VeloBind®, 11 Hole, Ltr	5.1

Part #	DESCRIPTION	PL
7723479A	DIE, VeloBind®, 12 Hole, A4	5.1
7723480A	DIE, CombBind	5.1
7723481A	DIE, Wire 2:1, Sq	5.1
7723485A	DIE, Wire 3:1, Sq	5.1
7723483A	DIE, Coil, Oval	5.1
7723486A	DIE, Coil, Rnd, 47H HD	5.1
7723487A	DIE, 3 Hole, 8mm, HD	5.1
7723488A	DIE, CombBind, 21H HD	5.1
7723484A	DIE, eWire, Round	5.1
7723485A	DIE, eWire, Square	5.1
WSM77241 64	DIE, Perforation, 75-120 gsm	5.1
WSM77241 65	DIE, Perforation, 120-300 gsm	5.1
WSM77241 63	Die, CREASE	5.1
6195001	RFI POWER FILTER	6.1
7723460	BOARD, CONTROL, MAIN	6.1
7718799	BOARD, COMMUNICATION, KM	6.1
7715817	WIRE SADDLE, LARGE, LOCKING	6.2
7715819	WIRE SADDLE, LARGE, LOCKING	6.2

Revision History				
Date	Page#	PL#	Item#	Notes
12/3/2020				Initial Release

6. General Procedures and Information

Section Contents

Title	Page
General Procedures	6-3
User Interface.....	6-3
Settings.....	6-4
Information.....	6-4
Punch User Interface Screen Map	6-5
GP 6.1 User Interface Procedure.....	6-6
Settings Procedure.....	6-6
GP 6.1.1 BACKGAGE SETTING Procedure	6-7
GP 6.1.2 ALIGNMENT SETTING Procedure.....	6-7
GP 6.1.3 CLEAR COVER Procedure	6-8
GP 6.1.4 LANGUAGE SETTINGS Procedure	6-8
GP 6.1.5 UNITS Procedure.....	6-8
GP 6.1.7 INFORMATION Procedure	6-9
GP 6.1.8 DIE TYPE Procedure	6-9
GP 6.1.9 DIE CYCLES Procedure.....	6-9
GP 6.1.10 PUNCH CYCLES Procedure	6-9
GP 6.1.11 FIRMWARE Procedure.....	6-9
Crease Settings	6-10
Crease User Interface Screen Map.....	6-11
Crease Settings Procedure	6-12
GP 6.1.12 CREASE MODE SELECT Procedure.....	6-13
GP 6.1.13 CENTER CREASE ADJUST Procedure.....	6-13
GP 6.1.14 BOOK CREASE ADJUST Procedure	6-13
GP 6.1.15 C-Fold CREASE ADJUST Procedure.....	6-13
GP 6.1.16 LANGUAGE Procedure	6-13
GP 6.1.17 UNITS Procedure.....	6-13
Perforation Settings.....	6-14
Perforation User Interface Screen Map.....	6-15
Perforation Settings Procedures	6-16
GP 6.1.18 PERF MODE SELECT Procedure.....	6-17
GP 6.1.19 CENTER PERF Procedure	6-17
GP 6.1.20 SINGLE PERF Procedure	6-17
GP 6.1.21 DOUBLE PERF Procedure.....	6-17
GP 6.1.22 LANGUAGE Procedure	6-18
GP 6.1.23 UNITS Procedure.....	6-18
Service User Interface.....	6-19
Service Interface Screen Map	6-21
GP 6.2 Service User Interface Procedure.....	6-22
GP 6.2.1 PAPER SIZE Setting.....	6-23
GP 6.2.2 MAX BYPASS Setting.....	6-24
GP 6.2.3 RUN MODE Setting	6-24
GP 6.2.4 DIE CYCLES.....	6-25
GP 6.2.5 SENSORS Check	6-25
GP 6.2.6 SOLENOIDS Check.....	6-26
GP 6.2.7 MOTORS Check	6-26
GP 6.2.8 FUNCTION TESTS (Cycle Punch, Aligner Test, Fan Test).....	6-27
GP 6.2.9 SKEW OFFSETS Adjustment.....	6-28
GP 6.2.10 ALIGN OFFSETS Adjustment.....	6-30
GP 6.2.11 LOG.....	6-31
GP 6.2.12 FIRMWARE UPGRADE Procedure	6-31
GP 6.3 Undock the Punch (Moving the punch to Service position) 6-32	6-32
GP 6.4 Dock the punch	6-32
GP 6.5 Operational Inspection	6-33
GP 6.6 Internal Inspection.....	6-33
GP 6.7 Die Set Service	6-34
GP 6.7.1 Die Set Life Expectancy	6-34
GP 6.7.2 Die Set Components	6-34
GP 6.7.3 Die Set Lubrication.....	6-35
GP 6.7.4 Die Set Shoulder Bolts.....	6-36
GP 6.8 External Cleaning.....	6-37
GP 6.9 Internal Cleaning	6-37
GP 6.10 Base Cleaning.....	6-38
GP 6.11 Chip Bin Cleaning	6-38
GP 6.12 Die Guide Cleaning.....	6-39
GP 6.13 Door Latch Inspection	6-39
GP 6.14 Idler Roller and Idler Springs Inspection	6-40
GP 6.14.1 Idler Roller Cleaning.....	6-41
GP 6.14.2 Steering Idler Roller and Springs Inspection and Cleaning	6-42

GP 6.15	Drive Roller and Steering Drive Roller Inspection and Cleaning	6-43
GP 6.16	Panel Latch Inspection	6-44
GP 6.17	Optical Sensor Cleaning	6-47
GP 6.18	Bypass Paper Path Inspection and Cleaning	6-48
GP 6.19	Punch Paper Path Inspection and Cleaning	6-49
GP 6.20	Punch Drive Cam Lubrication	6-50
GP 6.21	Timing Belt Inspection	6-51
GP 6.22	Solenoid Cleaning and Inspection	6-52
GP 6.23	Alignment Carriage Rails Cleaning	6-53
GP 6.24	Punch Clutch Inspection and Cleaning	6-53
GP 6.25	Diverter Solenoid Assembly Inspection	6-54
GP 6.26	Die Set Recognition Board Clips Inspection	6-55
GP 6.27	Die Lock Mechanism and Die Rail Springs Inspection	6-55
General Information		6-57
	Principle of Operation	6-57
	Punch Path	6-57

Single Punch	6-57
Double Punch (Mid punch + trail edge punch)	6-58
Bypass Path	6-58
Glossary of Terms	6-60
Specifications	6-61
Die Sets	6-62
Die Sets List	6-63
Die Sets List (cont'd)	6-64
Tools	6-66
Standard Tools (metric)	6-66
Other Recommended Tools and Supplies	6-66
Lubrication	6-66
Cleaning Materials	6-67
Serial Numbers	6-67



General Procedures

User Interface

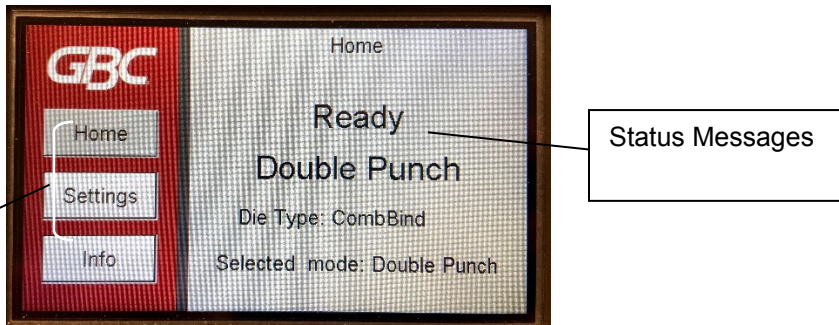
The User Interface consists of an LCD screen with options to go to HOME, SETTINGS, and INFO.



To change the settings on the User Interface:

1. From the home screen, click on SETTINGS.
 - Within each SETTINGS option, a BACK  button allows you to return to the previous menu without making any changes.
2. To properly save settings adjustments, click on the green CHECK MARK  after making any changes.

The User Interface displays status messages and fault codes on two rows of text.

In the User Interface, the top row of text displays the status of the Punch (Ready, Close Door). The bottom row of text displays the options selected on the User Interface (Single Punch).

Settings

Mode

The Mode feature allows you to choose the desired function of the machine. Mode selection options will change depending on what type of die is currently installed. For example, when a crease die is installed only Crease Mode will be available for selection.

Alignment

The Alignment feature allows you to adjust alignment settings with +/- buttons.

You can change the alignment of the paper passing through the punch inboard and outboard ± 2.0 mm.

Backgage

The Backgage feature allows you to adjust backgage settings with +/- buttons.

Saddle Punch

The Saddle Punch feature allows you to adjust the punch location settings for a saddle stitch booklet.

Full Bleed

The Full Bleed feature allows you to choose between a Tab/Full Cover option or a Full Bleed.

Clear Cover Alignment

The Clear Cover feature allows you to set the Alignment values for Clear Cover media only. This setting does not affect any other type of media.

Clear Cover Backgage

The Clear Cover feature allows you to set the Backgage values for Clear Cover media only. This setting does not affect any other type of media.

Language & Units

The Language feature allows you to select the language for the user interface. The language options are: English, Deutsch, Espanol, Francais, and Italiano.

The Units feature allows you to select the units displayed on the user interface. Select MM for millimeters or IN for inches.

Enter Service Mode

The Enter Service Mode feature allows you to complete service adjustments on the system.

Information

The User Interface allows you to view information about. Die Type, Die Cycles, Punch Cycles, and Firmware

Die Type

The Die Type feature identifies the type of Die Set installed to the Stream Punch VFX.

Die Cycles

The Die Cycles feature lists the number of punch cycles completed by the die set that is presently installed in the machine.

Punch Cycles

The Punch Cycles feature lists the number of punch cycles completed by the Punch.

Firmware

The Firmware feature identifies the level of the firmware installed to the Stream Punch VFX.

Punch User Interface Screen Map

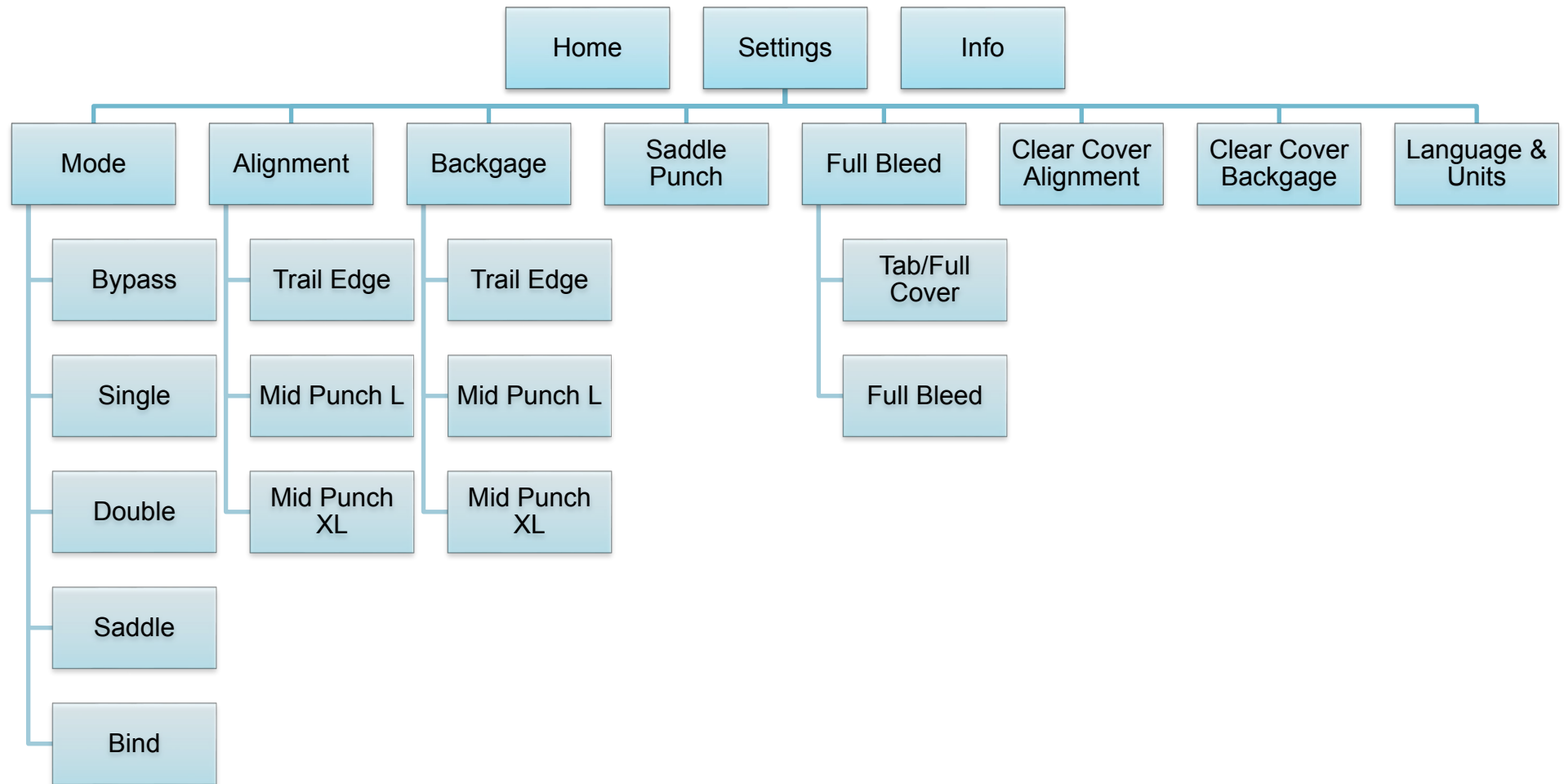

GP 6.1 User Interface Procedure

Settings Procedure

Use the following procedures to change the settings on the User Interface:

Settings

- GP 6.1.1 BACKGAGE SETTING Procedure
- GP 6.1.2 ALIGNMENT SETTING Procedure
- GP 6.1.3 CLEAR COVER Procedure
- GP 6.1.4 LANGUAGE SETTINGS Procedure
- GP 6.1.5 UNITS Procedure

Information

- GP 6.1.8 DIE TYPE Procedure
- GP 6.1.9 DIE CYCLES Procedure
- GP 6.1.10 PUNCH CYCLES Procedure
- GP 6.1.11 FIRMWARE Procedure

GP 6.1.1 BACKGAGE SETTING Procedure

Complete the following to change the Backgage (move the position of the punch holes toward or away from the trail edge of the paper).

1. From the home screen, click on SETTINGS.
 2. Select BACKGAGE.
 3. Select the desired Backgage adjustment.
 - TRAIL refers to the trail edge punch (Single Punch). The settings for backgage MID L and MID XL adjust the backgage of the double punch mode. MID L and MID XL function the same as the regular backgage depth, but adjust the position of the middle punch. MID L adjusts backgage for SEF letter and A4, while MID XL adjusts backgage for SEF 11x17 and A3
 4. Complete steps 5 - 7 to use TRAIL to adjust the Backgage for a Single Punch job.
 5. Select TRAIL EDGE.
 6. Use the +/- buttons to change the offset by ± 0.2 mm
 -
 - A + offset moves the position of the punch holes away from the trail edge of the paper (increases the Backgage depth).
 - A - offset moves the position of the punch holes toward the trail edge of the paper (decreases the Backgage depth).
 - The maximum Backgage range is 16mm (max) and 1mm (min) - distance between the trail edge and edge of the punched hole.
- Press the CHECK MARK button to enter the new Backgage value. Then, click YES to save the value.
7. To adjust the Mid Punch L/XL Backgage values select the desired adjustment within the Backgage menu.
 8. Then, complete steps 6-7.
 - To temporarily save a value until restart, click the CHECK MARK button after changing the value. Then, click NO so the value is not saved to memory. Click YES to save the value until restart

NOTE: The BACKGAGE feature has the option to save as it defines the backgage for that particular die type. This means that for any die of that type inserted into that machine, the saved backgage will apply. If the user does not save the new backgage, the next time a die of this type is inserted in the machine, it will revert to the default depth for that die.

GP 6.1.2 ALIGNMENT SETTING Procedure

Complete the following to change the Alignment (move the inboard/outboard position of the punch holes). This setting applies to all paper sizes

1. From the home screen, click on SETTINGS.
2. Select ALIGNMENT.
3. Select the desired Alignment adjustment.
 - TRAIL refers to the trail edge punch (Single Punch). The settings for Alignment MID L and MID XL adjust the Alignment of the double punch mode. MID L and MID XL function the same as the regular Alignment depth, but adjust the position of the middle punch. MID L adjusts Alignment for SEF letter and A4, while MID XL adjusts Alignment for SEF 11x17 and A3
4. Complete steps 5 - 7 to use TRAIL to adjust the Alignment for a Single Punch job.
5. Select TRAIL EDGE.
6. Use the +/- buttons to change the offset by ± 0.2 mm
 - A + offset moves the position of the punch holes toward the rear of the machine (shallower).
 - A - offset moves the position of the punch holes toward the front of the machine (deeper)..
 - The maximum alignment change is ± 2.0 mm.
7. Press the CHECK MARK button to enter the new Alignment value. Then, click YES to save the value.
8. To adjust the Mid Punch L/XL Alignment values select the desired adjustment within the Alignment menu.
9. Then, complete steps 6-7.

NOTE: The ALIGNMENT feature has the option to save as it defines the alignment for that particular die type. This means that for any die of that type inserted into that machine, the saved alignment will apply. If the user does not save the new alignment, the next time a die of this type is inserted in the machine, it will revert to the default depth for that die.

GP 6.1.3 CLEAR COVER Procedure

1. From the home screen, click on SETTINGS.
2. Use the scroll bar to navigate to the second page where the Clear Cover options are displayed.
 - For Clear Cover Backgagage, go to step 3.
 - For Clear Cover Alignment, go to step 6 .
3. To adjust the Backgagage value for Clear Cover media, press the CLEAR COVER BACKGAGAGE button.
4. Use the +/- buttons to change the offset by ± 0.2 mm increments.
 - A + offset moves the position of the punch holes away from the trail edge of the paper (increases the Backgagage depth).
 - A - offset moves the position of the punch holes toward the trail edge of the paper (decreases the Backgagage depth).
5. Press the CHECK MARK button to enter the new Backgagage value. Then, click YES to save the value.
6. To set the Alignment value for Clear Cover media, press the CLEAR COVER ALIGNMENT button.
7. Use the +/- buttons to change the offset by ± 0.2 mm increments.
 - A + offset moves the position of the punch holes toward the rear of the machine (shallower).
 - A - offset moves the position of the punch holes toward the front of the machine (deeper)..
 - The maximum alignment change is ± 2.0 mm.
8. Press the CHECK MARK button to enter the new Alignment value. Then, click YES to save the value.

GP 6.1.4 LANGUAGE SETTINGS Procedure

Do the following to select the Language mode.

1. From the home screen, click on SETTINGS.
2. Use the scroll bar to navigate to the second page. Click on LANGUAGE & UNITS.
3. Choose your desired language from the following list:
 - English
 - Espanol
 - Francais
 - Italiano
 - Deutsch

Once you have selected a language, press the CHECK MARK button. Then, click YES to save the setting.

GP 6.1.5 UNITS Procedure

Do the following to select the Units mode.

1. From the home screen, click on SETTINGS.
2. Use the scroll bar to navigate to the second page. Click on LANGUAGE & UNITS.
3. Choose your desired units from the following list:
 - Inches
 - Millimeters
4. Once you have selected a unit, press the CHECK MARK button. Then, click YES to save the setting.

GP 6.1.7 INFORMATION Procedure

Complete the following to view information about: Die Type, Die cycles, Punch Cycles, and Firmware

1. From the home screen, click on INFO
2. See the following pages for:
 - Die Type Information
 - Die Cycles Information
 - Punch Cycles Information
 - Firmware Information

GP 6.1.8 DIE TYPE Procedure

The Die Type feature identifies the type of Die Set installed to the StreamPunch VFX.

Complete GP 6.1.7 to navigate to the Information menu where the die type information is displayed.

GP 6.1.9 DIE CYCLES Procedure

The Die Cycles feature shows the number of cycles for the die set that is currently installed in the machine.

Complete GP 6.1.7 to navigate to the Information menu where the die cycles information is displayed.

GP 6.1.10 PUNCH CYCLES Procedure

The Punch Cycles feature shows the number of punch cycles for the machine.

Complete GP 6.1.7 to navigate to the Information menu where the punch cycles information is displayed.

GP 6.1.11 FIRMWARE Procedure

The Firmware feature identifies the level of the firmware installed to the StreamPunch VFX.

Complete GP 6.1.7 to navigate to the Information menu where the firmware information is displayed.

Crease Settings

Crease Mode Select

The Mode feature allows you to choose the desired function of the machine. Mode selection options will change depending on what type of die is currently installed.

Center Crease Adjust

The Center Crease Adjust feature allows you to adjust alignment settings with +/- buttons.

Book Crease Adjust

The Book Crease Adjust feature allows you to adjust crease settings when making booklets with +/- buttons.

C-Fold Crease Adjust

The C-Fold Crease Adjust feature allows you to adjust the crease location for a tri-fold sheet.

Language & Units

The Language feature allows you to select the language for the user interface. The language options are: English, Deutsch, Espanol, Francais, and Italiano.

The Units feature allows you to select the units displayed on the user interface. Select MM for millimeters or IN for inches.

Enter Service Mode

The Enter Service Mode feature allows you to complete service adjustments on the system.

Information

The User Interface allows you to view information about Die Type, Die Cycles, Punch Cycles, and Firmware

Die Type

The Die Type feature identifies the type of Die Set installed to the Stream Punch VFX.

Die Cycles

The Die Cycles feature lists the number of punch cycles completed by the die set that is presently installed in the machine.

Punch Cycles

The Punch Cycles feature lists the number of punch cycles completed by the Punch.

Firmware

The Firmware feature identifies the level of the firmware installed to the Stream Punch VFX.

Crease User Interface Screen Map

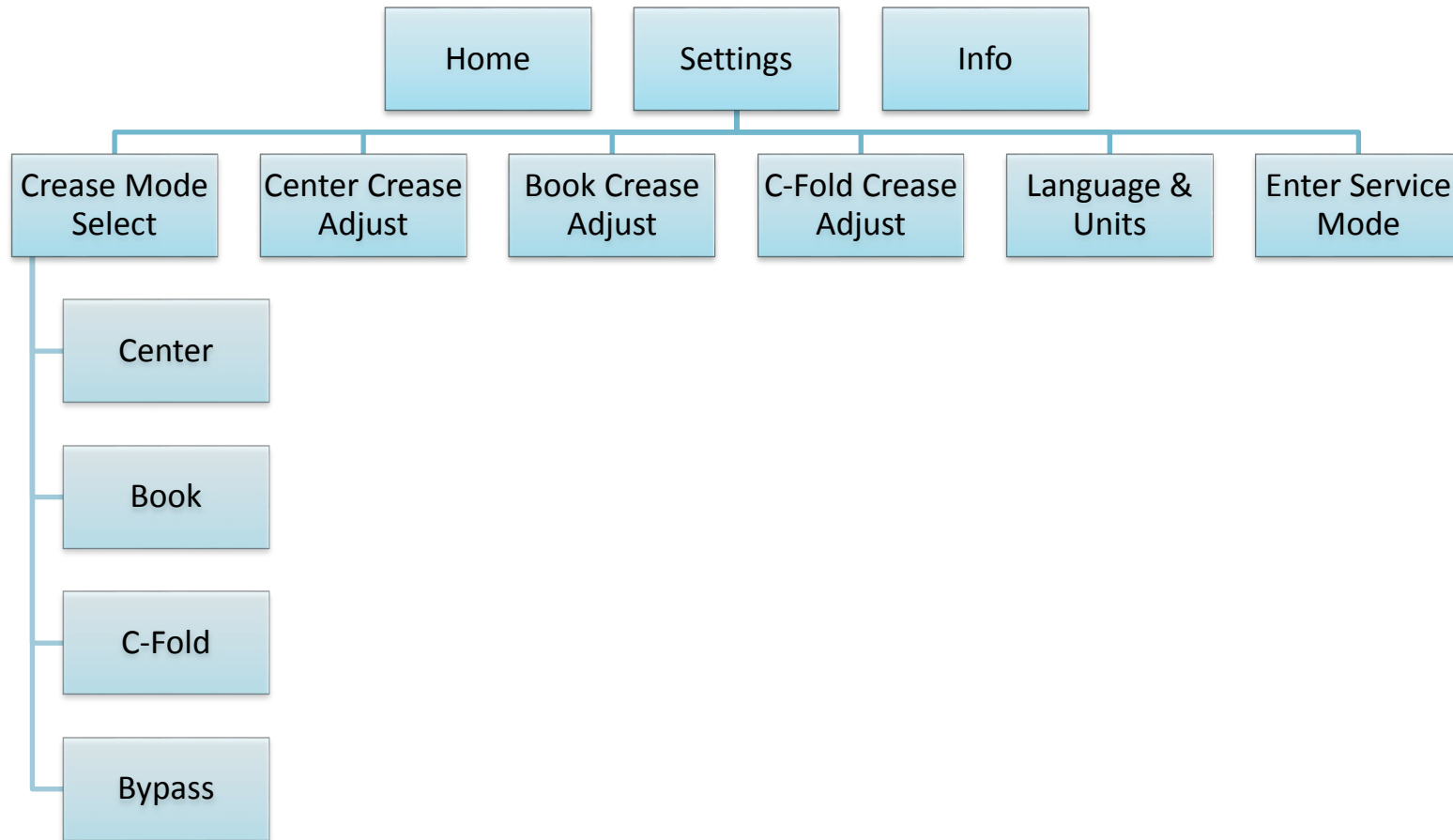

Crease Settings Procedure

Use the following procedures to change the settings on the User Interface:

- GP 6.1.12 CREASE MODE SELECT Procedure
- GP 6.1.13 CENTER CREASE ADJUST Procedure
- GP 6.1.14 BOOK CREASE ADJUST Procedure
- GP 6.1.15 C-FOLD CREASE ADJUST Procedure
- GP 6.1.16 LANGUAGE Procedure
- GP 6.1.17 UNITS Procedure

GP 6.1.12 CREASE MODE SELECT Procedure

The Crease Mode Select feature allows you to choose the desired function of the machine. Mode selection options will change depending on what type of die is currently installed.

The following options are offered:

- Center
- Book
- C-Fold
- Bypass

Click on the desired function and press the CHECK MARK button to confirm it. This will bring you to a new page that allows you to adjust the chosen crease type. See GP 6.1.13-6.1.15 to complete these adjustments.

GP 6.1.13 CENTER CREASE ADJUST Procedure

The following allows you to adjust the location of the center crease function.

1. From the Home screen, click on SETTINGS.
2. Select the CENTER CREASE ADJUST button.
3. Use the +/- buttons to move the crease location closer or further from the center of the sheet.
4. Click on the CHECK MARK button to save your changes.

GP 6.1.14 BOOK CREASE ADJUST Procedure

The following procedure allows you to adjust the locations of both creases to create a book crease.

1. From the Home screen, click on SETTINGS.
2. Select the BOOK CREASE ADJUST button.
3. Use the +/- to adjust the location of both creases.
 - Increasing the value of Y will move the front crease closer to the lead edge of the sheet.
 - Increasing the value of X will move the rear crease closer to the trail edge of the sheet.
 - Use the X=Y button to set the two creases at the same distance from the center of the sheet.
4. Click on the CHECK MARK button to confirm your changes.

GP 6.1.15 C-Fold CREASE ADJUST Procedure

The following procedure allows you to adjust the locations of both creases to create a C-Fold crease.

1. From the Home screen, click on SETTINGS.
2. Select the C-FOLD CREASE ADJUST button.
3. Use the +/- to adjust the location of both creases.
 - Increasing the value of Y will move the front crease closer to the lead edge of the sheet.
 - Increasing the value of Z will move the rear crease further from the trail edge of the sheet.
4. Click on the CHECK MARK button to confirm your changes.

GP 6.1.16 LANGUAGE Procedure

Do the following to select the Language mode.

1. From the home screen, click on SETTINGS.
2. Use the scroll bar to navigate to the second page. Click on LANGUAGE & UNITS.
3. Choose your desired language from the following list:
 - English
 - Espanol
 - Francais
 - Italiano
 - Deutsch

Once you have selected a language, press the CHECK MARK button. Then, click YES to save the setting.

GP 6.1.17 UNITS Procedure

Do the following to select the Units mode.

1. From the home screen, click on SETTINGS.
2. Use the scroll bar to navigate to the second page. Click on LANGUAGE & UNITS.
4. Choose your desired units from the following list:
 - Inches
 - Millimeters
5. Once you have selected a unit, press the CHECK MARK button. Then, click YES to save the setting.

Perforation Settings

Settings

Perf Mode Select

The Perf Mode feature allows you to choose the desired function of the machine. Mode selection options will change depending on what type of die is currently installed. The perforation die gives the options of a Center, Single, or Double perforation or for the machine to bypass the sheets.

Center Perf Adjust

The Center Perf Adjust feature allows you to adjust the location of the Center perforation with +/- buttons.

You can change the location of the perforation relative to the center of the sheet up to ± 12.0 mm.

Single Perf Adjust

The Single Perf Adjust feature allows you to adjust the location of a single perforation relative to the trail edge of the paper with +/- buttons.

You can change the location of the perforation from +9.0mm-228.0mm relative to the trail edge of the paper.

Double Perf Adjust

The Double Perf Adjust feature allows you to adjust the location of two perforations on the sheet relative to the trail edge of the paper with +/- buttons.

Language & Units

The Language feature allows you to select the language for the user interface. The language options are: English, Deutsch, Espanol, Francais, and Italiano.

The Units feature allows you to select the units displayed on the user interface. Select MM for millimeters or IN for inches.

Enter Service Mode

The Enter Service Mode feature allows you to complete service adjustments on the system.

Information

The User Interface allows you to view information about. Die Type, Die Cycles, Punch Cycles, and Firmware

Die Type

The Die Type feature identifies the type of Die Set installed to the Stream Punch VFX.

Die Cycles

The Die Cycles feature lists the number of punch cycles completed by the die set that is presently installed in the machine.

Punch Cycles

The Punch Cycles feature lists the number of punch cycles completed by the Punch.

Firmware

The Firmware feature identifies the level of the firmware installed to the Stream Punch VFX.

Perforation User Interface Screen Map

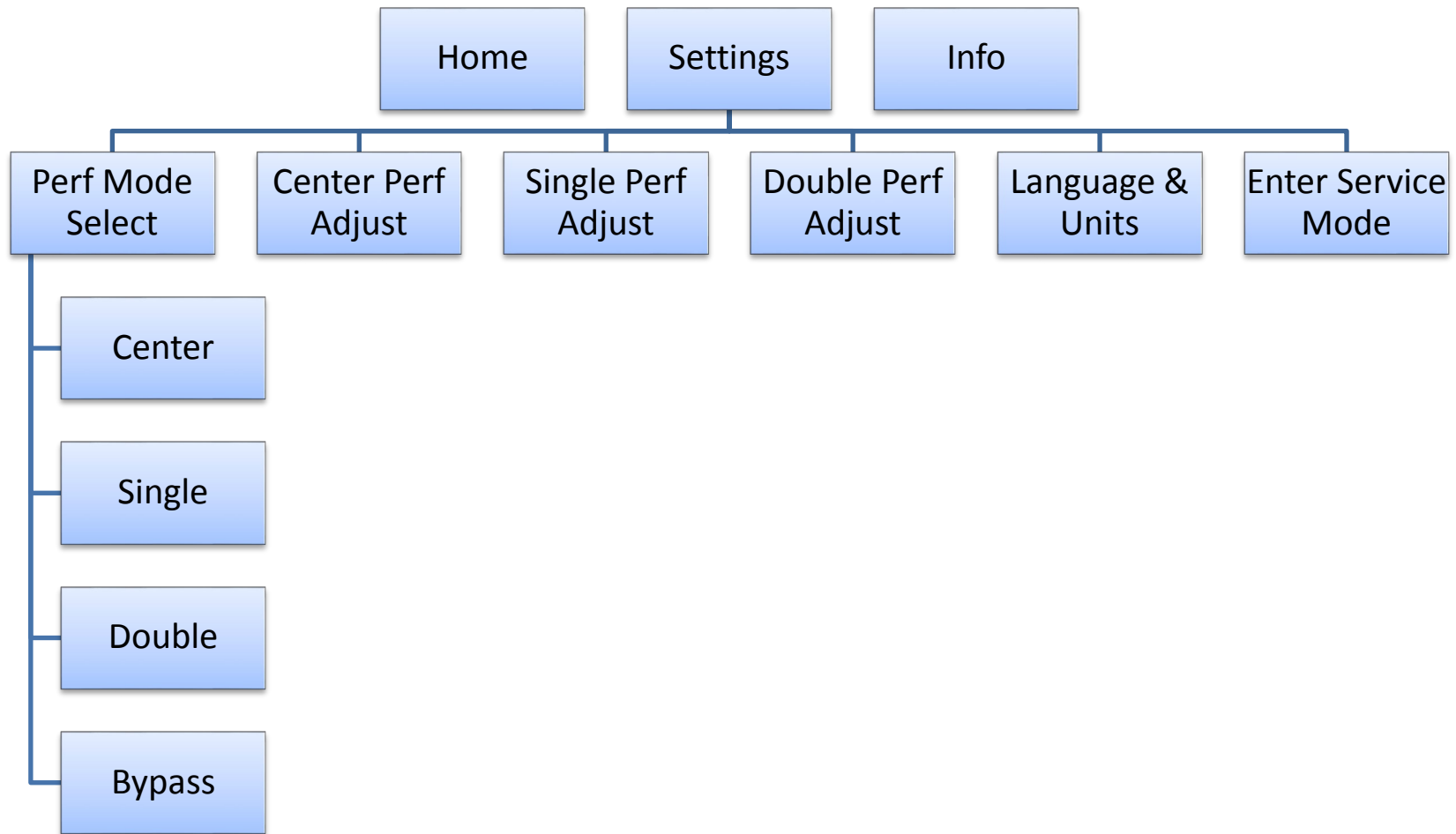

Perforation Settings Procedures

Use the following procedures to change the settings on the User Interface:

- GP 6.1.18 PERF MODE Procedure
- GP 6.1.19 CENTER PERF Procedure
- GP 6.1.20 SINGLE PERF Procedure
- GP 6.1.21 DOUBLE PERF Procedure
- GP 6.1.22 LANGUAGE Procedure
- GP 6.1.23 UNITS Procedure

GP 6.1.18 PERF MODE SELECT Procedure

The Perf Mode Select feature allows you to choose the desired function of the machine. Mode selection options will change depending on what type of die is currently installed.

The following options are offered:

- Center
- Single
- Double
- Bypass

Click on the desired function and press the CHECK MARK button to confirm it. This will bring you to a new page that allows you to adjust the chosen crease type. See GP 6.1.19-6.1.21 to complete these adjustments.

GP 6.1.19 CENTER PERF Procedure

Complete the following to change the perforation location for a Center Perf.

1. From the home screen, click on SETTINGS.
2. Select CENTER PERF ADJUST.
3. Use the +/- buttons to change the offset relative to the center of the sheet.
 - Increasing the value of X moves the perf further from the trail edge of the sheet.
 - Decreasing X moves the perf closer to the trail edge of the sheet.
4. Press the CHECK MARK button to save the new perforation value.

GP 6.1.20 SINGLE PERF Procedure

Complete the following to change the perforation location for a Single Perf.

1. From the home screen, click on SETTINGS.
2. Select SINGLE PERF ADJUST.
3. Use the +/- buttons to change the offset relative to the center of the sheet.
 - Increasing the value of X moves the perf further from the trail edge of the sheet.
 - Decreasing X moves the perf closer to the trail edge of the sheet.
4. Press the CHECK MARK button to save the new perforation value.

GP 6.1.21 DOUBLE PERF Procedure

The following procedure allows you to adjust the locations of both perforations on a double perf.

1. From the Home screen, click on SETTINGS.
2. Select the DOUBLE PERF ADJUST button.
3. Use the +/- to adjust the location of both perforations.
 - Increasing the value of Y will move the front perforation closer to the lead edge of the sheet.
 - Increasing the value of Z will move the rear perforation further from the trail edge of the sheet.
5. Click on the CHECK MARK button to confirm your changes.

GP 6.1.22 LANGUAGE Procedure

Do the following to select the Language mode.

1. From the home screen, click on SETTINGS.
2. Use the scroll bar to navigate to the second page. Click on LANGUAGE & UNITS.
3. Choose your desired language from the following list:
 - English
 - Espanol
 - Francais
 - Italiano
 - Deutsch

Once you have selected a language, press the CHECK MARK button. Then, click YES to save the setting.

GP 6.1.23 UNITS Procedure

Do the following to select the Units mode.

1. From the home screen, click on SETTINGS.
2. Use the scroll bar to navigate to the second page. Click on LANGUAGE & UNITS.
3. Choose your desired units from the following list:
 - Inches
 - Millimeters
4. Once you have selected a unit, press the CHECK MARK button. Then, click YES to save the setting.

Service User Interface

The Service User Interface allows you to:

- Set the Paper Size, Max Bypass sheet length and Run Mode.
- Check the operation of the Sensors, Solenoids, and the Motors.
- Run the Cycle Punch, Aligner Test, Exhaust fan test routines.
- Set the Skew Offsets and Align Offsets.
- View Die cycles and Machine log
- Upgrade Firmware

Sensors

The Sensors feature allows you to view the state of each of the 29 sensors.

- 0 means the sensor is open.
- 1 means the sensor is covered

Motors

The Motors feature allows you to test the operation of each of the 8 motors to the StreamPunch VFX.

Solenoids

The Solenoid feature allows you to test the operation of each of the 8 solenoids to the StreamPunch VFX.

Function Tests

The Function Tests feature allows you to run the Cycle Punch, Aligner Test, and Fan Test routines.

Click on the desired test you wish to run.

- The **Cycle Punch Test** starts the Punch Motor, waits for 2 seconds, the triggers the Punch at 1 punch per second for 5 cycles.
- The **Aligner Test** moves the home Aligner CW 10mm, back to home, CCW 10mm, then back to home. It repeats this cycle 5 times.
- The **Fan Test** starts the Exhaust Fan at the rear of the Punch.

Firmware/Log

The Firmware Update feature allows you to update the firmware for the Punch.

The LOG file download option will save the information about the last 50 punched sheets to a USB flash drive.

Setup Options

The Setup Options feature allows you to adjust the Run Mode, Paper Size, and DFA End Device setting.

The Run Mode feature allows you to select from the following:

- AUTO RUN
- AUTO CYCLE

The Paper Size feature allows you to select the desired paper size from the following:

- ANSI
- ISO

The DFA End Device feature allows you to select if the StreamPunch VFX is the end device in the train. If an eWire is to be used, set this value to NO.

Max Bypass

The Max Bypass feature allows you to set the maximum sheet length that will be bypassed through StreamPunch VFX. Setting the maximum sheet length high allows large banner sheets to be bypassed by the Punch. A high value for max bypass will cause paper jams to be detected more slowly, which could lead to more wasted paper.

Skew Offsets

The Skew Offsets feature allows you to setup the skew offsets to straighten and offset punch depth. The options are:

- Trail Edge
- Mid Punch L
- Mid Punch XL

Service Interface Screen Map

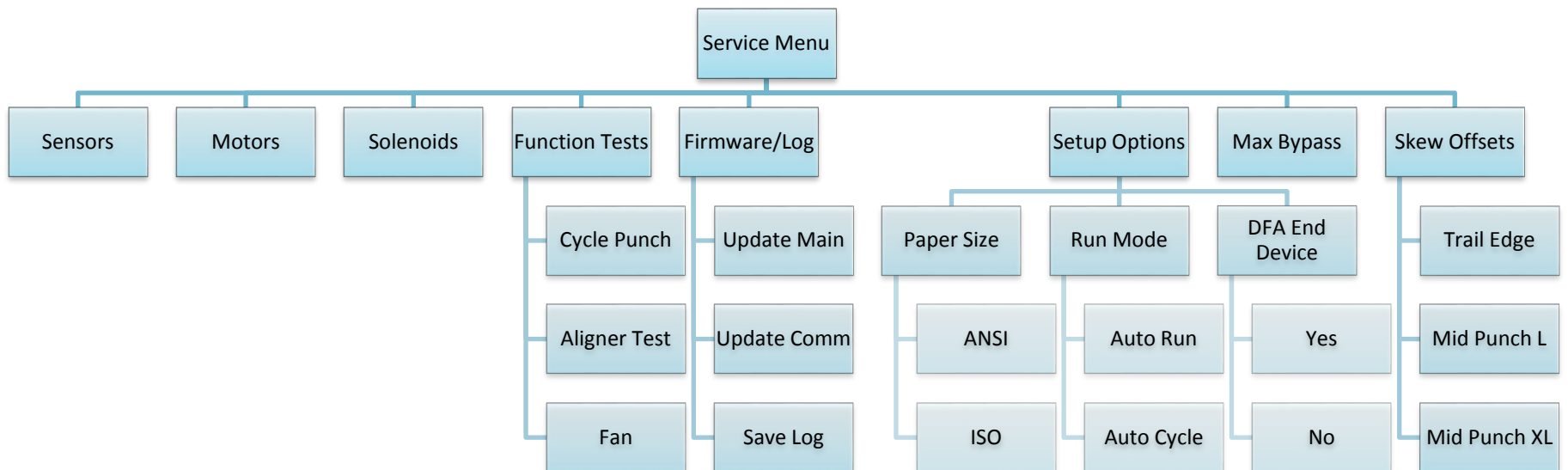

GP 6.2 Service User Interface Procedure

To enter the Service User Interface:

1. From the home screen, click on SETTINGS.
2. Use the scroll bar to navigate to the third page. Click on ENTER SERVICE MODE.
3. Type in the following password: **422**.
Then, press ENTER.

Note: If the previous password is not accepted, use **12345**.

The Service User Interface screen will appear.

Use the following procedures to use Service User Interface:

- GP 6.2.1 PAPER SIZE
- GP 6.2.2 MAX BYPASS
- GP 6.2.3 RUN MODE
- GP 6.2.4 DIE CYCLES
- GP 6.2.5 SENSORS
- GP 6.2.6 SOLENOIDS
- GP 6.2.7 MOTORS
- GP 6.2.8 FUNCTION TESTS (Cycle Punch, Aligner Test, Fan Test)
- GP 6.2.9 SKEW OFFSETS
- GP 6.2.10 ALIGN OFFSETS
- GP 6.2.11 LOG
- GP 6.2.12 FIRMWARE UPGRADE

GP 6.2.1 PAPER SIZE Setting

This setting is used for manufacturing set-up only.

GP 6.2.2 MAX BYPASS Setting

Complete the following to set the maximum bypass sheet length through the StreamPunch VFX.

1. Complete GP 6.2 to enter Service Mode.
2. Use the scroll bar to navigate to the second page. Click on the MAX BYPASS button.
3. Use the +/- buttons to adjust the Max Bypass value.
 - 1260mm is the Max Bypass setting
4. Press the CHECK MARK button. Then, click YES to save the value.

GP 6.2.3 RUN MODE Setting

When StreamPunch VFX is connected to a finisher this menu will show CONNECTED

When StreamPunch VFX is not connected to a finisher and the punch is powered ON, do the following to select the desired run mode.

1. Complete GP 6.2 to enter Service Mode.
2. Use the scroll bar to navigate to the second page. Click on the SETUP OPTIONS button.
3. The top right box on the screen indicates the Run Mode selection. Choose the desired Run Mode by clicking on it.
 - AUTO RUN – This feature is used for manufacturing set-up only.
 - AUTO CYCLE – Covering Sensor S25 will enable all components: all motors, all solenoids. It can be used to check the functioning of all motors and solenoids.
4. Press the CHECK MARK button. Then, click YES to save the settings.

GP 6.2.4 DIE CYCLES

Do the following to view the number of cycles the die set that is currently installed in the machine.

Refer to GP 6.1.9 to navigate to the die cycles information.

GP 6.2.5 SENSORS Check

A sensor can fail in two modes:

- **Failed in High state:** Machine thinks there is no sheet even when a sheet is present. In this mode, the LCD will always show "0" for that sensor, and will not go to "1" when a sheet is present.
- **Failed in Low state:** The converse of the above. "PAPER JAM...." message will be seen on LCD.

It is unlikely for a sensor to fail in a Low state. Therefore a bad sensor will most likely not give a "PAPER JAM..." message.

When there is "Paper Jam..." it is most likely because there is a sheet/piece of paper, or paper dust collecting over the sensor.

Procedure

Complete the following to check the status of any of the sensors.

The Sensors feature allows you to view the state of each of the 29 sensors to the StreamPunch VFX.

Cover each sensor to check if the sensor status changes from "0" to "1".

- 0 means the sensor is open.
- 1 means the sensor is covered.

Complete the following to check the sensors.

1. Complete GP 6.2 to enter Service Mode.
2. Click on the SENSORS button.
3. All 29 sensors are displayed with a status of 0 or 1.
 - Uncovered = 0
 - Covered = 1

NOTE: Door can be open to do this.

GP 6.2.6 SOLENOIDS Check

Do the following to check the sensors.

1. Complete GP 6.2 to enter Service Mode.
2. Click on the SOLENOIDS button.
3. To check the Solenoids:

NOTE: Door needs to be closed or Interlock Cheater inserted to do this.

- Press the specific solenoid button of the one you want to test.
- The selected solenoid will turn on temporarily.
- Press the button a second time to disengage the solenoid. If solenoid is left on for an extended period of time, it will turn off automatically to prevent over-heating.
- Repeat as needed to check the other Solenoids.
- If a Solenoid does not operate do GP 6.22 Solenoid Cleaning and Inspection.

GP 6.2.7 MOTORS Check

Do the following to test any of the Stepper Motors.

The Motors feature allows you to test the operation of most of the 8 stepper motors to the StreamPunch VFX. To check M5, See the Function Tests section of this manual GP 6.2.8.

Do the following to check the Motors.

1. Complete GP 6.2 to enter Service Mode.
2. Click on the MOTORS button.
3. To check the Stepper Motors:

NOTE: Door needs to be closed to do this.

- Click on the specific motor you would like to test.
- You should hear the motor running
(a low whine for Motors M1, M2, M6, M7, & M8)
(a soft whine for Motors M3, & M4),
- Press the motor button a second time to stop it.
- Repeat as needed to check the other Stepper Motors.

GP 6.2.8 FUNCTION TESTS (Cycle Punch, Aligner Test, Fan Test)

Do the following to test any of the Function Tests.

The Function Tests feature allows you to run the Cycle Punch, Aligner Test, and Fan Test routines.

Do the following to check the Motors and run the CYCLE PUNCH test:

1. Complete GP 6.2 to enter Service Mode.
2. Click on the FUNCTION TESTS button.
 - The CYCLE PUNCH Test starts the Punch Motor, waits for 2 seconds, then triggers the Punch at 1 punch per second for 5 cycles.
 - After the test is complete it stops automatically, you may return to Previous Menu or Exit Service Mode.
3. To check the alignment, click on the ALIGNER TEST button.
 - The Aligner Test moves the home Aligner CW 10mm, back to home, CCW 10mm, then back to home. It repeats this cycle 5 times.
 - After the test is complete it stops automatically, you may return to Previous Menu or Exit Service Mode.
4. To check the exhaust fans, click on the FAN button.
 - The Fan Test turns the Exhaust Fan on and off.

GP 6.2.9 SKEW OFFSETS Adjustment

Do the following to setup the skew offsets to straighten and offset punch depth.

Do the following to setup the skew offsets.

1. Complete GP 6.2 to enter Service Mode.
2. Use the scroll bar to navigate to the second page of the menu.
3. Click on the SKEW OFFSETS button.
4. Click on one the following skew offset that you would like to adjust:
 - Trail Edge
 - Mid Punch L
(for LTR Short Edge and A4 Short edge Double punch)
 - Mid Punch XL
(for 11 x 17 Short Edge and A3 Short Edge Double punch)
 - If you want to change another Skew Offset, press the down arrow to scroll through the Skew Offset options, then repeat the this entire step for the other Skew Offset option.
5. Use the +/- buttons to change the Rear and Front offsets
6. To check Skew, fold the sheet in half.
 - The holes should line up.

Bottom most hole is at correct Backgace depth, but the top hole is too far from the edge of the paper.

BG Rear ‘-’ Increment value until holes are in the correct position.

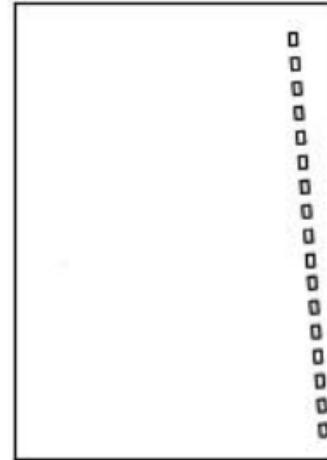

Top most hole is at correct Backgace depth, but the bottom hole is too far from the edge of the paper.

BG Front ‘-’ Increment value until holes are in the correct position.

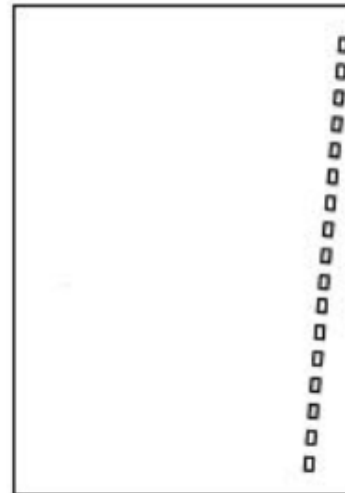

The bottom hole is in the correct position, but the top hole is too close to the edge of the paper.

BG REAR '+' Select 1 1, 2, 3...etc. until the holes are parallel to the edge.

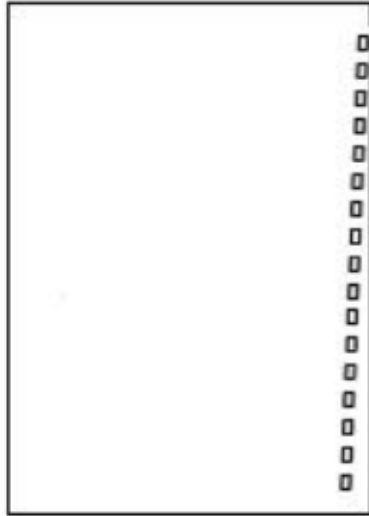

The top hole is in the correct position, but the bottom hole is too close to the edge of the paper.

BG FRONT '+' Select 1 1, 2, 3...etc. until the holes are parallel to the edge.

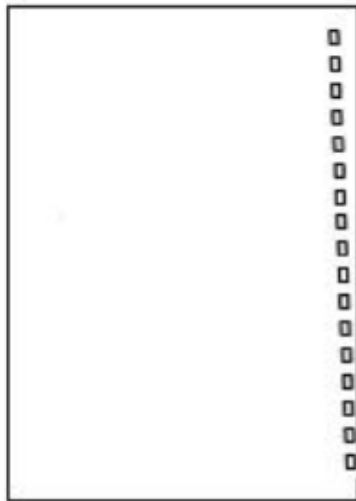

For Double punch skew offsets, the same principle applies. Examples shown below:

BG DP L REAR '+' Select 1 1, 2, 3...etc. until the holes are parallel to the edge.

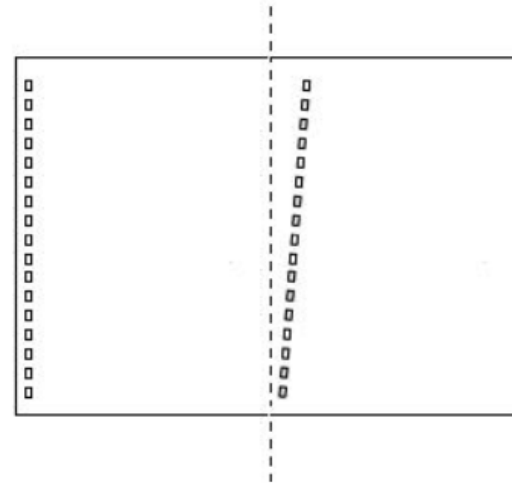

BG DP L FRONT '+' Select 1 1, 2, 3...etc. until the holes are parallel to the edge.

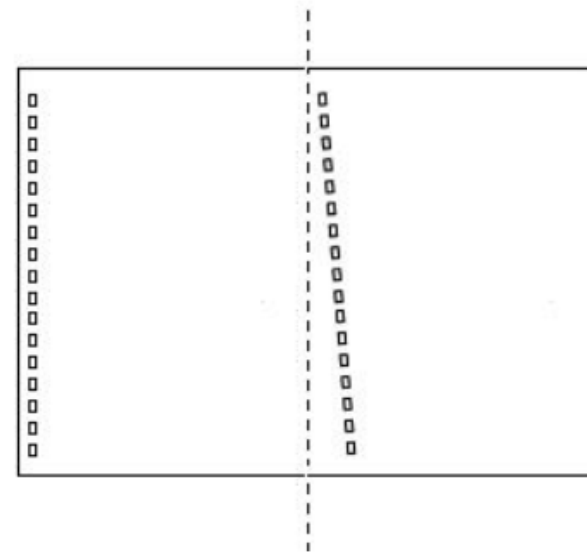

GP 6.2.10 ALIGN OFFSETS Adjustment

Do the following to setup the align offsets.

Procedure

Do the following to make adjustments to the Align Offsets. The Align Offsets is same as the Alignment Offset in the User setting, except:

- The User Alignment setting adjusts the Alignment position of all sheets (regardless of size) that are processed by StreamPunch VFX.
- The ALIGN OFFSETS described here are performed to individual sensors. Therefore adjusting a sensor's Align Offsets will only impact the sheet sizes using that particular sensor.

The below table shows the sensor for each sheet size:

Sensor	Sheet sizes
S11	none
S12	A4-LEF, A4 tab, A3-SEF
S13	LTR-LEF, LTR tab, 11x17-SEF
S14	none
S15	1/2LTR-LEF, 1/2LTR tab, LTR-SEF, Legal SEF A5-LEF, A5 tab, A4-SEF

GP 6.2.11 LOG

The LOG file download option will store the following data for download via USB.

Debug data for last 50 sheets.

- Sheet size measured i.e S,M,L,LG or XL
- Skew sensors used
- First deskew steps
- Alignment sensor used
- Second deskew steps.
- Align fail safe stop (if occurred)

Sensor timings for last 10 sheets.

- Punch mode, time from LE S1 to LE S8
- Punch mode, time from LE S8 to LE at S25

Other data

- Punch cycle count
- Bypass cycle count
- Individual die type counts
- Record the last 20 Jam codes in a column format

Do the following steps to capture the LOG files.

1. Remove (2) M4 screws and the USB/Debug/E-wire port cover.
2. Insert the USB flash drive.
3. Complete GP 6.2 to enter Service Mode.
4. Use the scroll bar to navigate to the second page of the menu.
5. Click on the FIRMWARE/LOG button.
6. To capture the LOG files, click on the SAVE LOG button.

GP 6.2.12 FIRMWARE UPGRADE Procedure

Do the following to upgrade the firmware.

1. Remove (2) M4 screws and the USB port cover.
2. Save the firmware file you want to upload to the USB flash drive provided.
IMPORTANT NOTE: Only one Main and one Comm file should be present in the USB flash drive.
3. Complete GP 6.2 to enter Service Mode.
4. Use the scroll bar to navigate to the second page of the menu.
5. Click on the FIRMWARE/LOG button.
6. Insert the USB Flash drive with the firmware file you want to upload.
Note: this step can be done at any time before you press the Enter button for Main or Comm firmware upload (in Step 7).
7. There are two options for upgrading the firmware. Click on the one you would like to upgrade.
 - UPDATE MAIN: This updates the control board and the Main firmware.
 - UPDATE COMM: This updates the communication board.NOTE: If uploading both, do MAIN first.
8. Remove the USB flash drive with the firmware file you uploaded.
9. Install the Cover for USB port and tighten the Screws (2).
10. Switch off the machine. Wait 10 seconds, and then switch the machine back on again.

GP 6.3 Undock the Punch (Moving the punch to Service position)

Use this procedure to move the punch to Service position

1. Unplug the AC power cord.
2. Unplug the Communications cable and DFA Cables
3. Follow the downstream device instructions for undocking the downstream device.
4. Pull the lever on the underside of the machine to release the docking mechanism.
5. Pull the StreamPunch VFX away from the upstream device.

GP 6.4 Dock the punch

1. Position the punch in position near the upstream device.
2. Check that the StreamPunch VFX paper path height is aligned with the upstream device paper path height. If adjustment is needed, adjust the height of the Punch using the casters.
3. Slide the docking clamps on the StreamPunch VFX into the docking pegs on the upstream device. Move the punch towards the upstream device until the clamps snap into place.
4. Check the horizontal alignment of the Punch. If adjustment is needed, refer to the adjustment instructions for the upstream device docking assembly.
5. Connect the Communications cable and DFA cables.
6. Connect the AC power cord.
7. Run a small test job in both Punch and Bypass mode to ensure the machine is working properly.

GP 6.5 Operational Inspection

Do the following on every service call to make sure the system is operating properly.

1. Make sure the punch operates smoothly and produces the desired holes in the customer's paper.
2. Refer to section 3.13 *Punch Specifications*.

GP 6.6 Internal Inspection

Do the following whenever the cover has been removed for corrective maintenance,

1. Visually inspect for defects and problems such as damaged components, loose screws or nuts, abraded wire insulation, loose terminals, etc.
2. Correct any problems before returning the machine to service.

GP 6.7 Die Set Service

The Die Set assembly is not serviceable other than inspection and periodic lubrication.

For the Perforation Die only, the backing plate assembly can be replaced when it is worn.

If a Die Set is at its end of life, it will tend to cause paper jam due to hanging chips. This is a result of die plate wear, and not pin wear, which cannot be corrected. When this occurs, the Die Set should be replaced with a new one.

GP 6.7.1 Die Set Life Expectancy

The StreamPunch VFX Die Sets have a minimum life expectancy of 750K cycles (sheets of paper punched, when punching 75 gsm paper). With periodic lubrication and optimum paper types, life can exceed this number.

Some dies have an HD version which will have an expected life greater than that of a standard die.

Use the Die Cycles feature on the User Interface to view the number of cycles on the Die Set.

Variables that affect life expectancy:

- Failure to follow the lubrication schedule or using the incorrect lubricant
- Variety and types of paper being punched
- Cover stocks being punched
- Length of the average job
- Other environmental conditions

GP 6.7.2 Die Set Components

Serviceable Components

- Punch pins [1]
- Felt pad (on some Die Sets) [2]

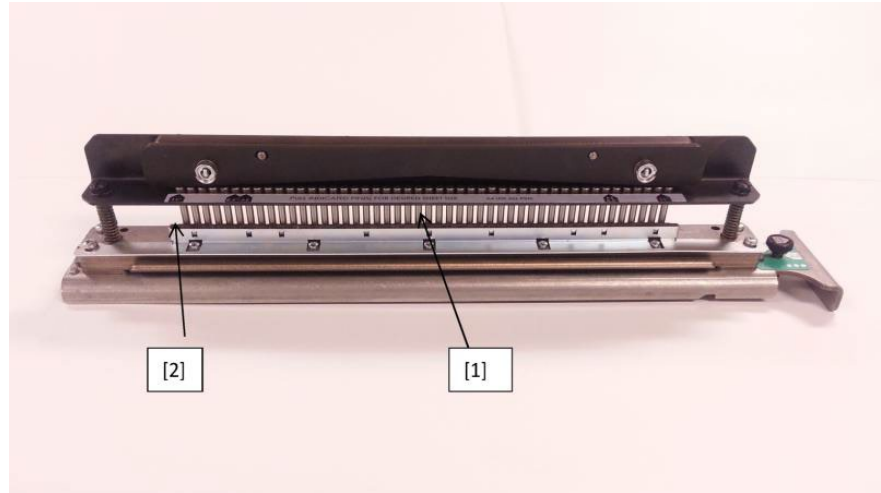

GP 6.7.3 Die Set Lubrication

Periodic lubrication extends the life of the Die Sets. This can be done by the user or the service technician.

Maintenance Schedule

Lubricate and inspect Die Set pins every 100K cycles.

Procedure

1. Inspect the punch pins for signs of wear or mis-alignment. Periodic lubrication extends the life of the Die Sets.
2. The customer or operator can perform this maintenance between technician inspections.



Inspect Punch Pins

To lubricate Die Set pins that do not have felt pads:

1. Depress the Die Set so that the pins protrude from the bottom plate.
2. Apply a drop of high quality machine oil to the end of each pin.
3. Wipe clean, leaving a light coat of oil on them.
4. Oil from the die may blemish the first few punched sheets after oil has been applied. Run test punched copies until clean copies can be made.

To lubricate Die Set pins that have felt pads:

1. Lubricate with a high quality machine oil.
2. Apply oil lightly along the length of the pad [1], but do not over saturate.
3. Do not use spray lubricants because they tend to dry up quickly and leave a sticky residue.
4. Oil from the die may blemish the first few punched sheets after oil has been applied. Run test punched copies until clean copies can be made.

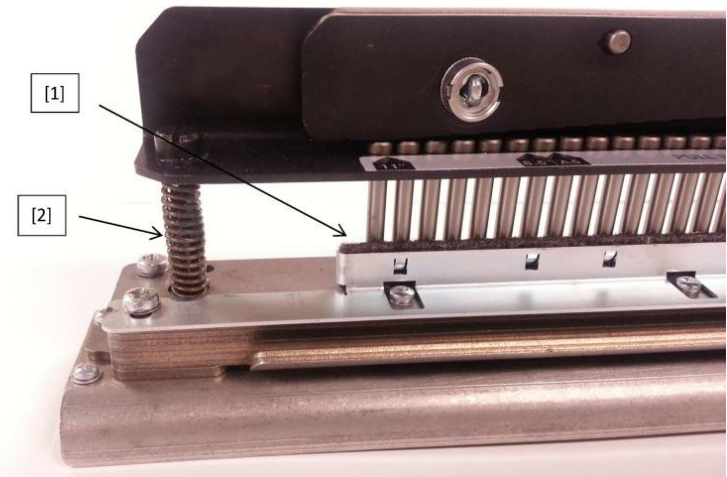

Die Set Lubrication Points

Die Set Inspection

1. Set the Die Set on a table and press the top plate straight down at both ends at the same time and look for a smooth operation. The top plate and pins should retract fully when you release.

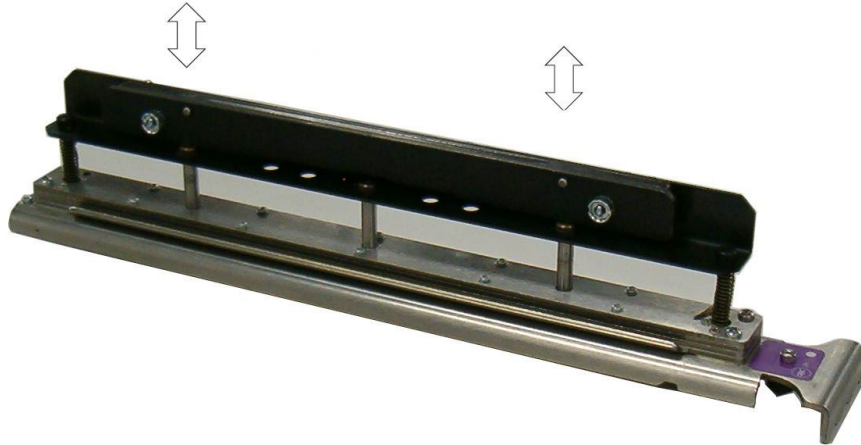

Check For Free Movement

2. Reinstall the Die Set into the punch and run several sheets of the customer's paper through the punch. Inspect the holes.
 - Holes should be clean and even with no tearing or frayed edges.
 - Holes should be punched completely, leaving no chip attached.
 - Holes should be straight (no skew) and evenly spaced from the edge of the paper and aligned. (See GP 6.2.9, SKEW OFFSETS).

GP 6.7.4 Die Set Shoulder Bolts

Do the following to inspect and lubricate the Die Set Shoulder Bolts every 200k Die cycles.

1. Lubricate with high quality Teflon-based grease.
2. Apply grease to Shoulder Bolts and Springs [2].
3. Wipe up any excess grease.

GP 6.8 External Cleaning

Do the following to clean the exterior of the StreamPunch VFX.

1. Clean the exterior covers with a soft cloth moistened with mild detergent and warm water.

Do not use chemical cleaners or solvents as these may have a harmful effect. Use detergent sparingly to avoid contact with electrical components.



Warning: Make sure you disconnect the StreamPunch VFX from its power source before cleaning. Failure to observe this warning could result in death or serious Injury.

GP 6.9 Internal Cleaning

Do the following to clean the interior of the StreamPunch VFX.

1. Occasionally remove the covers and remove paper dust and chips. Paper dust can accumulate throughout the punch including around the motor and other electrical components.

Use a vacuum cleaner if possible. A small paintbrush can also be used but extreme care should be used around electrical components.

2. Clean non-electrical components with alcohol, an approved cleaner, or a soft cloth moistened with mild detergent and warm water.
3. Clean the Rollers with alcohol.



Warning: Make sure you disconnect the StreamPunch VFX from its power source before cleaning. Failure to observe this warning could result in death or serious Injury.

GP 6.10 Base Cleaning

Chips and paper dust falls to the bottom of the punch. Clean every service call.

1. Clean with a vacuum cleaner each time the machine is serviced.
2. The customer can also do this between the technician's visits.

GP 6.11 Chip Bin Cleaning

Do the following on every service call to clean the Chip Tray.

1. Remove the Chip Bin and empty it.
2. Vacuum out paper chips and dust from the Chip Bin tray, especially at the holes on the sides of the Chip Tray.



GP 6.12 Die Guide Cleaning

Do the following to clean the Die Guide every 500K cycles.

1. Remove the Die Set and clean the guide [1] with a vacuum cleaner.

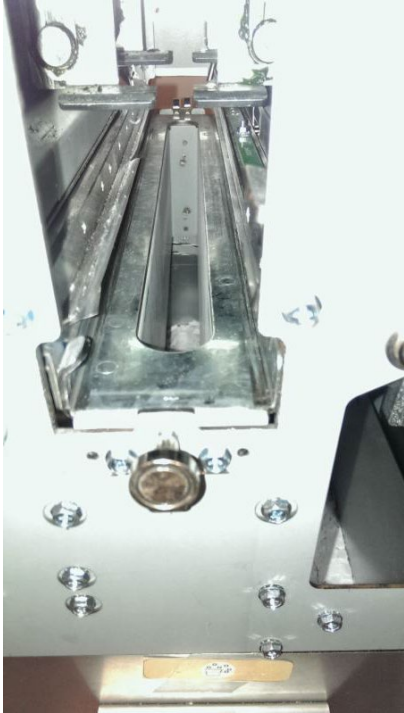

GP 6.13 Door Latch Inspection

Inspect the Door Latch every 1000K cycles.

The door latch must hold the door closed and ensure that the switch activation tab is depressing the door switch [1]. The switch tab [2] should press the switch button just so that it is close to bottom.

1. Ensure latch holds door closed.
2. Ensure switch is activated when the door is closed.
3. To adjust the door latch, see ADJ 1.1

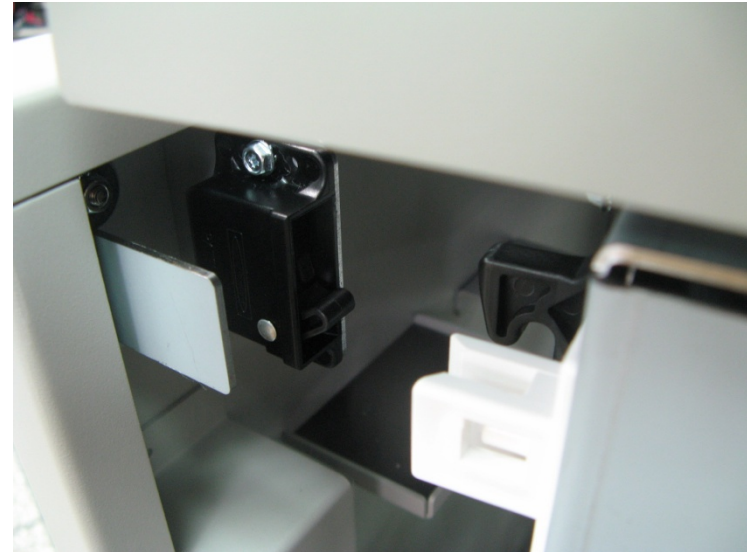

GP 6.14 Idler Roller and Idler Springs Inspection

Idler rollers press against the drive rollers and move the paper through the bypass [1] or the punch [2].

Maintenance Schedule

Inspect and clean every 1000K cycles.

Procedure

1. For the Idler Rollers in the following nips, inspect the rollers for wear, debris, toner marks, unevenness, and dents.

N1	N9
N2	N10
N3	N11
N4	N12
N5	N13
N8	N14

2. Inspect Springs (2) for each Idler Roller, and make sure they are correctly hooked.

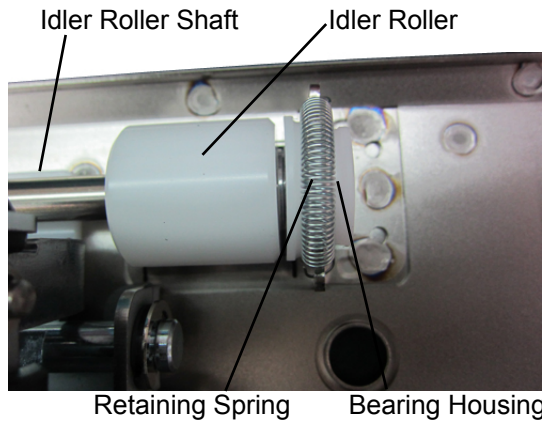

3. Inspect the Bearing Housing. The Bearing Housing should slide freely in the Bearing Forks.

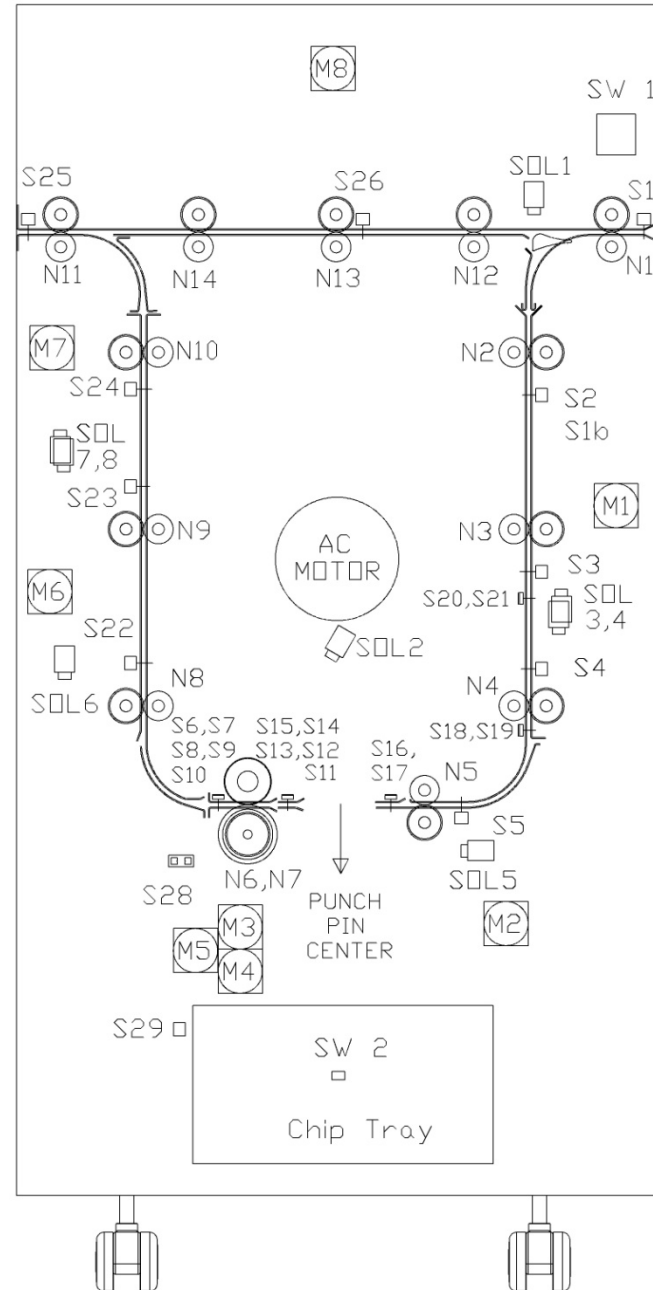

GP 6.14.1 Idler Roller Cleaning

Use this procedure to clean the Idler Rollers in these assemblies:

- Entrance Idler Panel.
- Acceleration Roller Idler Assy.
- Exit Idler Panel.
- Bypass Idler Assembly

Maintenance Schedule

Inspect and clean every 1000K cycles.

Procedure

1. Do ARP 2.4 *Idler Roller Replacement* to remove the Idler Roller.

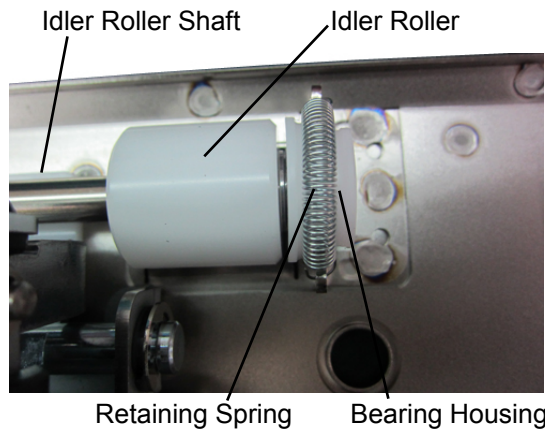

2. Clean the Idler Rollers with a soft cloth and alcohol.



3. Inspect rollers for wear patterns or groves. The roller surface should be smooth.
4. Ensure the rollers turn freely on the shaft and that the idler roller shaft "floats" freely in the bushing forks.
5. Do ARP 2.4 *Idler Roller Replacement* to install the Idler Roller.

GP 6.14.2 Steering Idler Roller and Springs Inspection and Cleaning

Use the procedure to clean and inspect these Steering Idler Rollers and Springs.

- N6
- N7

Maintenance Schedule

Inspect and clean every 1000K cycles.

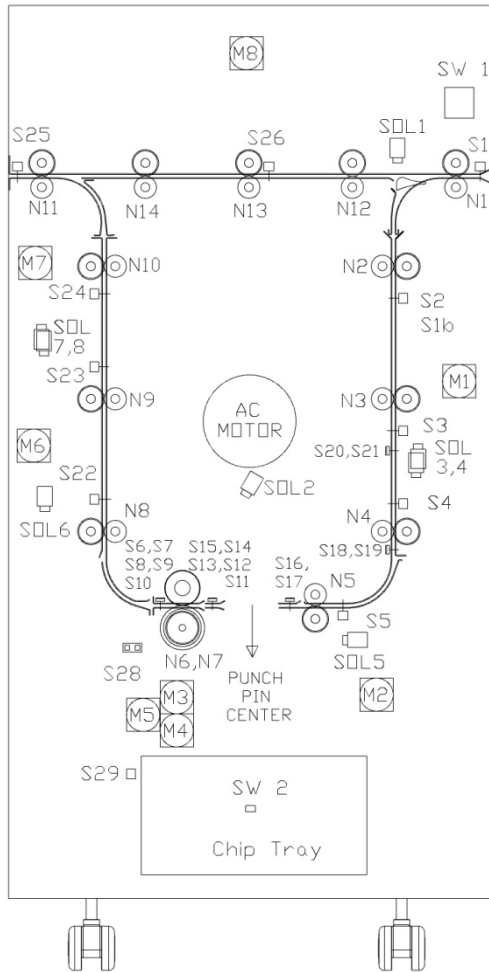

Procedure

To clean non-removable idler rollers:

1. Do ARP 3.1.1 Punch Module Removal.
2. Clean the Steering Idler Rollers with a soft cloth and alcohol.

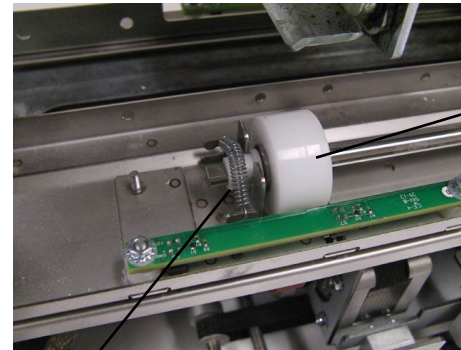

Steering Idler Roller

Spring

3. The roller surfaces should be free of debris, toner deposits, wear, unevenness, and dents.
4. Inspect the Steering Idler Springs. The Springs should be hooked securely and should be wrapped around the Bushing.
5. Do ARP 3.1.2 Punch Module Installation.

GP 6.15 Drive Roller and Steering Drive Roller Inspection and Cleaning

Do this procedure to inspect and clean the Drive Rollers and Steering Drive Rollers.

Maintenance Schedule

Inspect and clean every 1000K cycles.

Procedure

Some drive rollers are not easily accessible. Those that are [1], should be inspected and cleaned when the idler rollers are removed.

Where practical, make sure the rollers are clean. Clean with a soft cloth and alcohol.

See also, GP 6.14.1 *Idler Roller Cleaning*

It is recommended to clean the Drive Rollers with the Punch Module removed, because with the Punch Module removed it is easy to access all Drive Rollers.

1. Do ARP 3.1.1# Punch Module Removal.
2. Clean all Drive Rollers N1 – N16 with a clean cloth and alcohol.
3. The Drive Roller should be free of toner deposits, wear marks, scuff marks, dents, etc.
4. Use the above procedure to clean the Steering Drive Rollers

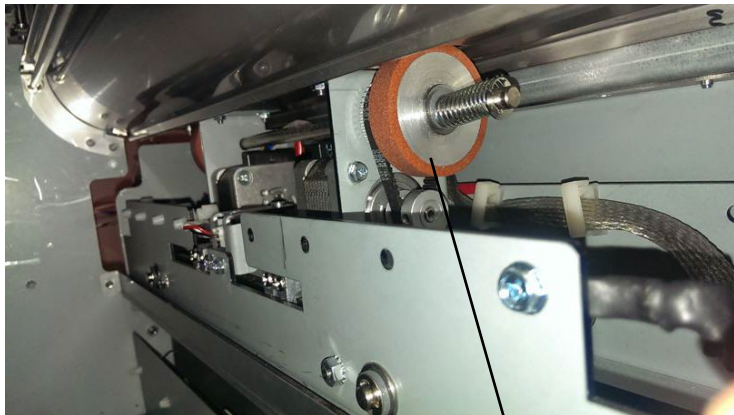

Steering Drive Rollers

5. Do ARP 3.1.2# Punch Module Installation.

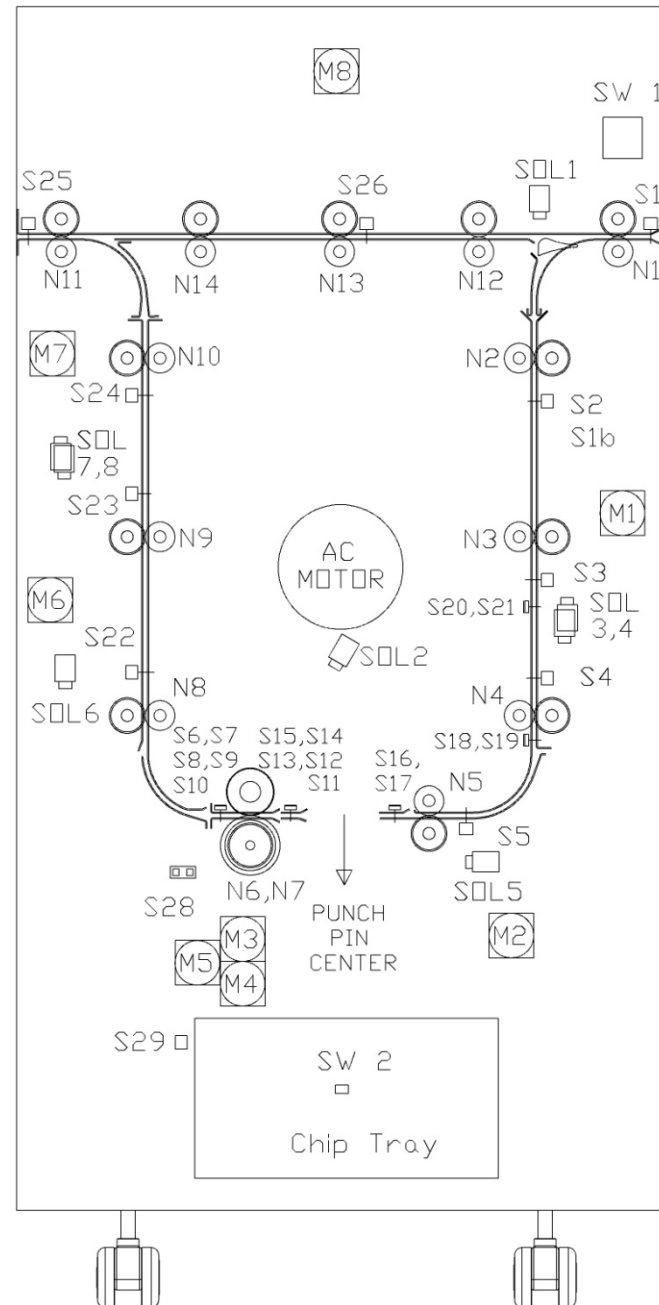

GP 6.16 Panel Latch Inspection

Magnetic latches on the Entrance and Exit Idler Panels, and the Upper Bypass Idler Assembly hold the Idler Panels in place, which in turn keep even pressure on the idler rollers.

The latch for the Acceleration Idler Panel ensures the Acceleration Panel remains firmly closed to keep even pressure on the Acceleration Idler Roller.

Maintenance Schedule

Inspect every 1,000K cycles.

Entrance Idler Panel Latch, Exit Idler Panel Latch, Upper Bypass Panel Latch Inspection

To inspect these three latches follow the procedure below:

- Entrance Idler Panel Latch
- Exit Idler Panel Latch
- Upper Bypass Panel Latch

1. Open the Front door.
2. When the idler panel is latched, the idler panel spacers ((2) spacers for each Idler assembly) should contact the drive panels completely. There should not be any movement in the idler assembly (toward or away from the drive panel).



3. When the idler panel is opened and closed, you should be able to see the Idler springs extend, which will ensure proper idler roller pressure.

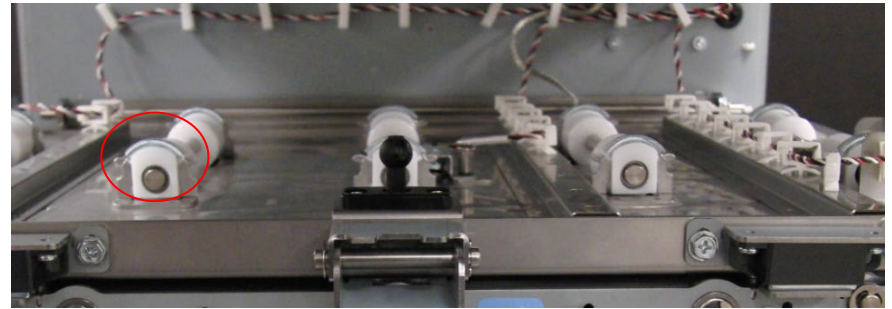

4. To adjust the Idler Panel magnetic Latches, do ADJ 1.7 Idler Panel Magnetic Latches Adjustment.

Acceleration Idler Latch Inspection

To inspect the Acceleration Idler latch follow the below procedure:

1. Open the Front door.
2. Undock StreamPunch VFX.
3. When the Acceleration panel latch is fully engaged, the tabs in the Idler panel should contact the drive panel. Inspect this for the latches in the front side and rear side.

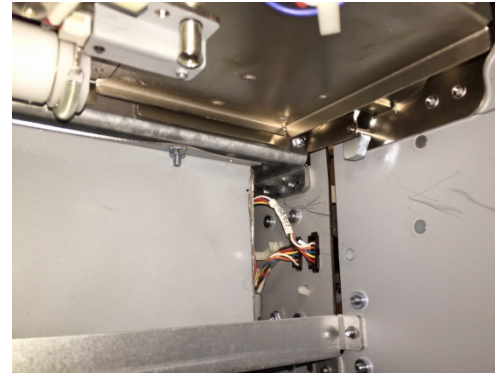
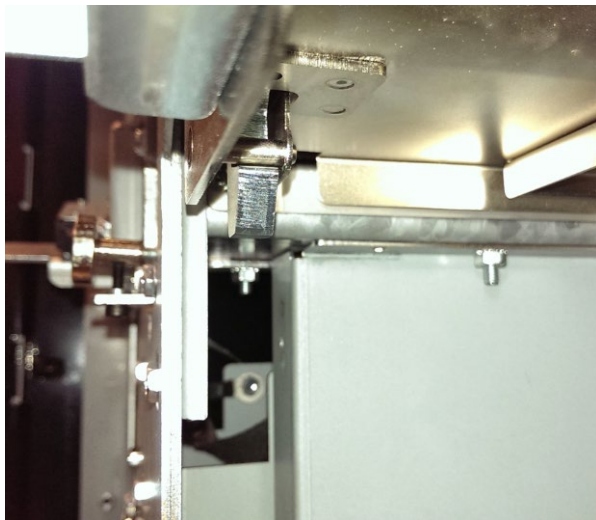
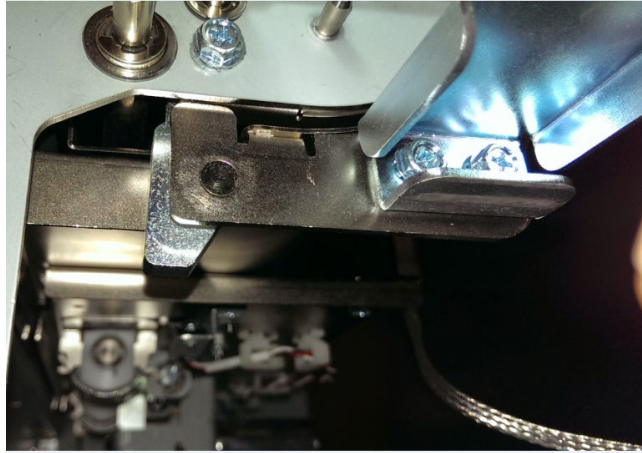

4. Do ARP 3.1.1 Punch Module Removal to remove the Punch Module.
5. Inspect the Acceleration Idler Panel latch assembly (front and rear side). There should be two springs between the latch mechanism and the Entrance Drive panel.



Acceleration panel latch springs

6. If the springs are damaged, do ARP 2.17 *Accel Idler Panel Rear Latch Assembly Replacement* or ARP 2.17 *Accel Idler Panel Front Latch Assembly Replacement*.

7. When the idler panel is opened and closed, you should be able to see the Idler springs extend, which will ensure proper idler roller pressure.



8. To adjust the Acceleration Idler Panel Latch, do ADJ 1.8 Entrance Drive Panel Position Adjustment.

GP 6.17 Optical Sensor Cleaning

Do the following call to inspect and clean the Optical Sensors.

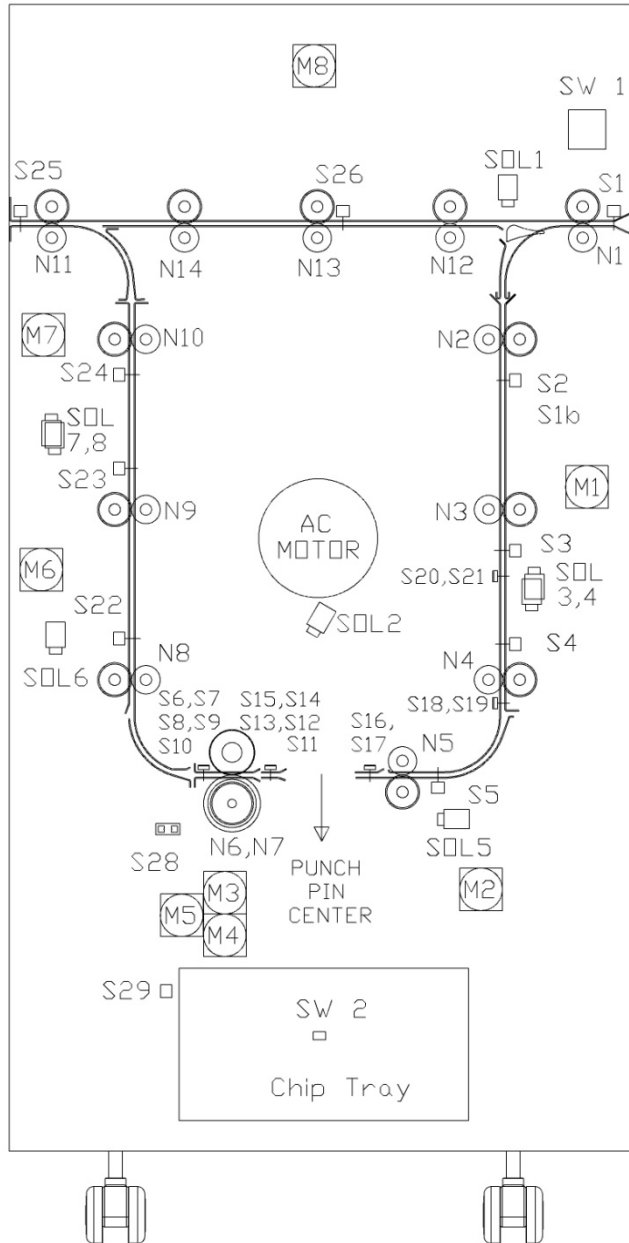

Maintenance Schedule

Inspect and clean every 500K cycles.

Procedure

Inspect and clean per the maintenance schedule or as needed.

Supplies Needed

Canned air or Clean cloth and alcohol

1. Use canned air to blow the debris off each sensor.

The following illustration shows examples of the sensors.

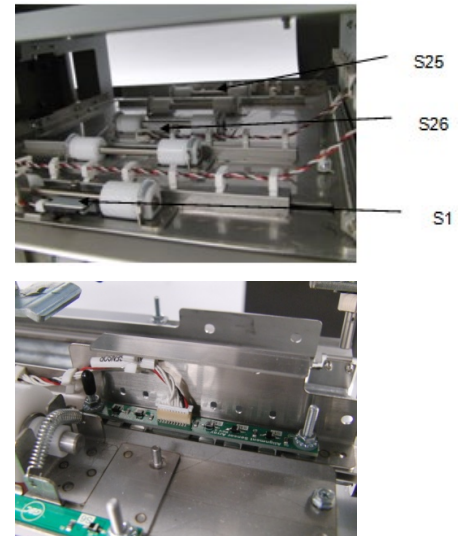

For sensor locations, refer to:

- PL 3.1
- PL 3.2
- PL 3.3
- PL 3.4
- PL 3.5
- PL 4.2
- PL 4.3
- PL 4.4
- PL 4.9

GP 6.18 Bypass Paper Path Inspection and Cleaning

Do the following to inspect and clean the Bypass Paper Path every 1000K cycles.

1. Inspect the Bypass panel, rollers, and entrance guide for wear, damage, and obstructions.
2. Inspect the rollers for wear patterns or groves. The surface should be rough and even. Make sure the rollers are clean. Clean rollers with a soft cloth and alcohol.

See also **Error! Reference source not found. Error! Reference source not found.** and **Error! Reference source not found. Error! Reference source not found.**

3. Raise the panel and ensure the magnet holds it in open [4]. Inspect the path for obstructions. Clean as needed.
4. Close the panel and check that it is flat and that paper will pass under it.
5. Ensure the bypass diverter moves freely and returns to the bypass position.

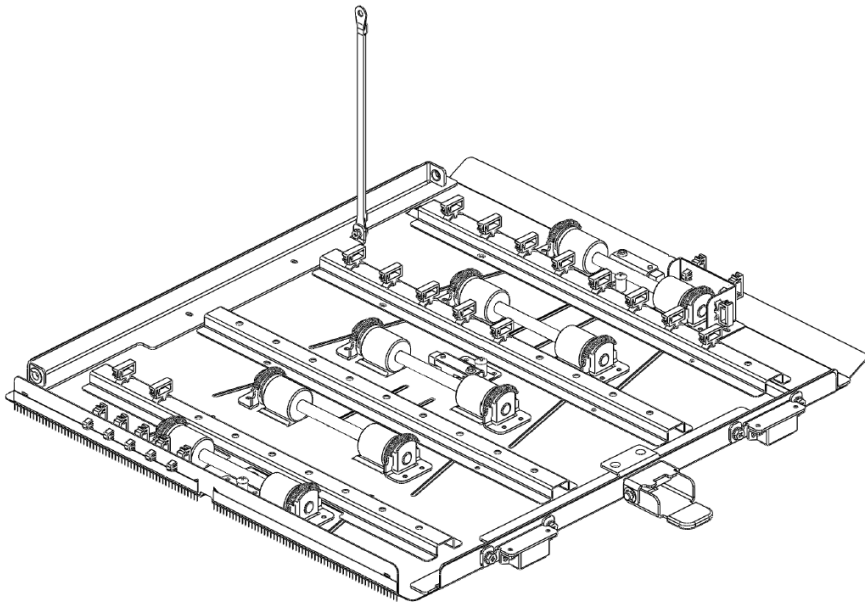

GP 6.19 Punch Paper Path Inspection and Cleaning

Do the following to inspect and clean the Punch Paper Path every 1000K cycles.

1. Inspect the entire paper path through the punch. Look for wear, damage, and obstructions.
2. Inspect the rollers for wear patterns or groves.
3. Open the Entrance Idler Panel, Acceleration Roller Idler, and Exit Idler Panel and make sure there are no obstructions.
4. Confirm that the Entrance Idler Panel Latch, Acceleration Roller Idler Latch, and Exit Idler Panel Latch hold the panels tightly in place.
If the latch is bent or damaged, replace the Entrance Idler Panel (ARP 2.3), Acceleration Roller Idler Assembly (ARP 2.5), or the Exit Idler Panel (ARP 2.9).
5. Clean as needed.

GP 6.20 Punch Drive Cam Lubrication

Do the following to lubricate the Punch Drive Cam.

Maintenance Schedule

Lubricate every 5000K cycles with Teflon grease.

Procedure

1. Do ARP 1.6 Rear Cover Replacement to remove the Rear Cover.
2. Do ARP 3.1.1 Punch Module Replacement to remove the Punch Module.
3. Clean the old grease from the cams and then apply a light coat of high quality grease (not oil).

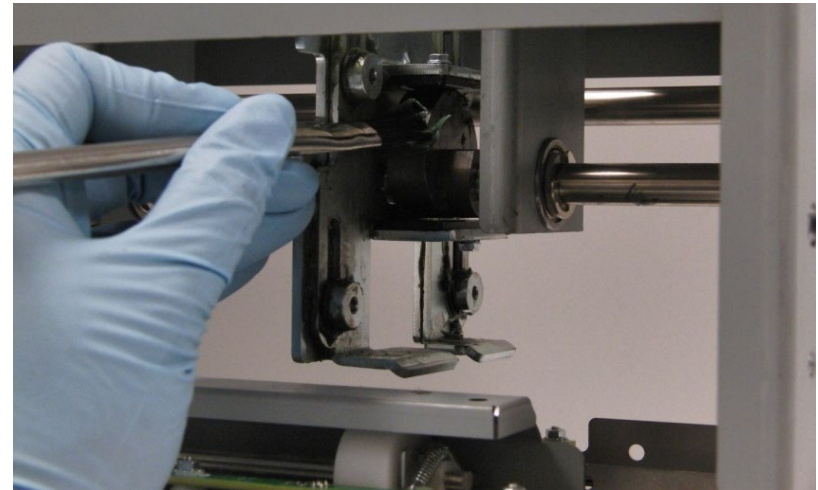
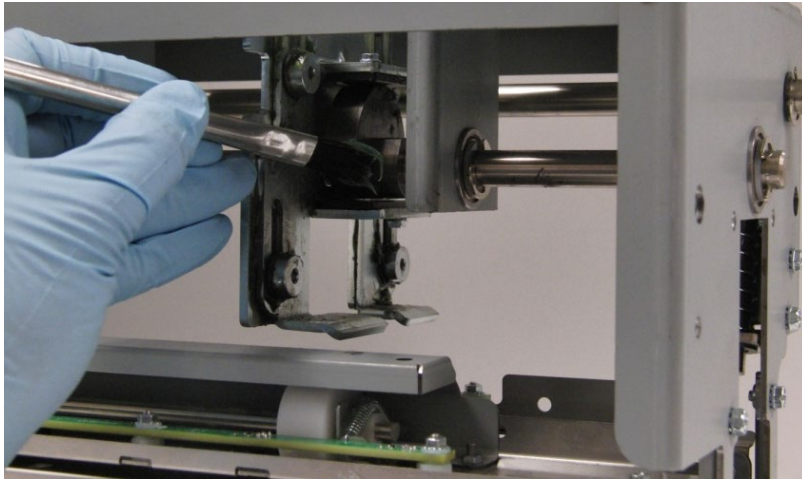

4. Do ARP 3.1.2 Punch Module Replacement to install the Punch Module.
5. Do ARP 1.6 Rear Cover Replacement to install the Rear Cover.

GP 6.21 Timing Belt Inspection

There are 11 belts used in the StreamPunch VFX.

Assembly	# of Belts
Punch Module	1 belt
Steering Module	1 belt
Drive Panel Steering Sub Assembly	2 belts
Frame	8 belts

Five of the belts at the rear of the Frame have Tensioner Assemblies. It is these five belts that should be checked.

Maintenance Schedule

Inspect the Timing Belt every 1000K cycles.

Procedure

Do the following to inspect the Timing Belts.

1. Inspect all timing belts for wear, missing teeth, frayed edges, and cracks.
2. For replacement, see ARP 2.2 *Timing Belt Replacement*
3. Check for proper deflection of belts.
The belts should be slightly loose with approximately 1/4" deflection [1].
Belts that are too loose will not drive properly and belts that are too tight can wear out prematurely or damage their driven components.

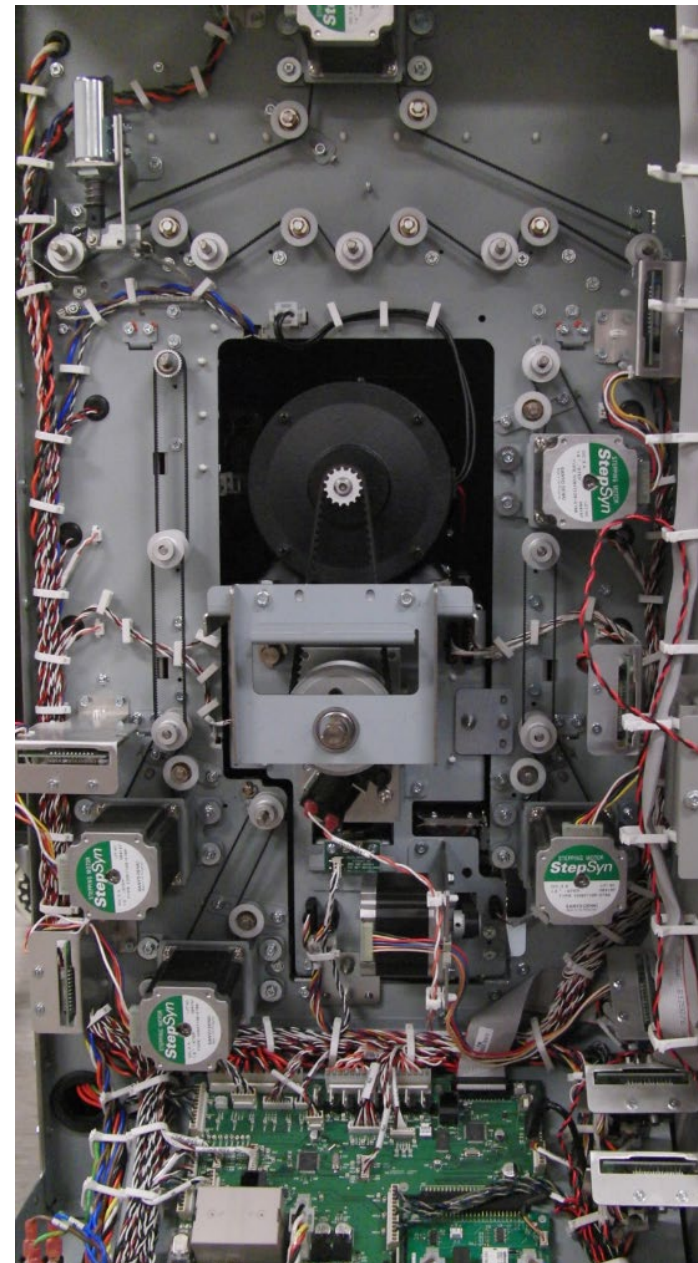

GP 6.22 Solenoid Cleaning and Inspection

Do the following to inspect and clean the Solenoids every 1000K cycles.

1. Open the front the door and insert an Interlock Cheater into the Punch Door interlock.

WARNING

Moving Parts, keep hands clear of nips and the belts when the Interlock Cheater is inserted.

2. Do GP 6.2.6 *SOLENOIDS Check* to activate and deactivate the affected solenoid.

When the solenoid is not activated, the idler roller should be able to rotate freely and in turn will drive the drive roller.



not activated



fully activated

When the solenoid is fully activated, the idler roller should completely lift off and not be able to drive the drive roller.

NOTE: Disengaging solenoid modules need to be replaced every 5 million cycles.

3. Clean the solenoid and surrounding area with a vacuum cleaner and canned air.

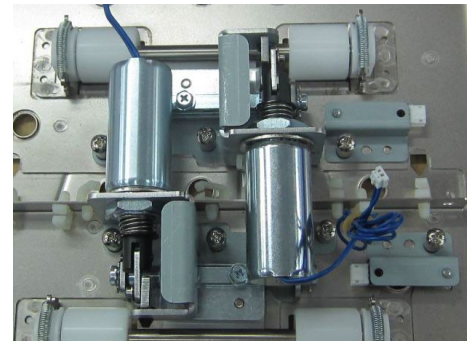

1. Make sure the solenoid is clean and dry.
2. Inspect for dirt or obstructions, wear or a damage spring.
3. Inspect and ensure the Solenoid linkage moves freely. Press linkage down and release. Linkage should return.

Note: Do not apply lubricants to the solenoid or linkage.

GP 6.23 Alignment Carriage Rails Cleaning

Do this procedure to clean the Alignment Carriage Rails.

Preventative Maintenance:

Do this every 500K cycles.

Procedure

1. Do ARP 3.1.1 to remove the Punch Module
2. Use a can of compressed air to remove dust from the alignment carriage rails. The carriage can be moved back and forth on the rails to clean the entire surface. Alternately, a soft cloth and alcohol can be used.

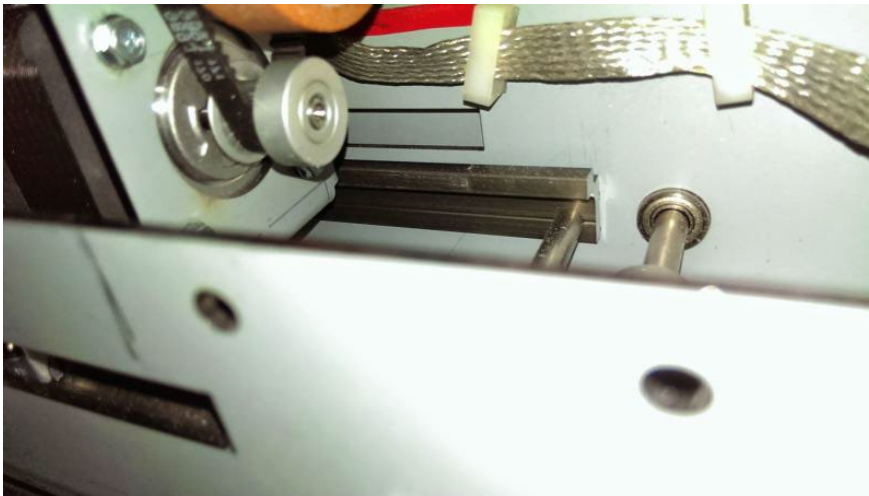

Important Note: DO NOT use any lubricant on the rail.

3. Once the rails are cleaned, check the motion of Alignment carriage on the rails. It should move when a force less than 2kgf is applied. If there is binding in the rails, replace the Alignment Carriage sub-assembly.
4. Do ARP 3.1.2 to install the Punch Module.

GP 6.24 Punch Clutch Inspection and Cleaning

Use this procedure to inspect and clean the punch clutch every 1000K cycles.

If the Punch Module is removed from the machine for servicing other components, do all steps. Otherwise do all steps except step 9.

1. Disconnect the Power Cord.
2. Do ARP 1.6 to remove the Rear Cover.
3. With a cloth wipe the collar of the clutch and remove any oil from the surface.

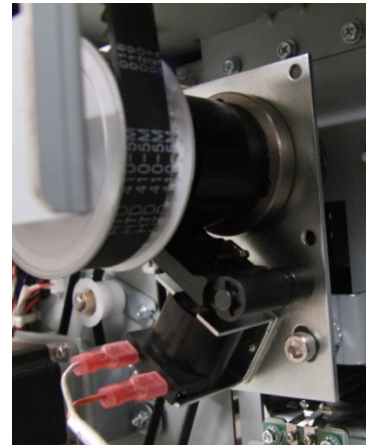

4. Inspect the collar stop and the metal insert pawl for any wear.



5. Check the tightness of (2) cone point set screws in the clutch.
6. Inspect the tightness of the M6 lock nut and M6 socket head cap screw.



7. Check the indexing of the Punch clutch, ADJ 1.5 Punch Clutch Indexing.
8. Do ARP 1.6 to install the Rear Cover,
9. Connect the Power Cord.
10. Do GP 6.2.8 FUNCTION TESTS (Cycle Punch, Aligner Test, Fan Test).

GP 6.25 Diverter Solenoid Assembly Inspection

Use this procedure to inspect the Diverter Solenoid Assembly every 1000K cycles.

1. Disconnect the Power Cord.
2. Do ARP 1.6 to remove the Rear Cover.
3. Clean the Solenoid and surrounding area with a vacuum cleaner and canned air.
4. Make sure the solenoid is clean and dry.
5. Raise the Diverter Solenoid by hand and release it. The Diverter should fall freely. Make sure the linkage operates smoothly.



6. Open the front door and insert an Interlock Cheater into the Punch Door Interlock switch
7. Press the Power Switch to the on position.

Warning

Moving Parts, keep hands clear of nips and the belts when the Interlock is cheater is inserted.

8. Do GP 6.2.6 SOLENOIDS to activate and deactivate Solenoid SOL1. The diverter gate should rise and fall when SOL1 is cycled.

GP 6.26 Die Set Recognition Board Clips Inspection

Use this procedure to Inspect and clean the Die Set recognition board clips every 1000K cycles.

1. Press the Power Switch to the off position.
2. Disconnect the Power Cord.
3. Do ARP 1.6 to remove the Rear Cover.
4. Inspect the Die Set Recognition reader spring clips to check if they are bent. When a die set is inserted, the spring clips should deform and fully contact the Die Set Recognition Board in the Die Set .

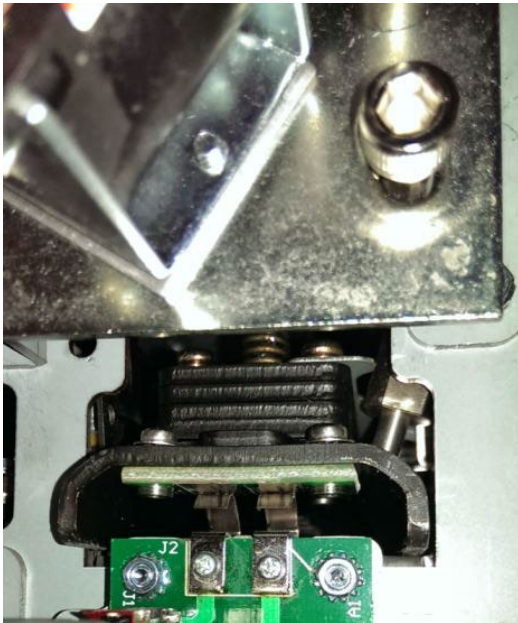

5. Wipe the spring clips with a clean cloth.
6. Do ARP1.6 to install rear cover

GP 6.27 Die Lock Mechanism and Die Rail Springs Inspection

Use this procedure to inspect the Die lock mechanism every 1000K cycles

1. Press the Power Switch to the off position.
2. Disconnect the Power Cord.
3. Do ARP 1.6 to remove the Rear Cover.
4. Do ARP 3.1.1 to remove the Punch Module.
5. Raise the die lock plunger by hand to inspect if there is a heavy spring force. There is an internal spring in the mechanism that provides the locking load. The load is quite heavy and the plunger may not move up. This is normal and can be verified again during Step 10.



6. Inspect (4) plastic bushings in the Die lock brackets. (2) in the front and (2) in the back.



7. Inspect the surface of the cam and cam follower pad, if there is any debris, clear it.
8. Inspect the (2) external compression springs.
9. Inspect the Die rail springs. The tip of the springs should be in contact with the side face of the die rail.

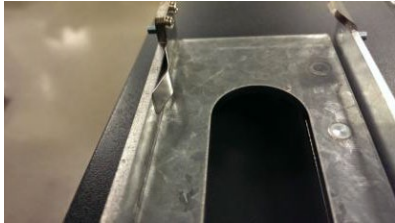

Good Spring

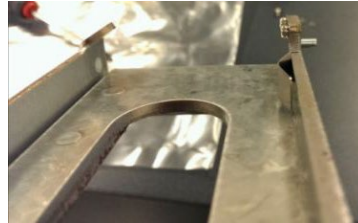

Deformed Spring

10. Insert a Die set in the die rail and lock the Die set and check if the tip contacts the die set base plate only. The Die lock mechanism should not contact anywhere else.
11. The Die Set should also slide in easily deforming the Die rail springs.

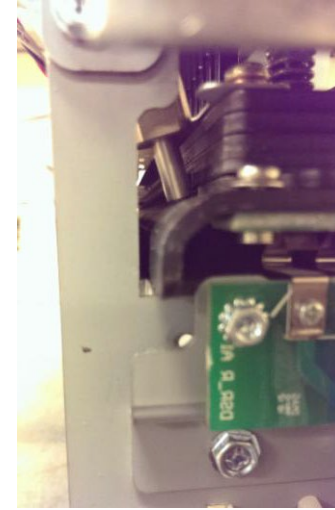

General Information

Principle of Operation

The Stream Punch VFX is a machine that punches various die set hole patterns into single sheets of paper. The machine is placed between a printer or copier and a finisher. The punch has two paper paths.

- The punch path.
- The bypass section.

Punch Path

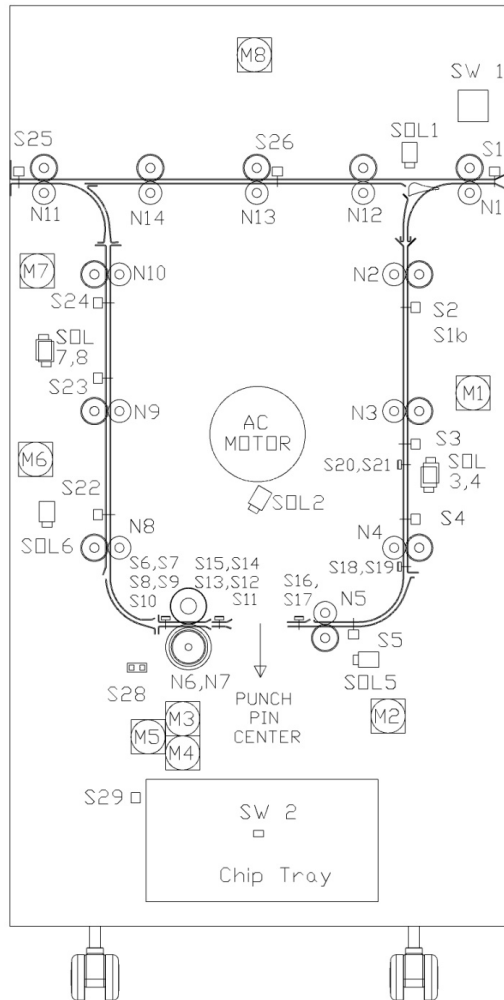

If the Punch is enabled, the transport and punch motors are started, and the Divert Solenoid SOL 1 is activated to direct the sheets into the punch path.

There are two modes of operation Single Punch and Double Punch.

Single Punch

The sheet enters the Punch at roller N1 running at printer line speed.

When the lead edge of the sheet reaches Sensor S5 (plus a delay to ensure the sheet is in roller N5) the sheet is accelerated to system speed of 1300mm/s.

The sheet enters the steering rollers N6 & N7 and the angle of the sheet is measured by Sensors S6-S10 and is then de-skewed by rollers N6 & N7.

After deskew, the front edge of the sheet is moved to alignment sensor S11-S15.

The sheet is transported by N6 & N7 until the trail edge is close to the Backgate Sensors S16 & S17.

The sheet is slowed and moves until the trail edge is detected at Sensors S16 & S17, at which point it moves a further set number of steps (backgate) and stops.

The sheet is punched on the trail edge.

Once the punch cycle is complete the sheet is accelerated by N6 & N7 to the system line speed.

Once the lead edge hits S24 (plus a delay to ensure the sheet is in roller N10) the sheet is decelerated to the printer line speed.

Double Punch (Mid punch + trail edge punch)

The sheet enters at roller N1 running at printer line speed.

When the lead edge of the sheet reaches S5 (plus a delay to ensure the sheet is in roller N5) the sheet is accelerated to system speed of 1300mm/s.

The sheet enters the steering rollers N6 & N7 and the angle of the sheet is measured by S6-S10 and then deskewed by rollers N6 & N7.

After deskew the front edge of the sheet is moved to alignment sensor S11-S15.

The sheet is transported by N6 & N7 until the trail edge is close to the Backgage Sensors S18 & S19 for SEF A4/SEF LTR and S19 & S20 for SEF A3/11x17.

The sheet is slowed and moves until the trail edge is detected at sensors S18 & S19 for SEF A4/SEF LTR and S19 & S20 for SEF A3/11x17, at which point it moves a further set number of steps (backgage) and stops.

The sheet is mid-punched.

Once the punch cycle is complete the sheet is accelerated by N6 & N7 to the system line speed.

The front edge of the sheet is moved to Alignment Sensors S11-S15.

When the trail edge is close to the Backgage Sensors S16 & S17 the sheet is slowed and moves until the trail edge is detected at S16 & S17, at which point it moves a further set number of steps (backgage) and stops.

The sheet is punched on the trail edge.

Once the punch cycle is complete the sheet is accelerated by N6 & N7 to the system line speed.

Once the lead edge hits S24 (plus a delay to ensure the sheet is in roller N10) the sheet is decelerated to the printer line speed.

Bypass Path

If the Punch is not enabled, the Advanced Punch will run in bypass mode (no punching).

The sheet enters the Punch at roller N1 running at printer line speed.

The Divert Solenoid SOL 1 is not activated, so the sheets are directed into the bypass path.

When the lead edge of the sheet reaches nip 13, the sheet is detected by Bypass Sensor S26,

The sheet is transported by N12, N13, N14, and N11 until the trail edge of the sheet reaches Exit Sensor S26.

Refer to the electrical wiring information and to Parts List *PL 2.7, Frame Assembly Sensors*, when reading the following material on Inputs and Output signals.

Table 6.1 Input Devices

Input	Type	Function
Sensor S1	Optical	Entrance Sensor
Sensor S2	Optical	Entrance Idler Panel Sensor
Sensor S3	Optical	Entrance Idler Panel Sensor
Sensor S4	Optical	Entrance Idler Panel Sensor
Sensor S5	Optical	Accel Sensor
Sensor S6	Circuit Board	Skew Board Sensor
Sensor S7	Circuit Board	Skew Board Sensor
Sensor S8	Circuit Board	Skew Board Sensor
Sensor S9	Circuit Board	Skew Board Sensor
Sensor S10	Circuit Board	Skew Board Sensor
Sensor S11	Circuit Board	Alignment Sensor
Sensor S12	Circuit Board	Alignment Sensor
Sensor S13	Circuit Board	Alignment Sensor
Sensor S14	Circuit Board	Alignment Sensor
Sensor S15	Circuit Board	Alignment Sensor
Sensor S16	Circuit Board	Backgage Sensor
Sensor S17	Circuit Board	Backgage Sensor
Sensor S18	Circuit Board	Large Mid Punch Backgage Sensor
Sensor S19	Circuit Board	Large Mid Punch Backgage Sensor
Sensor S20	Circuit Board	XL Mid Punch Backgage Sensor
Sensor S21	Circuit Board	XL Mid Punch Backgage Sensor
Sensor S22	Optical	Exit Idler Panel Sensor
Sensor S23	Optical	Exit Idler Panel Sensor
Sensor S24	Optical	Exit Idler Panel Sensor
Sensor S25	Optical	Exit Sensor
Sensor S26	Optical	Bypass Sensor
Sensor S28	Optical	Align Home Sensor

Input	Type	Function
Sensor S29	Emitter/Receiver	Chip Tray Full Emitter/Receiver
Solenoid SOL1	Mechanical	Divert Solenoid
Solenoid SOL2	Mechanical	Punch Clutch Solenoid
Solenoid SOL3	Mechanical	Entrance Idler Solenoid
Solenoid SOL4	Mechanical	Entrance Idler Solenoid
Solenoid SOL5	Mechanical	Accel Idler Solenoid
Solenoid SOL6	Mechanical	Exit Idler Solenoid
Solenoid SOL7	Mechanical	
Solenoid SOL8	Mechanical	
Switch SW1	Mechanical	Punch Door Interlock Switch, no machine movement if door is open
Switch SW	Mechanical	Chip Tray Home Switch

Glossary of Terms

These terms are common to the punch and bindery industry.

Alignment	A predetermined distance of the top punched hole from the side edge of the sheet (viewed from the punch output orientation).
Backgauge	A predetermine distance from the trail edge of the sheet of paper to the punched hole(s).
Deskew	The term used to describe the process of aligning the sheet of paper until it is parallel to the paper path.
Skew	The term used to describe the fact that the sheet of paper is not parallel to the paper path.

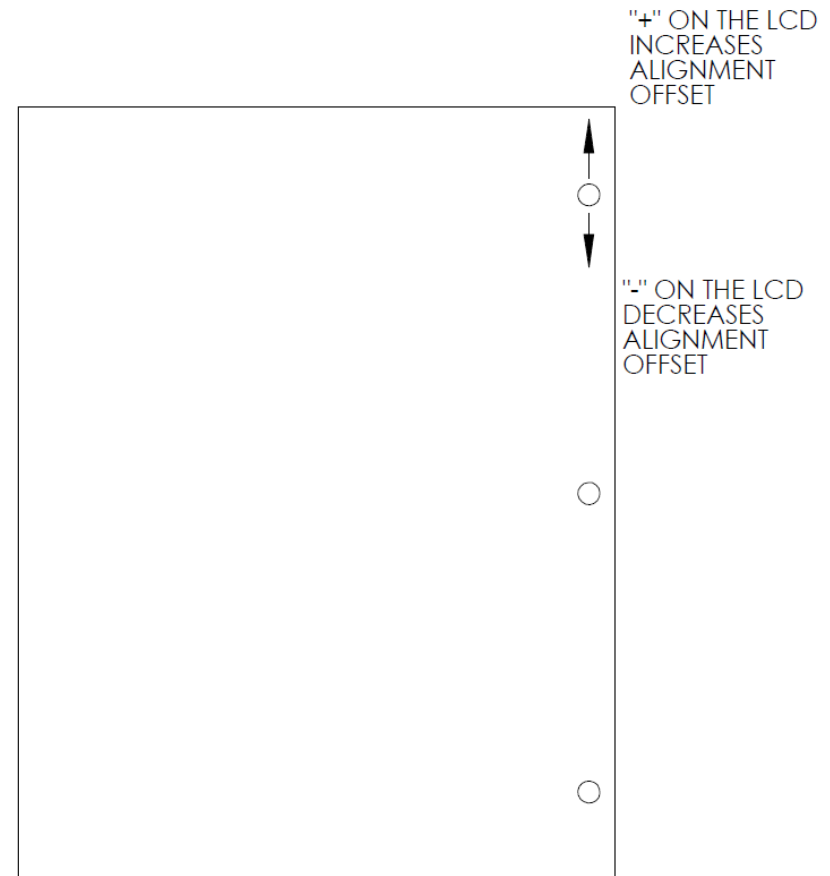
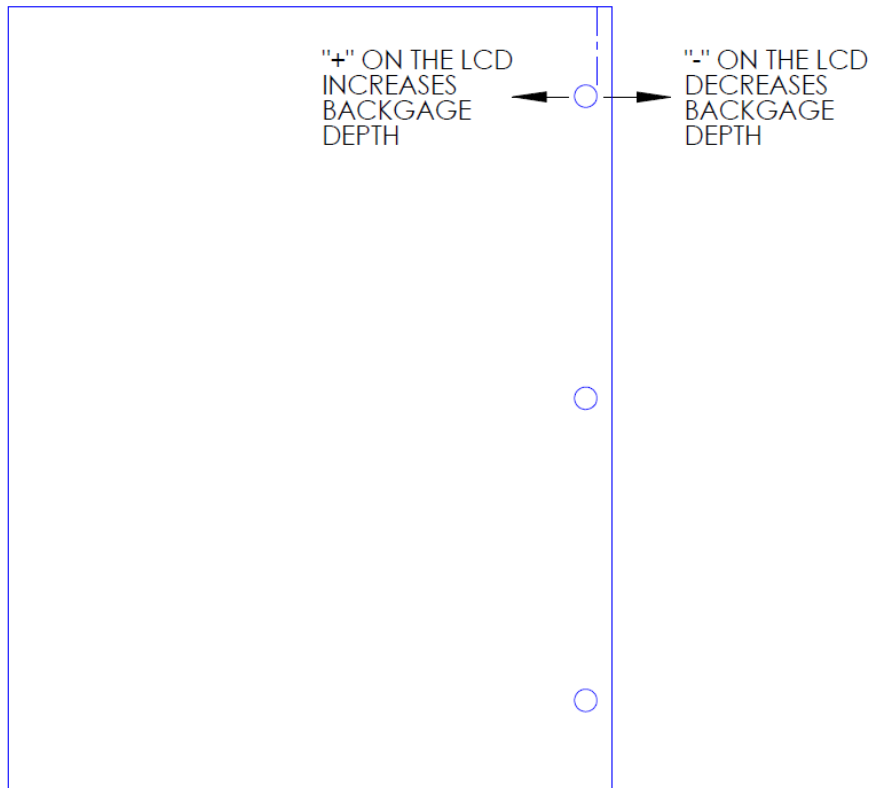

Specifications

Speed	Up to 144 sheets per minute
Punch Sheet Size and Edge LEF- Long Edge Fed SEF- Short Edge Fed	US Sizes LTR LEF LTR SEF LTR SEF Double Punch Statement LEF Legal SEF Ledger SEF Ledger SEF Double Punch ISO sizes A4 LEF A4 SEF A4 SEF Double Punch A5 LEF A3 SEF A3 SEF Double Punch
Tab Stock	US Sizes LTR, with 3,4,5,8 and 10 tabs Statement, with 3 and 5 tabs ISO Sizes A4, with 5 and 10 tabs A5, with 3 and 5 tabs
Paper Stock	Plain: 75gsm - 300gsm (20# bond to 110# cover) Coated: 120gsm - 300gsm (32# bond to 110# cover)
Clear Cover	7mil
Bypass mode stock and sizes	Up to 450 gsm.
Punch Capacity	Single Sheet
Power Supply	115V, 60Hz, Single Phase 230V, 50Hz, Single Phase
Electrical	Amps and Frequency
Safety Certification	cULus
Dimensions	L: 775mm; W: 445mm; H: 1020mm L: 30.5"; W: 17.5"; H: 40.2"
Weight	95 kg 210 lbs

Die Sets

The StreamPunch VFX uses a variety of easily interchangeable die sets that allow you to punch documents in line for several different binding styles.

Please note that each punching style listed below requires a separate die set for the StreamPunch VFX. The StreamPunch VFX can hold up to three Die Sets in its cabinet (one in the operating slot and two in the storage area).

Die Sets will decrease in performance over time based on the types of stocks and weights that are being punched.

The expected life of a die set is 750K punches when punching 20 lb bond (75 gsm paper).

Die Sets should be regarded as a long-term supply item.

To purchase additional or replacement Die Sets, contact your authorized sales representative.



Die Sets List

By selecting the appropriate die set, you can use your StreamPunch VFX to punch documents in any of the binding styles indicated in the tables below.

Die Set Description

For Plastic Comb Binding:



* When the Plastic Comb binding die is used in the 21 hole configuration on A4 width paper (297mm), there is the potential for the outer edge of holes 1 and 21 to be torn. The theoretical paper edge should be 1.62mm from the edge of the sheet. This event is dependent on paper type, paper width and hole alignment optimization. To avoid this issue, it is recommended to use a 20 hole configuration instead. 20 hole comb binding supplies are commonly available from GBC and other manufacturers and are considered more optimal than the [21 hole configuration](#).

For Twin Loop™ Binding:

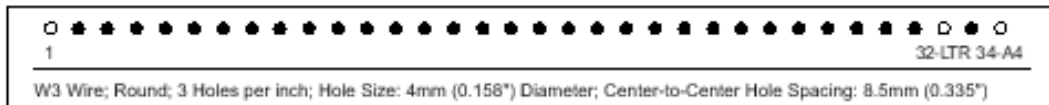
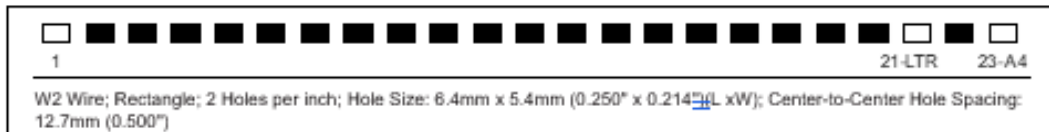
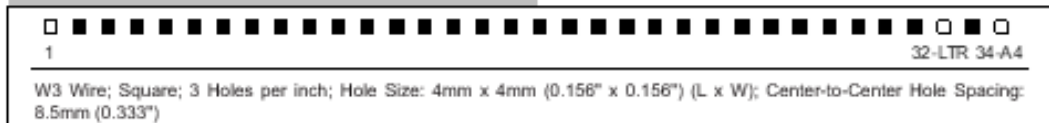

GBC Part Number

Die, GBC, Comb Bind	7723480A
Die, GBC, Comb Bind, HD	7723488A

Die, GBC, Wire 3.1, Sq.	7723482A
-------------------------	----------

Die, GBC, Wire 2.1, Sq.	7723481A
-------------------------	----------

Die, GBC, eWire, 3:1, Sq.	7723485A
---------------------------	----------

Die, GBC, Wire, 3:1, Rnd.	7723472A
---------------------------	----------

Die, GBC, Wire, 2:1, Rnd.	7723471A
---------------------------	----------

Die, GBC, eWire, 3:1, Rnd.	7723484A
----------------------------	----------

Die Sets List (cont'd)

By selecting the appropriate die set, you can use your StreamPunch VFX to punch documents in any of the binding styles indicated in the tables below.

For Color Coil™ Binding:



C4 Coil; Round; 4 Holes per inch; Hole Size: 4.4mm (0.174") Diameter; Center-to-Center Hole Spacing: 6.3mm (0.2475")

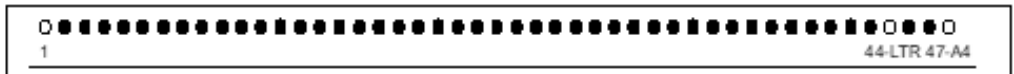

C4 Coil; Oval; 4 Holes per inch; Hole Size: 4mm x 5mm (0.158" x 0.197") (L x W); Center-to-Center Hole Spacing: 6.3mm (0.2475")

For Velo® Bind:



VB Velobind®; Round; 1 Hole per inch Hole Size: 3.2mm (0.125") Diameter; Center-to-Center Hole Spacing: 25.4mm (1")



VB Velobind®; Round; 1 Hole per inch Hole Size: 3.2mm (0.126") Diameter; Center-to-Center Hole Spacing: 25.4mm (1")

For Loose Leaf Binding:

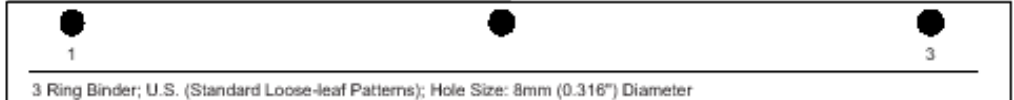

3 Ring Binder; U.S. (Standard Loose-leaf Patterns); Hole Size: 8mm (0.316") Diameter

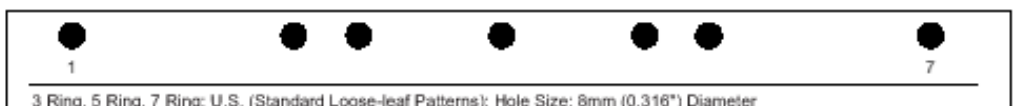

3 Ring, 5 Ring, 7 Ring; U.S. (Standard Loose-leaf Patterns); Hole Size: 8mm (0.316") Diameter

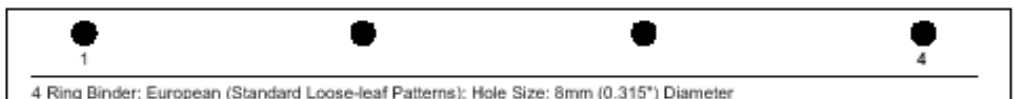

4 Ring Binder; European (Standard Loose-leaf Patterns); Hole Size: 8mm (0.315") Diameter



4 Ring Binder; European (Standard Loose-leaf Patterns); Hole Size: 6.5mm (0.256") Diameter

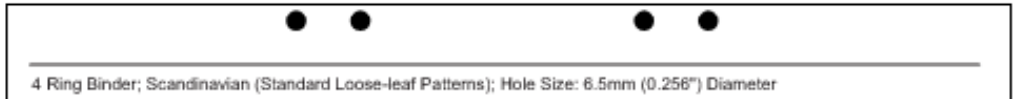

4 Ring Binder; Scandinavian (Standard Loose-leaf Patterns); Hole Size: 6.5mm (0.256") Diameter

Die, GBC, Coil, Rnd.	7723470A
Die, GBC, Coil, Rnd, HD	7723486A

Die, GBC, Coil, Oval	7723483A
----------------------	----------

Die, GBC, Velobind®, 11 Holes, Ltr.	7723478A
-------------------------------------	----------

Die, GBC, Velobind®, 12 Holes, A4.	7723479A
------------------------------------	----------

Die, GBC, 3 Hole, 8mm	7723473A
Die, GBC, 3 Hole, 8mm, HD	7723487A

Die, GBC, 3/5/7 Hole, 8mm	7723474A
---------------------------	----------

Die, GBC, 4 Hole, 8mm	7723475A
-----------------------	----------

Die, GBC, 4 Hole, 6.5mm	7723476A
-------------------------	----------

Die, GBC, 4 Hole, Scan	7723477A
------------------------	----------

Tools

Tools recommended for service of the Stream Punch VFX:

Standard Tools (metric)

- 7mm Nut Driver
- 5.5mm Nut Driver
- 7mm Open End Wrench
- 5.5mm Open End Wrench
- Needle Nose Pliers
- Phillips Screwdriver
- Flathead Screwdriver
- Wire Cutters
- Metric Allen Key Set (1.5mm, 2mm, 2.5mm, 3mm, 4mm, 5mm)

Other Recommended Tools and Supplies

- 0.25mm, 1mm, and 3mm Shim Gauges
- 0 to 2 kgf Tension meter (also called Spring gage)

Lubrication

For General lubrication please see the following sections

- GP 6.7.3, Die Set Lubrication
- GP 6.20, Punch Drive Cam Lubrication

Cleaning Materials

Use a clean, soft, lint-free cloth to clean the following.

- GP 6.8, External Cleaning
- GP 6.9, Internal Cleaning - small paintbrush

Use a soft cloth and alcohol to clean the following.

- GP 6.14, Idler Roller Inspection and Cleaning
- GP 6.15, Drive Roller Inspection and Cleaning

Use canned air or soft cloth to clean the following.

- GP 6.17, Optical Sensor Cleaning

- GP 6.23, Alignment Carriage Rails

Use canned air or vacuum cleaner to clean the following.

- GP 6.22, Solenoid Cleaning and Inspection

Serial Numbers

The Stream Punch VFX Serial Number is located inside the Front Door on the front frame just below the Bypass Section

This page intentionally left blank.

Notes:

Section Contents

Wiring Data

Title	Page
System Wiring (7724128)	7-3
Plug Jack connectors	7-3

This page intentionally left blank.

System Wiring (7724128)

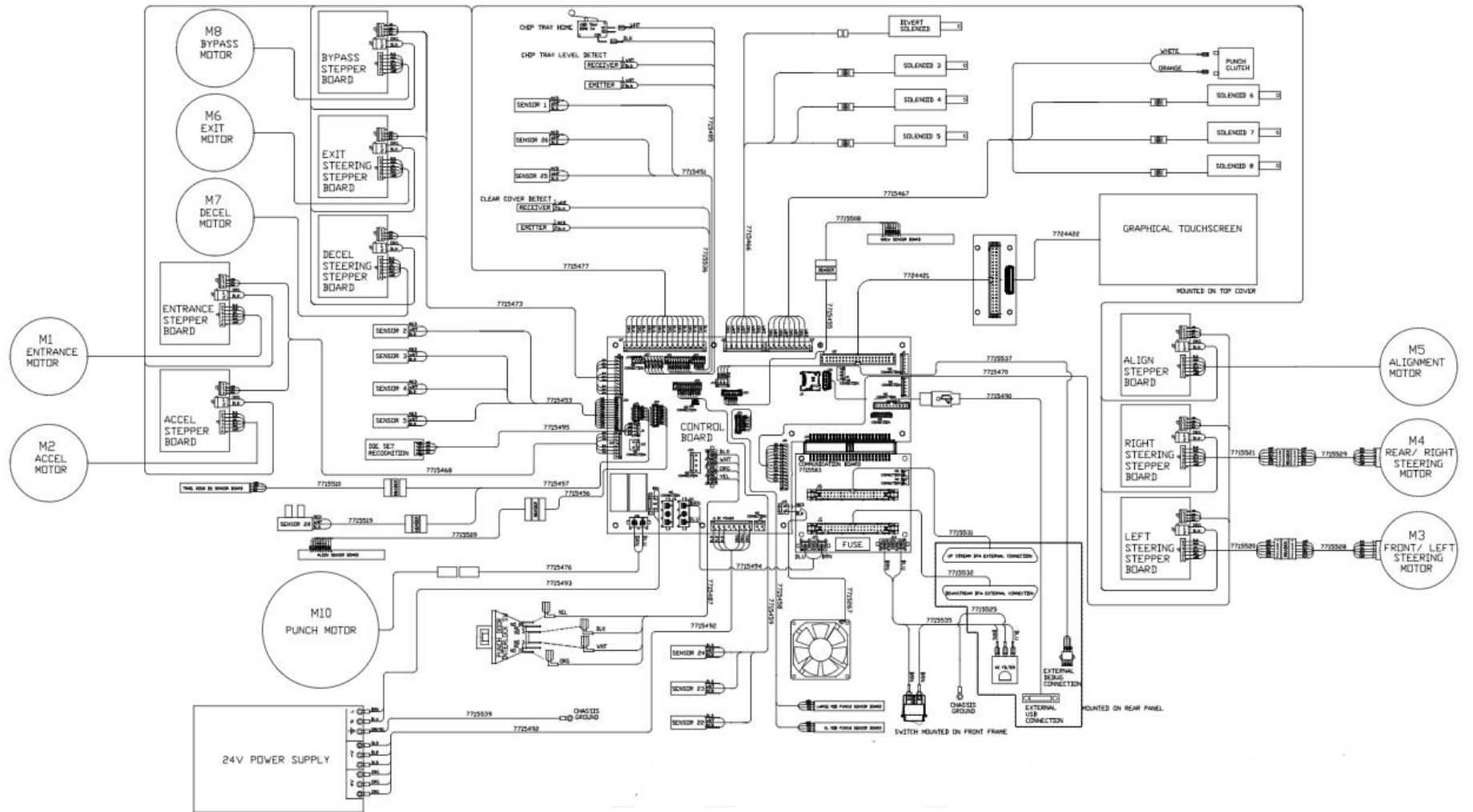

Plug Jack connectors

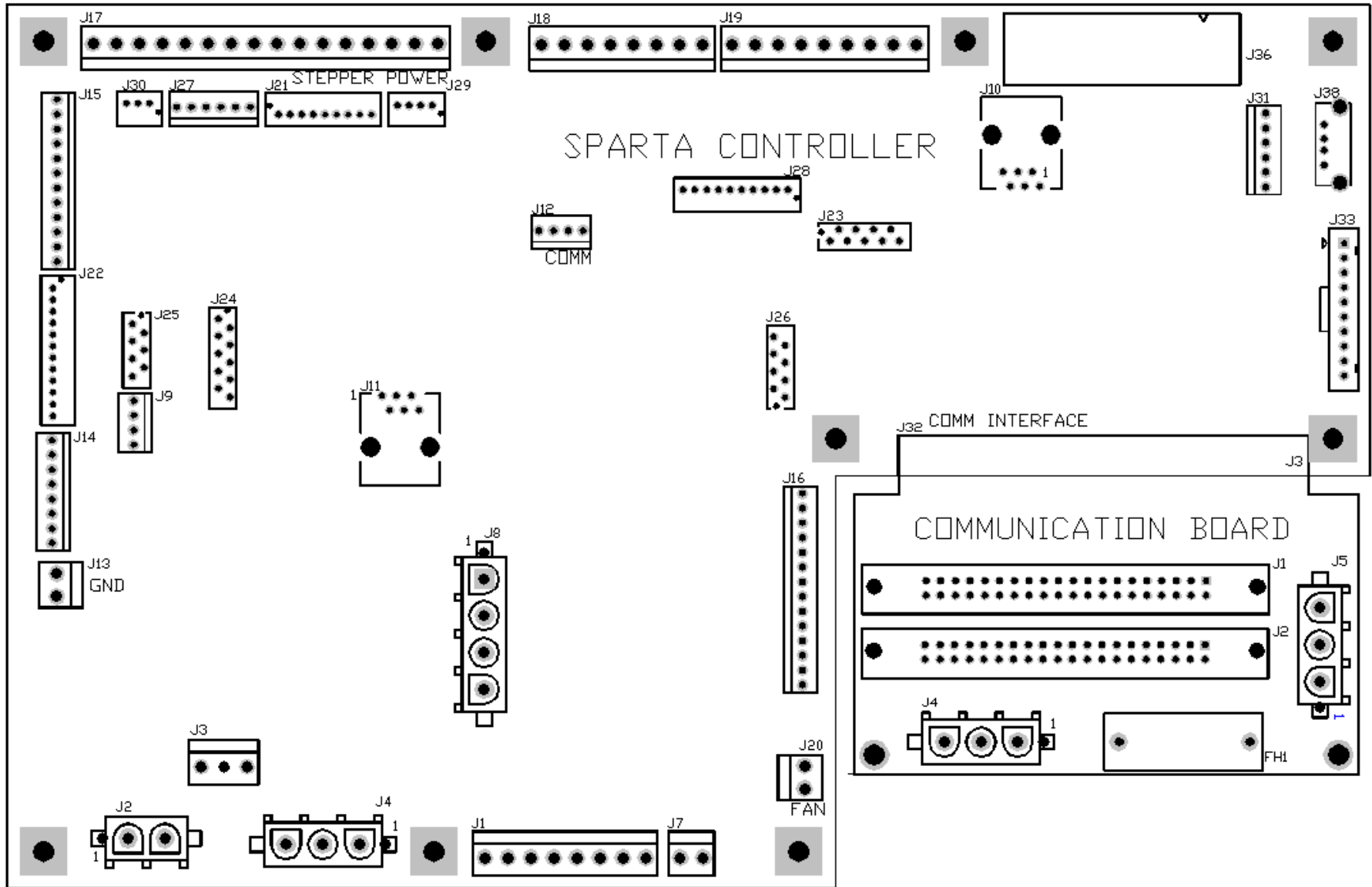

8. Installation Instructions

Refer to separate document

7723674 - MANUAL, INSTALL, eWIRE VFX & STREAMPUNCH VFX
